

ASSESSMENT OF DAM SAFETY OF COAL COMBUSTION SURFACE IMPOUNDMENTS FINAL REPORT



**CPS Energy
J.T. Deely Power Plant
San Antonio, Texas**

Prepared for
*U.S. Environmental
Protection Agency
Washington, D.C.*

February 2014
Revised May 2014
Revised June 2014

CDM Smith Project No.:
93083.1801.044.SIT.DEELY

**CDM
Smith**

Table of Contents

Section 1 Introduction, Summary Conclusions and Recommendations

1.1 Introduction	1-1
1.2 Purpose and Scope	1-1
1.3 Conclusions and Recommendations.....	1-2
1.3.1 Conclusions.....	1-2
1.3.1.1 Conclusions Regarding Structural Soundness of the CCW Impoundments.....	1-2
1.3.1.2 Conclusions Regarding the Hydrologic/Hydraulic Safety of CCW Impoundments.....	1-2
1.3.1.3 Conclusions Regarding Adequacy of Supporting Technical Documentation.....	1-3
1.3.1.4 Conclusions Regarding Description of the CCW Impoundments	1-3
1.3.1.5 Conclusions Regarding Field Observations	1-3
1.3.1.6 Conclusions Regarding Adequacy of Maintenance and Methods of Operation.....	1-3
1.3.1.7 Conclusions Regarding Adequacy of Surveillance and Monitoring Program	1-3
1.3.1.8 Conclusions Regarding Suitability for Continued Safe and Reliable Operation.....	1-4
1.3.2 Recommendations.....	1-4
1.3.2.1 Recommendations Regarding the Hydrologic/Hydraulic Safety	1-4
1.3.2.2 Recommendations Regarding the Technical Documentation for Structural Stability	1-4
1.3.2.3 Recommendations Regarding Field Observations.....	1-4
1.3.2.4 Recommendations Regarding Adequacy of Maintenance and Methods of Operation	1-4
1.3.2.5 Recommendations Regarding Surveillance and Monitoring Program.....	1-4
1.3.2.6 Recommendations Regarding Continued Safe and Reliable Operation.....	1-4
1.4 Participants and Acknowledgment.....	1-5
1.4.1 List of Participants.....	1-5
1.4.2 Acknowledgment and Signature	1-5

Section 2 Description of the Coal Combustion Waste (CCW) Impoundment(s)

2.1 Location and General Description	2-1
2.1.1 Horizontal and Vertical Datum	2-2
2.1.2 Site Geology	2-2
2.2 Coal Combustion Residue Handling.....	2-2
2.3 Size and Hazard Classification	2-3
2.4 Amount and Type of Residuals Currently Contained in the Unit(s) and Maximum Capacity.....	2-4
2.5 Principal Project Structures.....	2-4
2.6 Critical Infrastructure within Five Miles Down Gradient.....	2-5

Section 3 Summary of Relevant Reports, Permits and Incidents

3.1 Summary of Reports on the Safety of the CCW Impoundments.....	3-1
3.2 Summary of Local, State, and Federal Environment Permits	3-1
3.3 Summary of Spill/Release Incidents	3-1

Section 4 Summary of History of Construction and Operation

4.1 Summary of Construction History.....	4-1
4.1.1 Impoundment Construction and Historical Information.....	4-1
4.1.2 Significant Changes/Modifications in Design since Original Construction.....	4-1
4.1.3 Significant Repairs/Rehabilitation since Original Construction.....	4-2
4.2 Summary of Operational Procedures.....	4-2
4.2.1 Original Operating Procedures	4-2
4.2.2 Significant Changes in Operational Procedures and Original Startup.....	4-2
4.2.3 Current CCW Impoundment Configuration	4-3
4.2.4 Other Notable Events since Original Startup	4-3

Section 5 Field Observations

5.1 Project Overview and Significant Findings (Visual Observations).....	5-1
5.2 North Bottom Ash Pond.....	5-2
5.2.1 Crest.....	5-2
5.2.2 Interior Slopes.....	5-2
5.2.3 Exterior Slopes.....	5-2
5.2.4 Inlet Piping.....	5-2
5.2.5 Outlet Structures	5-3
5.3 South Bottom Ash Pond	5-3
5.3.1 Crest.....	5-3
5.3.2 Interior Slopes.....	5-3
5.3.3 Exterior Slopes	5-3
5.3.4 Inlet Piping.....	5-4
5.3.5 Outlet Structures	5-4
5.4 Evaporation Pond.....	5-4
5.4.1 Crest.....	5-4
5.4.2 Interior Slopes.....	5-4
5.4.3 Exterior Slopes.....	5-4

Section 6 Hydrologic/Hydraulic Safety

6.1 Impoundment Hydraulic Analysis.....	6-1
6.2 Adequacy of Supporting Technical Documentation	6-2
6.3 Assessment of Hydrologic/Hydraulic Safety	6-2

Section 7 Structural Stability

7.1 Supporting Technical Documentation.....	7-1
7.1.1 Stability Analyses and Load Cases Analyzed.....	7-1
7.1.2 Design Parameters and Dam Materials	7-2
7.1.3 Uplift and/or Phreatic Surface Assumptions	7-3
7.1.4 Factors of Safety and Base Stresses	7-3
7.1.5 Liquefaction Potential.....	7-4
7.1.6 Critical Geological Conditions.....	7-5

7.2 Adequacy of Supporting Technical Documentation	7-5
7.3 Assessment of Structural Stability.....	7-5
Section 8 Adequacy of Maintenance and Methods of Operation	
8.1 Operating Procedures.....	8-1
8.2 Maintenance of the Dam and Project Facilities.....	8-1
8.3 Assessment of Maintenance and Methods of Operations.....	8-1
8.3.1 Adequacy of Operating Procedures.....	8-1
8.3.2 Adequacy of Maintenance	8-2
Section 9 Adequacy of Surveillance and Monitoring Program	
9.1 Surveillance Procedures	9-1
9.2 Instrumentation Monitoring.....	9-1
9.3 Assessment of Surveillance and Monitoring Program.....	9-1
9.3.1 Adequacy of Inspection Programs.....	9-1
9.3.2 Adequacy of Instrumentation Monitoring Program	9-1
Section 10 Reports and References	

Appendices

- Appendix A – RKCI Geotechnical Engineering Study
- Appendix B – USEPA Checklists
- Appendix C – Documentation from CPS
- Appendix D – Photographs

Tables

Table 2-1 – Summary of Impoundments Approximate Dimension and Size.....	2-2
Table 2-2 – USACE ER 1110-2-106 Size Classification.....	2-3
Table 2-3 – Recommended Impoundment Hazard Classification Ratings	2-3
Table 4-1 – Approximate Crest Elevations and Surface Areas	4-3
Table 5-1 – Approximate Precipitation Prior to Site Visit.....	5-1
Table 7-1 – Recommended Minimum Safety Factors.....	7-2
Table 7-2 – Soil Parameters Used in RKCI’s Steady-State Slope Stability Analyses	7-3
Table 7-3 – Soil Parameters Used in RKCI’s Seismic Slope Stability Analyses.....	7-3
Table 7-4 – Safety Factors Computed for Various Stability Conditions.....	7-4

Figures

- Figure 2-1 – Vicinity Map
- Figure 2-2 – Critical Infrastructure Plan
- Figure 2-3– Site Plan
- Figure 5-1 – North Bottom Ash Pond
- Figure 5-2 – South Bottom Ash Pond
- Figure 5-3 – Ash Pond Outfalls
- Figure 5-4 – Evaporation Pond

Section 1

Introduction, Summary Conclusions and Recommendations

1.1 Introduction

On December 22, 2008, the dike of a coal combustion waste (CCW) ash pond dredging cell failed at a facility owned by the Tennessee Valley Authority in Kingston, Tennessee. The failure resulted in a spill of over one billion gallons of coal ash slurry, which covered more than 300 acres, damaging infrastructure and homes. In light of the dike failure, the United States Environmental Protection Agency (USEPA) is assessing the stability and functionality of existing CCW impoundments at coal-fired electric utilities to ensure that lives and property are protected from the consequences of a failure.

This assessment of the stability and functionality of the CPS Energy J.T. Deely Power Plant ash CCW impoundments is based on a review of available documents, site assessments conducted by CDM Smith on August 27 and 28, 2012, and technical information provided subsequent to the site visit. In summary, the North and South Bottom Ash Ponds and Evaporation Basin's embankments are classified as **SATISFACTORY** based on static and seismic engineering studies following the best professional engineering practice to support acceptable safety factors under normal loading conditions (static, hydrologic, seismic) in accordance with the applicable safety regulatory criteria.

It is critical to note that the condition of the embankment(s) depends on numerous and constantly changing internal and external conditions, and is evolutionary in nature. It would be incorrect to assume that the present condition of the embankment(s) will continue to represent the condition of the embankment(s) at some point in the future. Only through continued care and inspection can there be likely detection of unsafe conditions.

1.2 Purpose and Scope

CDM Smith was contracted by the USEPA to perform site assessments of selected surface impoundments. As part of this contract, CDM Smith conducted site assessments of the North and South Bottom Ash Ponds and Evaporation Pond at the J.T. Deely Power Plant (Plant) site owned by CPS Energy (CPS). These ponds are located on the east and north sides of the site. The purpose of this report is to provide the results of the assessments and evaluations of the conditions, and potential for waste release from the CCW impoundments. The Evaporation Pond receives boiler chemical cleaning waste from CPS's J.T. Deely Power Plant and their J.K. Spruce Power Plant. Accordingly, the assessment of the Evaporation Pond is also included in a separate report by CDM Smith prepared for the J.K. Spruce Power Plant.

Site visits were conducted by CDM Smith representatives on August 27 and 28, 2012 to collect relevant information, inventory the impoundments, and perform visual assessments of the impoundments.

1.3 Conclusions and Recommendations

1.3.1 Conclusions

Conclusions are based on visual observations during site assessments on August 27 and 28, 2012 and review of technical documentation provided by CPS.

1.3.1.1 Conclusions Regarding Structural Soundness of the CCW Impoundments

A May 7, 2014 geotechnical report, prepared by Raba Kistner Consultants, Inc. (RKCI), was provided that included slope stability analyses for steady-state and seismic loading conditions of the North and South Bottom Ash Pond and Evaporation Pond embankments. The RKCI May 7, 2014 report supersedes RKCI's November 12, 2012 referenced in the CDM Smith's December 2012 "Assessment of Dam Safety of Coal Combustion Surface Impoundments, CPS Energy, J.T. Deely Power Plant". The RKCI May 7, 2014 report is included in **Appendix A**. The calculated factors of safety presented in the RKCI 2014, for the load conditions analyzed, met minimum required factors of safety outlined by the USACE in EM 1110-2-1902, Table 3-1 and seismic factors of safety by FEMA Federal Guidelines for Dam Safety, Earthquake Analyses and Design of Dams. The RKCI 2014 report did not present analyses for liquefaction potential, end of construction, and rapid drawdown loading conditions. RKCI stated in the 2014 report that the end-of-construction condition was not evaluated due to the age of the ash ponds. RKCI also stated that both rapid drawdown and erosion failures are considered to be of very low risk due to the embankment toe elevations (above EL 490 feet) with respect to the target pool elevation (EL 485 feet) and because they would pose no risk of environmental contamination, because the pond must empty for this condition to occur.

RKCI indicated in their May 2014 report that the soils beneath the existing berms have a very low risk of experiencing liquefaction due to earthquake. In their seismic slope stability analyses, RKCI used the mapped spectral response acceleration of 0.098g from the USGS web site calculator. RKCI further indicated in their 2014 report that the applied horizontal seismic load had a 4-to-6 % probability of exceedance in 50 years. USEPA guidelines specify that the mapped spectral response acceleration for an earthquake with 2% probability of exceedance in 50 years be used in seismic slope stability analyses. CDM Smith used USGS referenced maps, published in the 2010 ASCE-7 Standard, to determine the mapped spectral response acceleration for an earthquake with 2% probability of exceedance in 50 years. CDM Smith found the spectral response acceleration for the Deely site to be 0.075g. Accordingly, in CDM Smith's opinion, the response acceleration employed in RKCI's seismic analyses conforms to USEPA standards.

No apparent structural damage or evidence of previous repairs was observed in the CCW impoundments during CDM Smith's site visit. From visual observations, the embankments appeared structurally sound; however high water and solids level in the North Bottom Ash Pond and Evaporation Pond prevented observation of the interior embankment slopes during CDM Smith's visual observations and site assessments.

CDM Smith agrees with RKCI's rationale regarding embankment stability for end of construction, liquefaction potential, and rapid drawdown conditions.

1.3.1.2 Conclusions Regarding the Hydrologic/Hydraulic Safety of CCW Impoundments

Hydrologic/hydraulic (H & H) documentation provided by CPS included precipitation amounts for selected storm durations and return periods expected in the Calaveras Lake site area. A preliminary H & H evaluation performed by CDM Smith suggests there is enough storage capacity at current

operating pool levels for the North and South Bottom Ash Ponds, and the Evaporation Pond to safely store precipitation from the FEMA recommended rainfall events (0.1 percent annual chance exceedance flood for the significant hazard potential North and South Bottom Ash Ponds and 1 percent annual chance exceedance flood for the Evaporation Pond). Based on CDM Smith's preliminary evaluation the hydrologic/hydraulic safety of the impoundments appears to be adequate.

1.3.1.3 Conclusions Regarding Adequacy of Supporting Technical Documentation

CDM Smith has the following conclusions based on our review of the documentation provided by CPS:

- The RKCI documentation of the stability analyses for the North and South Bottom Ash Ponds and Evaporation Pond is considered adequate based on the following:
 - ✓ Steady-state and seismic stability analyses for of the North and South Bottom Ash Ponds and Evaporation Pond embankments are documented.
 - ✓ RKCI provided assessments of the embankments' liquefaction potential, and structural stability applicable for end of construction and sudden drawdown loading conditions. RKCI did not analyze liquefaction potential, end of construction and sudden drawdown loading conditions. As described above, CDM Smith agrees with RKCI's rationale for not performing analyses for these loading conditions.
- The hydrologic and hydraulic supporting documentation of North and South Bottom Ash Ponds and Evaporation Pond is considered inadequate based on the following:
 - ✓ H & H documentation provided by CPS included precipitation amounts for selected storm durations and return periods expected in the Calaveras Lake site area. No documentation was provided by CPS on the ability of the impoundments to store the FEMA-recommended design floods.
 - ✓ An evaluation to determine the required IDF and of the capacity of the North and South Bottom Ash Ponds and Evaporation Pond to withstand the design hydrologic/hydraulic events, without overtopping have not been provided.

1.3.1.4 Conclusions Regarding Description of the CCW Impoundments

The record drawings and descriptions of the CCW impoundments provided by CPS representatives appear to be consistent with the visual observations by CDM Smith during site assessment.

1.3.1.5 Conclusions Regarding Field Observations

During visual observations and site assessments, CDM Smith observed an area of erosion around a fence post at the north embankment crest. Dense vegetation and trees up to 8 inches in diameter was also observed on the exterior slope of the north embankment at the North Bottom Ash Pond. No significant deficiencies were observed at the South Bottom Ash Pond and Evaporation Pond.

1.3.1.6 Conclusions Regarding Adequacy of Maintenance and Methods of Operation

Current maintenance and operation procedures appear to be generally adequate, though they are not documented. There was no existing evidence of previous spills or release of impounded liquids outside the Plant property.

1.3.1.7 Conclusions Regarding Adequacy of Surveillance and Monitoring Program

Surveillance and monitoring procedures include checking the impoundments for deficiencies and recording pool levels for both the North and South Bottom Ash Ponds twice a day. No surveillance and

monitoring procedures exist for the Evaporation Pond. Instrumentation is not present for the North and South Bottom Ash Ponds or Evaporation Pond.

1.3.1.8 Conclusions Regarding Suitability for Continued Safe and Reliable Operation

Main embankments do not show evidence of unsafe conditions requiring immediate remedial efforts, although maintenance to correct deficiencies noted above is required.

CPS' operating procedures for the North and South Bottom Ash Ponds include methods of controlling the water levels in the ponds, but no formal documentation was provided to CDM Smith. There were no documented operating procedures for the Evaporation Pond.

1.3.2 Recommendations

Based on CDM Smith's visual assessment of North and South Bottom Ash Ponds and Evaporation Pond and review of documentation provided by CPS, CDM Smith offers the following recommendations for consideration.

1.3.2.1 Recommendations Regarding the Hydrologic/Hydraulic Safety

It is recommended that a qualified professional engineer determine the required IDF and evaluate the hydrologic and hydraulic capacity of the North and South Bottom Ash Ponds and Evaporation Pond to withstand design hydrologic/hydraulic events, without overtopping, as recommended by FEMA.

1.3.2.2 Recommendations Regarding the Technical Documentation for Structural Stability

None

1.3.2.3 Recommendations Regarding Field Observations

CDM Smith observed dense vegetation and trees up to 8 inches in diameter at the north embankment exterior slope of the North Bottom Ash Pond. CDM Smith recommends that trees and vegetation in the area be cut back and maintained to improve the ability to conduct a visual assessment of the slope. An area of erosion was observed in the north embankment crest of the North Bottom Ash Pond. To restore this area of erosion, it is recommended to place and compact structural fill to adjacent existing grade contours, and reseed or place armoring.

1.3.2.4 Recommendations Regarding Adequacy of Maintenance and Methods of Operation

It is recommended that vegetation on the Evaporation Pond embankments be maintained with seasonal mowing, as necessary, for animal control and surveillance and monitoring of embankments.

1.3.2.5 Recommendations Regarding Surveillance and Monitoring Program

The CPS surveillance, recording, and monitoring program for the North and South Bottom Ash Ponds, under the Texas Commission on Environmental Quality (TCEQ) for the National Pollutant Discharge Elimination System (NPDES) Permit appears to be adequate and complies with TCEQ requirements. Although the inspection program for the North and South Bottom Ash Ponds appears to be adequate, CDM Smith recommends that these inspections be documented in the future. It is recommended that CPS prepare formal surveillance and monitoring procedures for the Evaporation Pond.

1.3.2.6 Recommendations Regarding Continued Safe and Reliable Operation

Inspections should be made following periods of heavy and/or prolonged rainfall, and the occurrence of these events should be documented. Inspection procedures should be documented and inspection records should be retained at the facility for a minimum of three years. Major repairs and slope

restoration should be designed by a registered professional engineer experienced with earthen dam design.

The above recommendations should be implemented to help maintain continued safe and reliable operation of the CCW impoundments.

1.4 Participants and Acknowledgment

1.4.1 List of Participants

CDM Smith representatives, Jamal Daas, P.E. and Bevin Barringer, P.E, were accompanied at all times during visual assessment by Gregg Tieken, CPS Environmental Manager.

1.4.2 Acknowledgement and Signature

CDM Smith acknowledges that the CCW impoundments referenced herein were assessed by Jamal Daas, P.E. and Bevin Barringer, P.E. Based on the documentation provided, the North and South Bottom Ash Ponds and Evaporation Pond are rated SATISFACTORY. Minor deficiencies exist that require remedial measures.

We certify that the CCW impoundments referenced herein have been assessed on August 27 and 28, 2012.

Jamal Daas, P.E.
Geotechnical Engineer
Texas Registration No. 112062

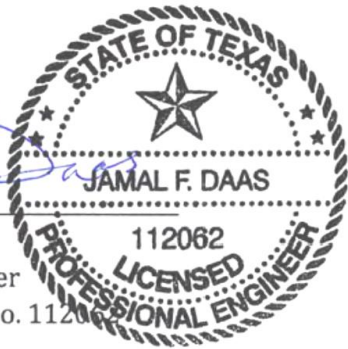

Bevin Barringer, P.E.
Geotechnical Engineer

Section 2

Description of the Coal Combustion Waste (CCW) Impoundment(s)

2.1 Location and General Description

The J.T. Deely Power Plant (Plant), owned by CPS Energy (CPS) is located in Bexar County at 12940 U.S. Highway 181 South, San Antonio, Texas (Latitude: 29° 18' 25.93" N, Longitude: 98° 19' 12.71" W), as shown on **Figure 2-1**. Critical infrastructure within approximately five miles down gradient of the Plant is shown on **Figure 2-2**. The Plant site is surrounded by open grassy areas with patches of trees, as shown on **Figure 2-3**. The Plant is surrounded by CPS-owned Calaveras Lake on the west, south, and east sides. Land to the north of the Plant property boundary is rural. The Plant site is shared with the J.K. Spruce Power Plant. Both Plants are owned by CPS.

The Plant has three Coal Combustion Waste (CCW) impoundments: the North Bottom Ash and South Bottom Ash Ponds just east of the Plant units and the Evaporation Pond approximately 1 mile northeast of the Plant units as shown on Figure 2-2. All three ponds were constructed as diked impoundments. The North and South Bottom Ash Ponds share a common embankment that separates the ponds and are located between the main Plant site and Calaveras Lake. The Evaporation Pond receives boiler chemical cleaning waste from CPS's J.T. Deely Power Plant and their J.K. Spruce Power Plant. Accordingly, the assessment of the Evaporation Pond is also included in a separate report prepared by CDM Smith for the J.K. Spruce Power Plant. The Evaporation Pond is located to the north of the CPS property in an undeveloped area surrounded by trees.

The Sludge Recycle Holding (SRH pond), also located at the site, is used to store CCW from the J.K. Spruce Power Plant. The SRH Pond is located west of the South Bottom Ash Pond. The SRH Pond and the South Bottom Ash Pond share a common embankment that includes spillways. The assessment of this impoundment is included in a separate report prepared by CDM Smith for the J.K. Spruce Power Plant. Other impoundments at the site that do not store CCW include the Coal Pile Runoff Pond used to store stormwater runoff from the coal storage area, #1 Stormwater Runoff Pond used to store stormwater runoff from the Plant site, and the 5-year Landfill Runoff Pond used to store runoff from the fly ash disposal landfill and Class I landfill. The #1 Stormwater Runoff and SRH Ponds are located west of the North and South Bottom Ash Pond and share common embankments. The layout of the ponds is shown on Figure 2-3.

The North Bottom Ash Pond has a total perimeter of approximately 2,100 feet and an approximate surface area of 6 acres. The South Bottom Ash Pond has a total perimeter of approximately 2,100 feet and an approximate surface area of 7 acres. The Evaporation Pond has a total perimeter of approximately 1,800 feet and has an approximate surface area of 4.5 acres. **Table 2-1** shows a summary of the approximate size and dimensions of the impoundments.

Table 2-1 – Summary of Impoundments Approximate Dimension and Size

	Impoundment		
	North Bottom Ash Pond	South Bottom Ash Pond	Evaporation Pond
Dam Height (feet)	12	12	22
Average Crest Width (feet)	15	15	20
Length (feet)	2,100	2,100	1,800
Interior Slopes, H:V	2:1	2:1	3:1
Exterior Slopes, H:V	3:1	3:1	3:1

Note: All dimensions were obtained from construction drawings.

2.1.1 Horizontal and Vertical Datum

Project drawings provided by CPS to CDM Smith did not include reference to the horizontal datum used. Based on the coordinates shown on the drawings, the date of the drawings, and the datum in general use at the time, it is likely that the drawings were referenced to the North American Datum of 1983 (NAD 83). Elevations included on the drawings are referenced to mean sea level (MSL). Elevations noted herein are in feet and are referenced to the datum used for the project drawings, MSL, unless otherwise noted.

2.1.2 Site Geology

The J.T. Deely Electric Plant is located in southeastern Bexar County, Texas. Based on review of the USGS Topographic Map, natural ground surface elevations in the area of the Plant range from approximately El. 490 to El. 530 referenced to the North American Vertical Datum of 1988. According to the Quaternary Geologic Map of the Austin 4 x 6 Quadrangle published by the United States Geological Survey, the Plant is located on clayey sand and sandy clay decomposition residuum from the Quaternary and Tertiary Periods. These deposits consist of gray, light brown, brown, or orange clayey, fine to medium quartz sand to fine sandy silty clay with subrounded sandstone pebbles, colluviums, and small bedrock outcrops in some localized areas. According to the United States Department of Agriculture, surface soils in the area are comprised of fine sand, loamy fine sand, and sandy clay loam.

Soil boring information was provided in a report prepared by Raba Kistner Consultants, Inc. (RKCI) dated May 7, 2014. In the RKCI report, the embankment fill is described as sandy clay and clayey sand. The subgrade stratigraphy includes sandy clay and clayey sand with isolated tan and gray clay seams. The 2014 RKCI report is included in **Appendix A**.

2.2 Coal Combustion Residue Handling

The North Bottom Ash Pond receives sluiced bottom ash from Deely Units 1 & 2. The pond also receives other low-volume waste and metal cleaning waste. Ash is excavated from the pond and sold for beneficial use approximately twice a year. Boiler slag is mixed with the bottom ash and recycled. The South Bottom Ash Pond receives sluiced bottom ash from Deely Units 1 & 2. The pond also receives low-volume waste and metal cleaning waste. Approximately twice a year, ash is excavated from the pond and sold for beneficial use. During the assessment, the South Bottom Ash Pond was drained and less than half of the pond contained ash material.

The Evaporation Pond receives boiler chemical cleaning waste that is trucked to the pond. The Evaporation Pond was constructed on top of a fly ash landfill that was converted into an ash impoundment in 1996. The ash landfill and impoundment were used to store ash materials at some time in the past but no further documentation was provided regarding the nature or amount of ash materials stored. Because it is unknown if the underlying pond was used to store CCW, a full assessment was performed on the Evaporation Pond. A geotechnical engineering study, performed by Raba Kistner Consultants, Inc., dated May 2014, included four borings through the Evaporation Pond embankments and into the underlying soils. As per the investigation's boring logs, soils underlying the embankment consisted of medium dense to very dense clayey sand. It does not appear the Deely CCW impoundments were constructed over wet ash, slag, or other unsuitable materials.

CPS has indicated that the Plant does not produce flue gas desulphurization gypsum.

2.3 Size and Hazard Classification

According to the United States Army Corps of Engineers (USACE) Guidelines for Safety Inspection of Dams (1979) (ER 1110-2-106), dams are categorized per **Table 2-2**.

Table 2-2 – USACE ER 1110-2-106 Size Classification

Category	Impoundment	
	Impoundment Storage Capacity (acre-feet)	Embankment Height (feet)
Small	50 to < 1000	25 to < 40
Intermediate	1000 to < 50,000	40 to < 100
Large	> 50,000	> 100

The total storage capacity of the North Bottom Ash Pond, South Bottom Ash Pond, and Evaporation Pond is approximately 72, 84, and 99 acre-feet, respectively. Therefore, the embankments for all three impoundments are classified as small dams as defined in ER 1110-2-106. The impoundment capacities were estimated by CDM Smith based on the geometry shown on the original construction drawings provided by CPS.

It is not known if the Plant impoundments currently have an assigned Hazard Potential Classification. Based on the USEPA classification system as presented on Page 2 of the USEPA checklist (**Appendix B**) and CDM Smith's review of the site and downstream areas, recommended hazard ratings have been assigned to the impoundments as summarized in **Table 2-3**:

Table 2-3 – Recommended Impoundment Hazard Classification Ratings

Ash Pond Unit	Recommended Hazard Rating	Basis
North Bottom Ash Pond	Significant Hazard	<ul style="list-style-type: none"> ▪ Failure or miss-operation would result in flow toward the main plant facilities resulting in damage to plant infrastructure, operations, and utilities. ▪ Loss of human life is not anticipated.
South Bottom Ash Pond	Significant Hazard	<ul style="list-style-type: none"> ▪ Failure or miss-operation would result in flow toward the main plant facilities resulting in damage to plant infrastructure, operations, and utilities. ▪ Loss of human life is not anticipated.

Table 2-3 – Recommended Impoundment Hazard Classification Ratings (Continued)

Ash Pond Unit	Recommended Hazard Rating	Basis
Evaporation Pond	Low Hazard	<ul style="list-style-type: none"> ▪ Failure or miss-operation would result in low economic and/or environmental losses. ▪ Losses would be limited to the owner’s property ▪ Loss of human life is not anticipated.

2.4 Amount and Type of Residuals Currently Contained in the Unit(s) and Maximum Capacity

According to CPS representatives, accumulated bottom ash in the North and South Bottom Ash Ponds is removed twice a year and sold for beneficial use. The surface area of the North Bottom Ash Pond is approximately 6 acres, and liquids from the pond are returned to the Plant or discharged to Calaveras Lake. The surface area of the South Bottom Ash Pond is approximately 7 acres, and during normal operation liquids from the pond are returned to the Plant or discharged to Calaveras Lake. During the site assessment, the South Bottom Ash Pond was drained and less than half of its storage volume contained bottom ash material.

CPS did not have any information on the amount or types of CCW that may have been stored beneath the existing Evaporation Pond. The Evaporation Pond is approximately 4.5 acres, nearly full of solids, and is used to store and dewater, through evaporation, boiler chemical cleaning waste that is trucked to the pond.

2.5 Principal Project Structures

Principal structures of the North Ash Pond include the following:

- Two 12-inch-diameter, and one 8-inch-diameter welded steel inlet pipes discharging sluiced ash near the center of the pond;
- One 24-inch-diameter welded steel outlet pipe at the interior slope near the southwest corner that returns liquids from the pond to the Plant;
- An outlet structure near the interior slope at the northeast corner consisting of a 12-inch-diameter welded steel vertical pipe with riser at El. 499 and a 12-inch-diameter welded steel drain pipe with invert El. 489. The outlet pipes are partially surrounded by a steel sheet pile wall containing an opening, with a floating sorbent boom, for flow to the outlet pipes. Both pipes at the outlet structure discharge liquids to an outfall at Calaveras Lake; and
- Earthen perimeter embankments composed of sandy clay and clayey sand fill.

Principal structures of the South Ash Pond include the following:

- Two 12-inch-diameter, and one 8-inch-diameter welded steel inlet pipes discharging sluiced ash near the center of the pond;
- One 24-inch-diameter welded steel outlet pipe at the interior slope near the northwest corner that returns liquids from the pond to the Plant;

- An outlet structure near the interior slope at the southeast corner consisting of a 12-inch-diameter welded steel vertical pipe with riser at El. 499 and a 12-inch-diameter welded steel drain pipe with invert El. 489. The outlet pipes are partially surrounded by a steel sheet pile wall containing an opening, with a floating sorbent boom, for flow to the outlet pipes. Both pipes at the outlet structure discharge liquids to an outfall at Calaveras Lake; and
- Earthen perimeter embankments composed of sandy clay and clayey sand fill.

Principal structures of the Evaporation Pond include the following:

- Earthen perimeter embankments composed of sandy clay and clayey sand fill.

2.6 Critical Infrastructure within Five Miles Downgradient

Based on available topographic maps, surface drainage in the vicinity of the Plant appears to be toward Calaveras Lake. Critical infrastructure within five miles downgradient of the impoundments includes the Town of Elmendorf, TX, located just south of Calaveras Lake and approximately 3.5 miles south of the Plant. The only known infrastructure within 5 miles down gradient of the Plant included places of worship, as shown on Figure 2-1. However discharge at any of the impoundments would ultimately be contained in Calaveras Lake, due to its large size covering approximately 3,000 acres.

Due to its shared embankments with the SRH and #1 Stormwater Runoff Pond, failure or misoperation of the North and South Bottom Ash Ponds could result in discharge into the adjacent impoundments. Subsequent failure of the adjacent impoundments would likely result in flow toward the Plant facilities and would result in damage to plant infrastructure, operations, and utilities. Loss of human life is not anticipated. A breach of the impoundment embankments would most likely impact Plant property and Calaveras Lake.

Because of its relatively remote location, failure or misoperation of the Evaporation Pond would likely result in discharge to the surrounding wooded area and eventually flow into Calaveras Lake.

PW:\PW_XM1\Documents\51119193083_Deely\03 Reports and Studies\09 CADD Figures and Graphics\B001\VMFG.DWG
© 2012 CDM SMITH ALL RIGHTS RESERVED. REUSE OF DOCUMENTS, THESE DOCUMENTS AND DESIGNS PROVIDED BY PROFESSIONAL SERVICE, INCORPORATED HEREIN, ARE THE PROPERTY OF CDM SMITH
AND ARE NOT TO BE USED, IN WHOLE OR PART, FOR ANY OTHER PROJECT WITHOUT THE WRITTEN AUTHORIZATION OF CDM SMITH.
© 2012 CDM Smith / GTS-GEOTECHNICAL & TUNNELING SERVICES DIVISION

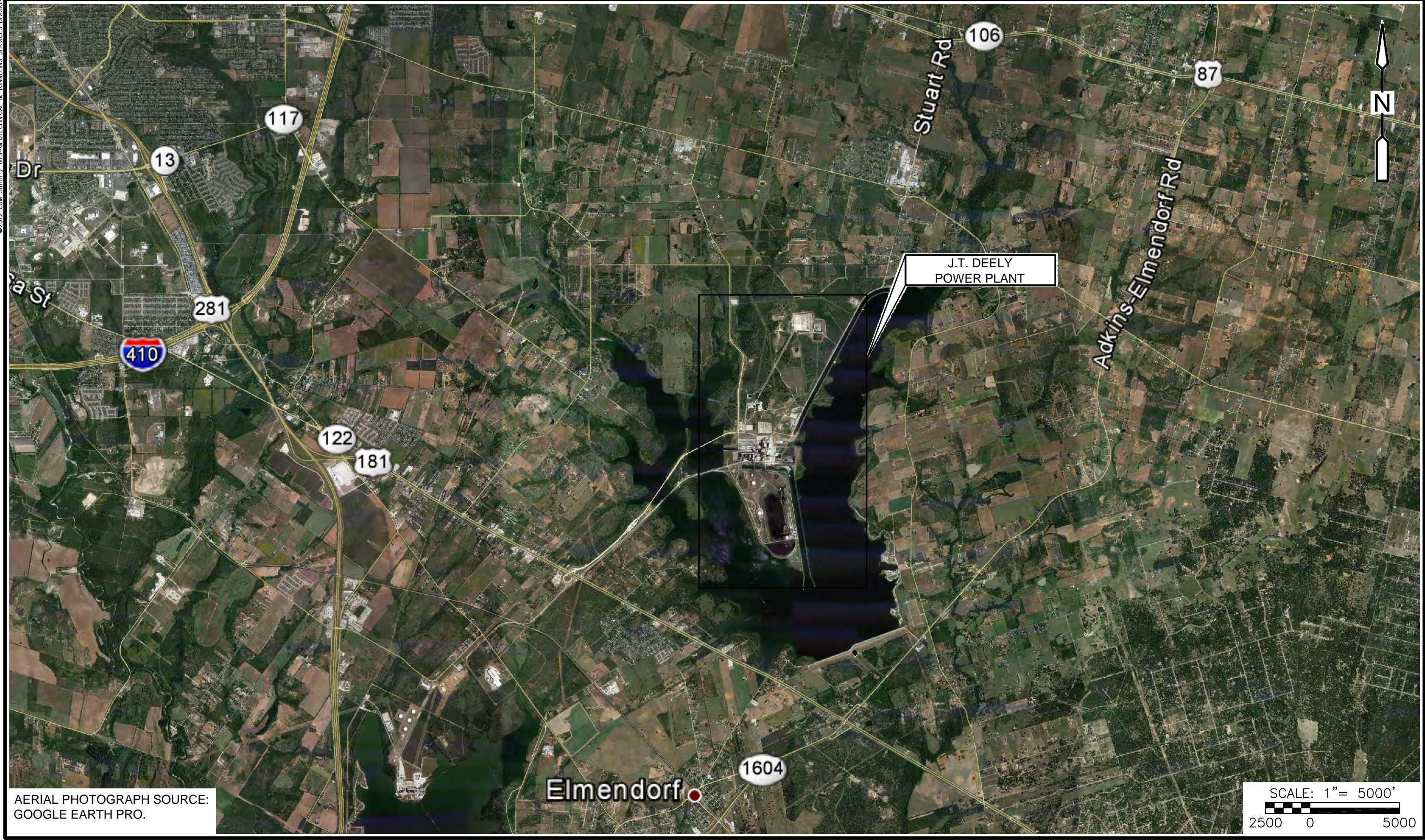

AERIAL PHOTOGRAPH SOURCE:
GOOGLE EARTH PRO.



J.T. DEELY POWER PLANT
SAN ANTONIO, TEXAS
VICINITY MAP
FIGURE 2-1

PW:\IPW_XM1\Documents\51119193083_Deely\03 Reports and Studies\09 CADD Figures and Graphics\B002C\FG.DWG
© 2012 CDM SMITH ALL RIGHTS RESERVED. REUSE OF DOCUMENTS: THESE DOCUMENTS AND DESIGNS PROVIDED BY PROFESSIONAL SERVICE, INCORPORATED HEREIN, ARE THE PROPERTY OF CDM SMITH
AND ARE NOT TO BE USED, IN WHOLE OR PART, FOR ANY OTHER PROJECT WITHOUT THE WRITTEN AUTHORIZATION OF CDM SMITH.

© 2012 CDM Smith / GTS-GEOTECHNICAL & TUNNELING SERVICES DIVISION



AERIAL PHOTOGRAPH SOURCE:
GOOGLE EARTH PRO.



J.T. DEELY POWER STATION
SAN ANTONIO, TEXAS
CRITICAL INFRASTRUCTURE PLAN
FIGURE 2-2

PW:\PW_XM1\Documents\51119\93083_Deely\03 Reports and Studies\09 CADD Figures and Graphics\B003SPFG.dwg
© 2012 CDM SMITH ALL RIGHTS RESERVED. REUSE OF DOCUMENTS: THESE DOCUMENTS AND DESIGNS PROVIDED BY PROFESSIONAL SERVICE, INCORPORATED HEREIN, ARE THE PROPERTY OF CDM SMITH AND ARE NOT TO BE USED, IN WHOLE OR PART, FOR ANY OTHER PROJECT WITHOUT THE WRITTEN AUTHORIZATION OF CDM SMITH.

© 2012 CDM Smith / GTS-GEOTECHNICAL & TUNNELING SERVICES DIVISION

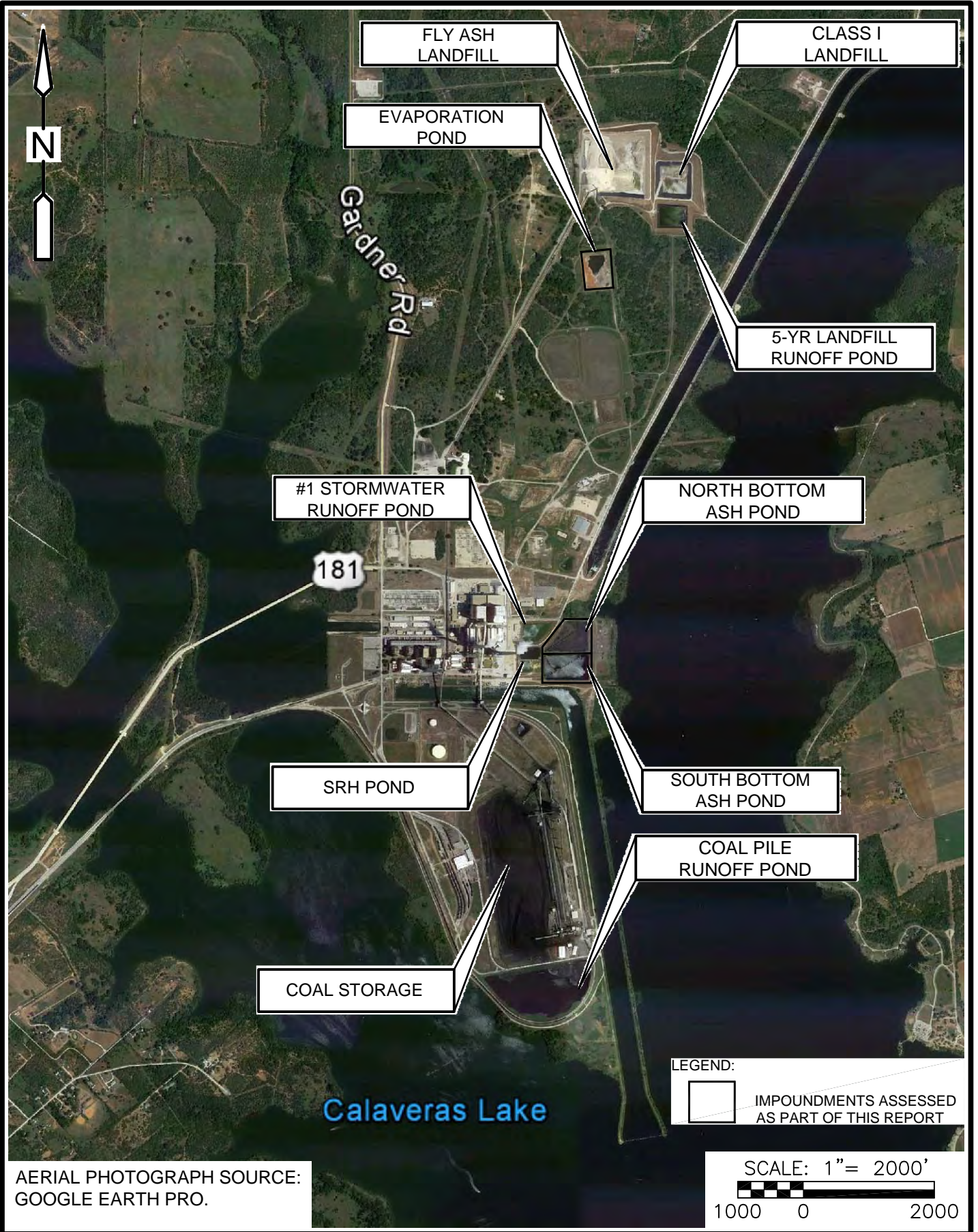

J.T. DEELY POWER PLANT
SAN ANTONIO, TEXAS
SITE PLAN
FIGURE 2-3

Section 3

Summary of Relevant Reports, Permits and Incidents

3.1 Summary of Reports on the Safety of the CCW Impoundments

Safety reports for the CCW impoundments were not available for CDM Smith's review during the course of this investigation. CPS indicated that to their knowledge no formal inspections of the impoundments have been performed and no safety reports prepared.

CPS representatives indicated to their knowledge there have been no known structural or operational problems associated with the CCW impoundments.

3.2 Summary of Local, State, and Federal Environment Permits

Currently, the CCW impoundments are regulated by the Texas Commission on Environmental Quality (TCEQ).

The J.T. Deely Power Plant was issued a permit by TCEQ under the National Pollutant Discharge Elimination System (NPDES) which includes outfalls for the North and South Bottom Ash Ponds. The Plant discharges liquids from the North and South Bottom Ash Ponds into Calaveras Lake under this permit. The permit, WQ0001514000, was issued on October 18, 2011 and expires on March 1, 2015. Because the Evaporation Pond does not include outlet structures, it is not included in the NPDES permit.

3.3 Summary of Spill/Release Incidents

According to CPS representatives, no releases or spills have occurred at the North and South Bottom Ash Ponds and Evaporation Pond.

Section 4

Summary of History of Construction and Operation

4.1 Summary of Construction History

4.1.1 Impoundment Construction and Historical Information

The J.T. Deely Power Plant began operation in 1977. The Plant has two coal-fired units and generates electricity with a total capacity of 800 megawatts of power.

The North and South Bottom Ash Ponds were constructed in 1977. Historical information on the North and South Bottom Ash Ponds available for review included original construction drawings provided in **Appendix C**. The North and South Bottom Ash Ponds were constructed approximately 300 feet west of Calaveras Lake, and 100 feet north of the Plant intake canal. Construction drawings show that the North and South Bottom Ash Ponds include perimeter embankments with approximately 11-foot-high, 15-foot-wide crests, with interior side slopes at 2 horizontal to 1 vertical (2H:1V) and exterior side slopes at 3H:1V. Crests were constructed to El. 500 and the bottom of the pond to El. 489. Construction documents appear to indicate the embankments were constructed with on-site excavated material however the location for the source of the embankment fill is unknown. No historical subsurface soil information in the vicinity of the North and South Bottom Ash Ponds was provided. Boring logs included in the 2014 RKC report indicate the embankments consist of sandy clay and clayey sand fill material, and underlying native material consists of sandy clay and clayey sand with isolated tan and gray clay seams. Based on review of construction drawings, the North and South Bottom Ash Ponds are unlined.

The Evaporation Pond was constructed on top of an area that was previously used as a fly ash landfill and fly ash impoundment. Based on information provided by CPS the embankments were originally constructed sometime in the past for use as a fly ash landfill. No documentation on the original construction of the fly ash landfill was provided. In 1996 the landfill was converted into a fly ash impoundment. Construction drawings dated 1990 show the existing embankments with a crest elevation at El. 522 and bottom of the impoundment at El. 500. These construction drawings are included in Appendix C. The exterior and interior slopes are shown at 3H:1V. The crest is shown as 6 feet wide at the south embankment, 20 feet wide at the west and east embankments, and 30 feet wide at the north embankment. The 1990 construction drawings show that a 30-mil PVC liner was added to the interior slopes of the embankments. The function of the fly ash impoundment changed from storing fly ash to dewatering boiler chemical cleaning waste at some time after 1996.

4.1.2 Significant Changes/Modifications in Design since Original Construction

According to CPS representatives, significant modifications have been made to the North and South Bottom Ash embankments over the years, include adding ash and other granular material to the crest to maintain the roadway and widening the north embankment crest of the North Bottom Ash Pond. Based on survey drawings, it appears that the crests have been brought up about one foot on the North and South Bottom Ash Pond embankments. The embankment crests are currently at approximately El. 501. The north embankment of the bottom ash pond was originally constructed 15 feet wide based on construction drawings, but measured approximately 30 feet wide during the site assessment. No documentation of these modifications was provided.

According to CPS representatives, the Evaporation Pond was originally constructed as a fly ash landfill, converted into a fly ash impoundment, and then used as an evaporation pond for boiler chemical cleaning wastes. No documentation on the original construction of the fly ash landfill was provided. The only changes/modifications documented include the addition of the PVC liner shown on the 1990 construction drawings. Based on the visual observations during the site assessment, it appears the current configuration of the Evaporation Pond is consistent with the 1990 drawings.

4.1.3 Significant Repairs/Rehabilitation since Original Construction

According to information provided by CPS no significant repairs or rehabilitation have been made to the North and South Bottom Ash Ponds, and Evaporation Pond.

4.2 Summary of Operational Procedures

4.2.1 Original Operating Procedures

The North Bottom Ash Pond has historically been used as a settling pond for sluiced bottom ash received from the Plant. Waste water streams discharged into the North Bottom Ash Pond have included:

- Bottom ash
- Low-volume waste
- Metal cleaning waste

The South Bottom Ash Pond has historically been used as a settling pond for sluiced bottom ash received from the Plant. Waste water streams discharged into the South Bottom Ash Pond have included:

- Bottom ash
- Low volume waste
- Metal cleaning waste

The fly ash impoundment underlying the Evaporation Pond had historically been used as a fly ash landfill and fly ash impoundment to store fly ash generated by the J.T. Deely and J.K. Spruce Power Plants. Recently the Evaporation Pond has been used to dewater, through evaporation, boiler chemical cleaning wastes. Waste stored in the Evaporation Pond has included:

- Fly ash
- Boiler chemical cleaning wastes

4.2.2 Significant Changes in Operational Procedures and Original Startup

No significant changes in operational procedures had been made to the North and South Bottom Ash Ponds. There was no documentation provided that indicates different.

The Evaporation Pond's function and operational procedures have changed over the years. The Evaporation Pond was constructed on top of a fly ash landfill that was converted into an ash impoundment in 1996. The ash landfill and impoundment were used to store ash materials at some

time in the past but no further documentation was provided regarding the nature or amount of ash materials stored. Because it is unknown if the underlying pond was used to store CCW, a full assessment was performed on the Evaporation Pond. Currently the impoundment only receives boiler chemical cleaning wastes that are transported to the pond by truck.

4.2.3 Current CCW Impoundment Configuration

The North and South Bottom Ash Ponds and Evaporation Pond are currently configured as previously described and as shown on Figure 2-3. The approximate crest elevations of the embankments and pond areas are shown in **Table 4-1** below.

Table 4-1 – Approximate Crest Elevations and Surface Areas

Ash Pond	Approximate Crest Elevation (Feet)	Approximate Pond Surface Area (Acres)
North Bottom Ash Pond	501	6
South Bottom Ash Pond	501	7
Evaporation Pond	522	4.5

Over the life of the impoundments, ash has been excavated from the North and South Bottom Ash Pond approximately twice a year. Ash from the North Bottom Ash Pond was last excavated in April 2012 and from the South Bottom Ash Pond in August 2012. The Evaporation Pond was previously used to store fly ash, and during the site assessment solids in the impoundment were up to 0.5 to 2 feet below the crest elevation.

Under normal operating conditions, liquids are discharged into the North and South Bottom Ash Ponds through several pipes discharging near the center of the ponds. Outlet structures include a vertical outlet pipe with invert elevation El. 499 that is open during normal operations and used to maintain the water level in the ponds. Each pond also includes a drain pipe with invert elevation El. 489, that is opened to drain the ponds for periodically excavating ash. Liquids from the ponds are discharged into Calaveras Lake through outfalls located at the Plant's intake canal just south of the ponds. The North and South Bottom Ash Ponds also each include an outlet that is generally closed during normal operations, but can return liquids from the ponds to the Plant.

Under normal operating conditions boiler chemical cleaning wastes are transported by truck to the Evaporation Pond. The cleaning wastes are stored in the pond and dewatered, through evaporation, and no liquids are discharged from the impoundment.

4.2.4 Other Notable Events since Original Startup

Based on furnished information, there are no other notable events since original startup of the North and South Bottom Ash Ponds and Evaporation Pond to report at this time.

Section 5

Field Observations

5.1 Project Overview and Significant Findings (Visual Observations)

CDM Smith performed visual assessments of the impoundments at the J.T. Deely site. Impoundments assessed included the North and South Bottom Ash Ponds and the Evaporation Pond. The Bottom Ash Ponds are located between the generating units and Calaveras Lake. The Evaporation Pond is located approximately 1 mile northeast of the generating units. The perimeter embankments of the North and South Bottom Ash Ponds are each approximately 2,100 feet long, including the 700-foot-long center embankment that separates the two ponds, and approximately 12 feet high. The perimeter embankments of the Evaporation Pond are approximately 1,800 feet long and approximately 22 feet high. The assessments were completed following the general procedures and considerations contained in Federal Emergency Management Agency's (FEMA's) Federal Guidelines for Dam Safety (April 2004) to make observations concerning settlement, movement, erosion, seepage, leakage, cracking, and deterioration. A Coal Combustion Dam Inspection Checklist and Coal Combustion Waste (CCW) Impoundment Inspection Form, developed by USEPA, were completed for each of the aforementioned impoundments. Copies of these forms are included in Appendix B. Photograph locations are shown on **Figures 5-1** through **5-4**, and photographs are included in **Appendix D**. Photograph locations were logged using a handheld GPS device. The photograph coordinates are listed in Appendix D.

CDM Smith visited the Plant on August 27 and 28, 2012, to conduct visual assessments of the impoundments. The weather was generally sunny with daytime high temperatures up to 100 degrees Fahrenheit. The daily total precipitation prior to the site visit is shown in **Table 5-1**. The data were obtained from the National Oceanic and Atmospheric Administration (NOAA) station at the San Antonio Stinson Municipal Airport, approximately 9 miles west of the Plant.

Table 5-1 – Approximate Precipitation Prior to Site Visit

Date of Site Visit – August 27 and 28, 2012		
Day	Date	Precipitation (inches)
Monday	August 26	0
Sunday	August 25	0
Saturday	August 24	0
Friday	August 23	0
Thursday	August 22	0
Wednesday	August 21	0
Tuesday	August 20	0
Monday	August 19	2.05
Total	(August 19 - 26, 2012)	2.05
Total	Month Prior to Site Visit (July 26 – August 26, 2012)	2.38

Note: Precipitation data from NOAA. Station Location: San Antonio Stinson Municipal Airport. Lat. 28.3389; Lon. -98.472; EL.571 feet.

5.2 North Bottom Ash Pond

At the time of the assessment, the North Bottom Ash Pond contained bottom ash and liquids with approximately 2 feet of freeboard. An overview of the photographs taken at the North Bottom Ash Pond during the CDM Smith site assessment is included on Figure 5-1. Photographs of the pond outfalls are included on Figure 5-3.

5.2.1 Crest

The crest of the North Bottom Ash Pond appeared to be in satisfactory condition (Photographs 1, 10, 29, and 42). The crest was approximately 15 feet wide at all embankments except the north embankment where the crest measured approximately 30 feet wide. The crest of the embankments consists of compacted granular soils and gravel and is exposed to minimal vehicle traffic. An area of erosion near a fence post was observed at the north embankment crest (Photographs 5 and 52). Wood support poles for overhead powerlines are located in the crest of the north embankment (Photograph 1). No depressions or evidence of settlement were observed on the crest.

5.2.2 Interior Slopes

Due to the water level in the North Bottom Ash Pond during the assessment, only the upper 2 feet of the interior slopes were visible (Photographs 3, 12, 27, and 40). Based on construction drawings, the interior slopes were constructed at 2H:1V. The interior slopes were measured at approximately 3H:1V near the top of the embankment and included a layer of ash material (Photograph 28). Small areas of erosion into ash were observed on the interior slope at the east, south, and west embankments (Photographs 17, 23, 38, and 43) and an area of loose ash was observed on the east embankment interior slope (Photograph 14). Vegetation covered some portions of the interior slopes that were visible (Photographs 6, 12, 32, and 35). Visible portions of interior slopes did not include riprap or other armoring.

5.2.3 Exterior Slopes

Exterior slopes of the North Bottom Ash Pond appear to be in fair condition (Photographs 15, 30, 39, and 49). Due to the terrain and vegetation on the exterior slope of the north embankment, the slope was only visible from the embankment crest (Photograph 50). A few small trees and brush less than 8 inches in diameter were observed on the exterior slope of the north embankment (Photographs 47 and 48). The exterior slopes of the west and east embankments are approximately 3H:1V and covered in grassy vegetation approximately 3 inches tall (Photographs 16 and 39). The south embankment is shared with the South Bottom Ash Pond and is covered in ash material with sparse vegetation consisting primarily of grass and brush, approximately 2 feet high. Some areas of minor erosion into the ash material (Photographs 24, 25, and 26) were observed. The #1 Stormwater Runoff Pond is located at the west embankment exterior toe and the SRH Pond is located at the exterior toe of the southwest corner (Photograph 37).

5.2.4 Inlet Piping

Three inlet pipes discharge liquids near the center of the North Bottom Ash Pond; two 12-inch-diameter welded steel and one 8-inch-diameter welded steel pipe (Photographs 18 and 33).

5.2.5 Outlet Structures

The outlet structure located near the interior slope of the northeast corner consists of a 12-inch-diameter welded steel vertical outlet pipe and a 12-inch-diameter welded steel drain pipe. The outlet pipes are partially surrounded by a steel sheet pile wall containing an opening, with a floating sorbent boom (Photographs 7 and 11). The outlet pipes discharge liquids from the North Bottom Ash Pond to outfalls at the Plant intake canal (Photographs 85, 86, 87, and 88). A 24-inch-diameter welded steel outlet pipe at the interior slope near the southwest corner returns liquids from the pond to the Plant (Photograph 34).

5.3 South Bottom Ash Pond

At the time of the assessment, the South Bottom Ash Pond was drained. CCW had been recently excavated from the pond, leaving approximately 9 feet of freeboard. An overview of the photographs taken at the South Bottom Ash Pond during the CDM Smith site assessment is included on Figure 5-2. Photographs of the pond outfalls are included on Figure 5-3.

5.3.1 Crest

The crest of the South Bottom Ash Pond appeared to be in satisfactory condition (Photographs 29, 56, 65, and 73). All embankment crests were approximately 15 feet wide and consists of compacted granular soils and gravel and is exposed to minimal vehicle traffic. A clarifier structure associated with the adjacent SRH Pond was located on the west embankment crest (Photograph 78). The west embankment crest included two spillways connecting the SRH and South Bottom Ash Ponds (Photographs 75, 76, 77, 79, 80, and 81). No depressions or evidence of settlement were observed on the crest.

5.3.2 Interior Slopes

Interior slopes appeared to be in fair condition (Photographs 30, 59, 66, and 70). Based on construction drawings, the interior slopes were constructed at 2H:1V. The north embankment is shared with the North Bottom Ash Pond and is covered in ash material (Photograph 22). Vegetation is sparse, consisting primarily of grass and brush, approximately 2 feet high (Photographs 24, 25, 26, 59, 64, 70, and 84). Some areas of minor erosion into the ash material (Photographs 24, 25, and 26) were observed. A stockpile of CCW was observed on the east embankment interior slope (Photograph 57). Visible portions of interior slopes were not protected by riprap or other armoring.

5.3.3 Exterior Slopes

Exterior slopes of the South Bottom Ash Pond appear to be in fair condition (Photographs 27, 58, 62, and 74). The exterior slopes of the east and south embankments are approximately 3H:1V and covered in grassy vegetation approximately 3 inches tall (Photograph 63). The north embankment exterior slope is shared with the North Bottom Ash Pond and is covered in ash material with sparse vegetation consisting of grass and brush, approximately 2 feet high. Some areas of minor erosion were observed on the exterior slope, in the ash material (Photograph 23). The SRH Pond is located at the west embankment exterior slope and is covered with ash and other granular material (Photographs 74, 81, and 82). A drainage ditch is located at the south embankment exterior toe (Photograph 67).

5.3.4 Inlet Piping

Three inlet pipes discharge liquids near the center of the South Bottom Ash Pond; two 12-inch-diameter welded steel and one 8-inch-diameter welded steel pipe (Photograph 71). The piping was being replaced during the site assessment (Photograph 68).

5.3.5 Outlet Structures

The outlet structure near the interior slope of at the southeast corner consists of a 12-inch-diameter welded steel vertical outlet pipe and a 12-inch-diameter steel drain pipe. The outlet pipes are partially surrounded by a steel sheet pile wall containing an opening, with a floating sorbent boom, for flow to the outlet pipes (Photograph 61). The outlet pipes discharge liquids from the South Bottom Ash Pond to outfalls at the Plant intake canal (Photographs 85, 86, 87, and 89). A 24-inch-diameter welded steel outlet pipe at the interior slope near the northwest corner returns liquids from the pond to the Plant (Photograph 83).

5.4 Evaporation Pond

At the time of the assessment, the Evaporation Pond contained solids and boiler chemical cleaning wastes that were being dewatered in the impoundment with approximately 2 feet of freeboard. An overview of the photographs taken at the Evaporation Pond during the CDM Smith site assessment is included in Figure 5-4.

5.4.1 Crest

The embankment crest of the Evaporation Pond appeared to be in satisfactory condition (Photographs 90, 100, 108, and 114). The crest was approximately 15 feet wide at all embankments except the north embankment where the crest measured approximately 50 feet wide. The crest of the embankment consists of a compacted gravel drive and grass. The surface is exposed to minimal vehicle traffic. No depressions or evidence of settlement were observed on the crest.

5.4.2 Interior Slopes

Due to the level of solids and water in the Evaporation Pond during the assessment, only the upper 0.5 to 2 feet of the interior slopes were visible (Photographs 91, 101, 102, 106, and 115). Vegetation covered some portions of the west and south embankment interior slopes (Photographs 111, 115, and 120). Ash and other solid material extend up to the crest near the southeast corner interior slope and on the east embankment interior slope (Photographs 91 and 122). Visible portions of interior slopes did not include riprap or other armoring.

5.4.3 Exterior Slopes

The exterior slopes appear to be in satisfactory condition and are covered in grassy vegetation approximately 2 feet high and a few small trees and bushes with diameters less than 6 inches in diameter (Photographs 93, 98, 109, and 119). Areas of loose soil were observed at the east embankment exterior slope (Photographs 92, 94, and 96) and an animal burrow was observed in the west embankment exterior slope (Photograph 110). An area of exposed soil was observed at the south embankment exterior slope (Photograph 117). Based on construction drawings, the exterior slopes are 3H:1V at all embankments, though slopes measured in the field ranged from 3H:1V to 4H:1V (Photographs 97 and 118). Trees up to 12 inches in diameter were located at the toe of all embankments (Photographs 95, 105, 112, and 119).

PW:\PW_XM1\Documents\51119\93083_Deely\03 Reports and Studies\09 CADD Figures and Graphics\B004PHFG.DWG
© 2012 CDM SMITH ALL RIGHTS RESERVED. REUSE OF DOCUMENTS, THESE DOCUMENTS AND DESIGNS PROVIDED BY PROFESSIONAL SERVICE, INCORPORATED HEREIN, ARE THE PROPERTY OF CDM SMITH AND ARE NOT TO BE USED, IN WHOLE OR PART, FOR ANY OTHER PROJECT WITHOUT THE WRITTEN AUTHORIZATION OF CDM SMITH.
© 2012 CDM Smith / GIS-GEOTECHNICAL & TUNNELING SERVICES DIVISION

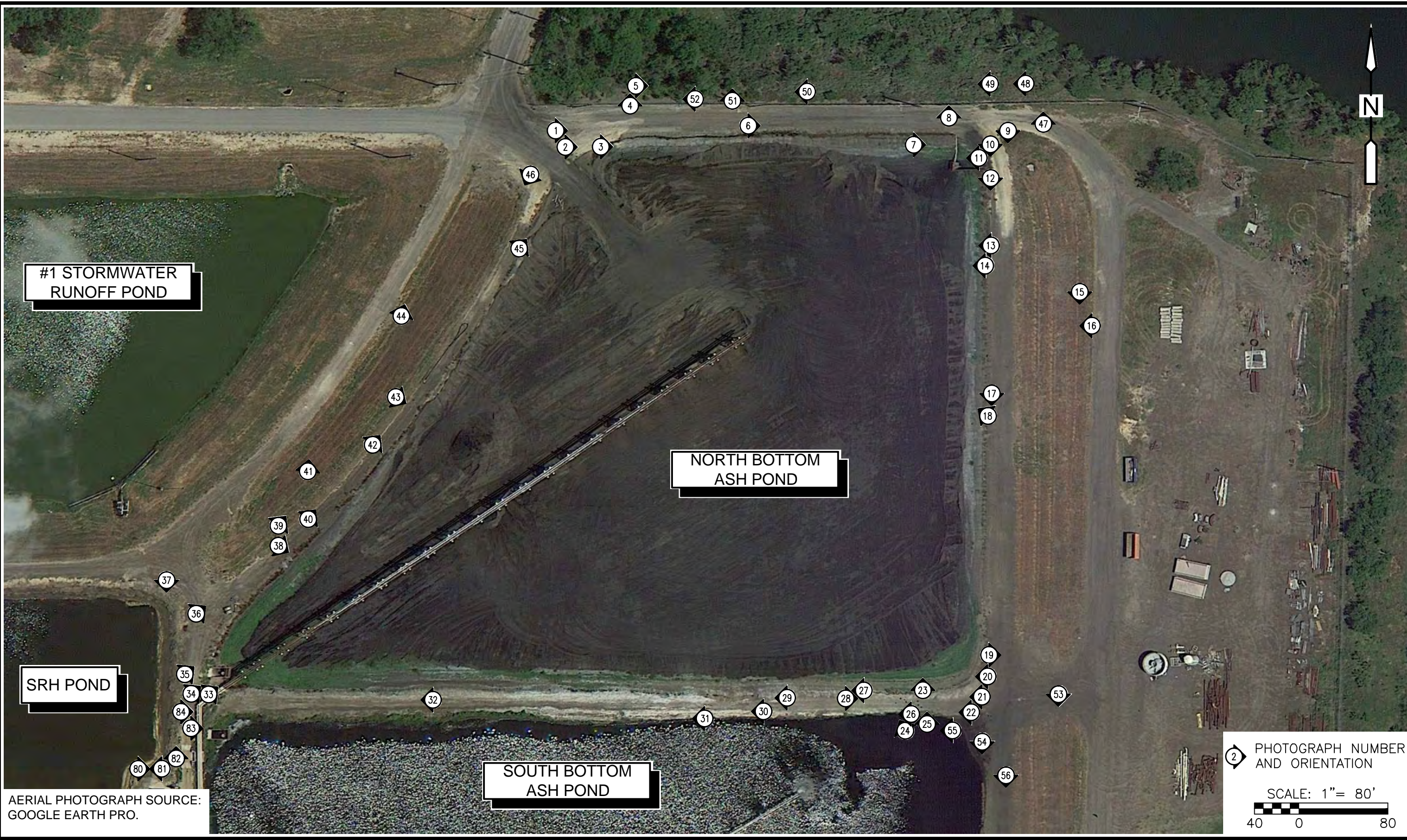

#1 STORMWATER RUNOFF POND

NORTH BOTTOM ASH POND

SRH POND

SOUTH BOTTOM ASH POND

AERIAL PHOTOGRAPH SOURCE:
GOOGLE EARTH PRO.

2 PHOTOGRAPH NUMBER AND ORIENTATION

SCALE: 1" = 80'
40 0 80



J.T. DEELY POWER PLANT
SAN ANTONIO, TEXAS
NORTH BOTTOM ASH POND
FIGURE 5-1

PW:\PW_XM1\Documents\51119\93083_Deely\03 Reports and Studies\09 CADD Figures and Graphics\B005PHFG.DWG
© 2012 CDM SMITH ALL RIGHTS RESERVED. REUSE OF DOCUMENTS, THESE DOCUMENTS AND DESIGNS PROVIDED BY PROFESSIONAL SERVICE, INCORPORATED HEREIN, ARE THE PROPERTY OF CDM SMITH
AND ARE NOT TO BE USED, IN WHOLE OR PART, FOR ANY OTHER PROJECT WITHOUT THE WRITTEN AUTHORIZATION OF CDM SMITH.
© 2012 CDM Smith / GIS-GEOTECHNICAL & TUNNELING SERVICES DIVISION

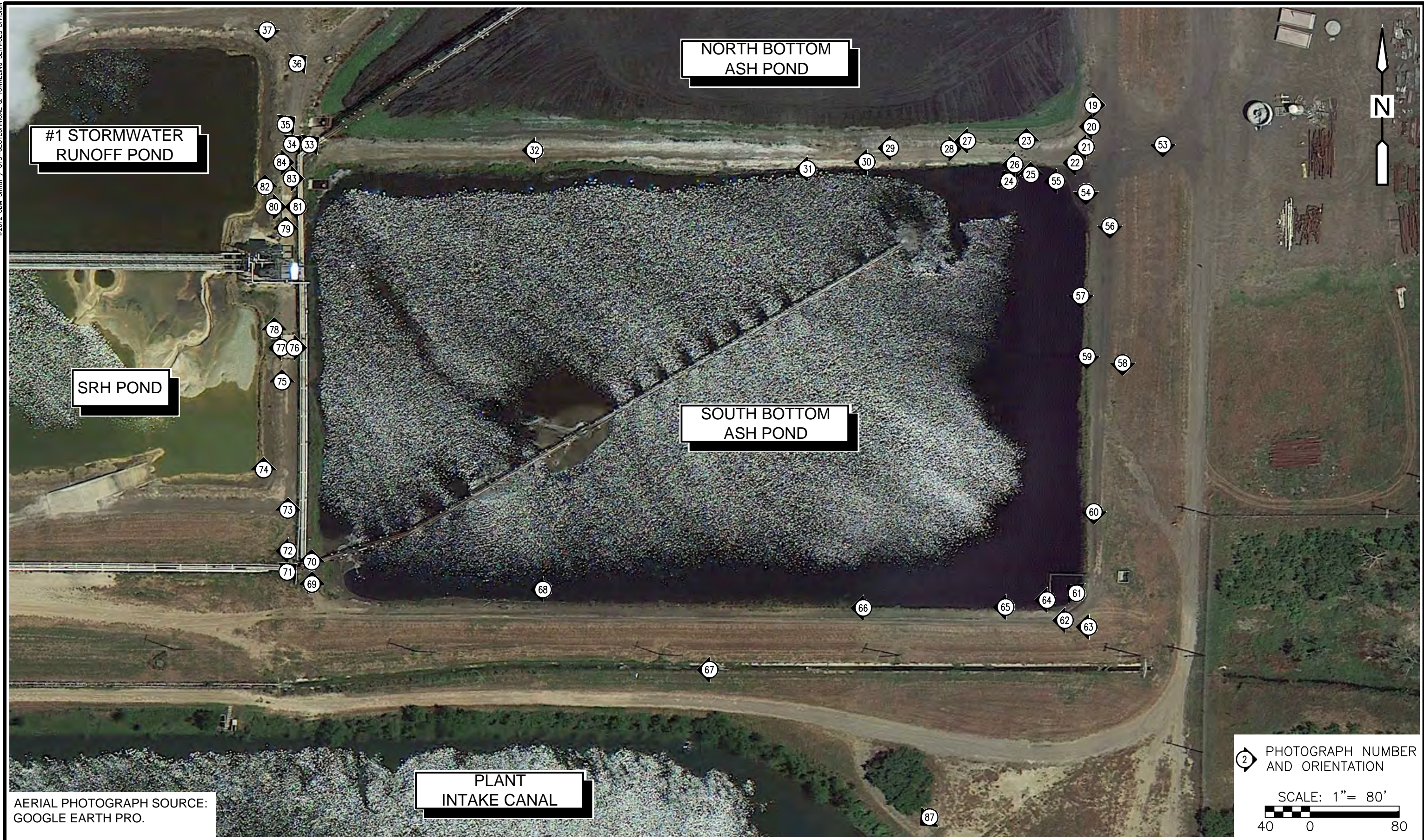

AERIAL PHOTOGRAPH SOURCE:
GOOGLE EARTH PRO.

② PHOTOGRAPH NUMBER
AND ORIENTATION

SCALE: 1" = 80'

40 0 80



J.T. DEELY POWER PLANT
SAN ANTONIO, TEXAS
SOUTH BOTTOM ASH POND
FIGURE 5-2

PW:\PW_XM1\Documents\51119\93083_Deely\03 Reports and Studies\09 CADD Figures and Graphics\B006PHFG.DWG
© 2012 CDM SMITH ALL RIGHTS RESERVED.
REUSE OF DOCUMENTS: THESE DOCUMENTS AND DESIGNS PROVIDED BY PROFESSIONAL SERVICE, INCORPORATED HEREIN, ARE THE PROPERTY OF
CDM SMITH AND ARE NOT TO BE USED, IN WHOLE OR PART, FOR ANY OTHER PROJECT WITHOUT THE WRITTEN AUTHORIZATION OF CDM SMITH.
© 2012 CDM Smith / GIS-GEO TECHNICAL & TUNNELING SERVICES DIVISION

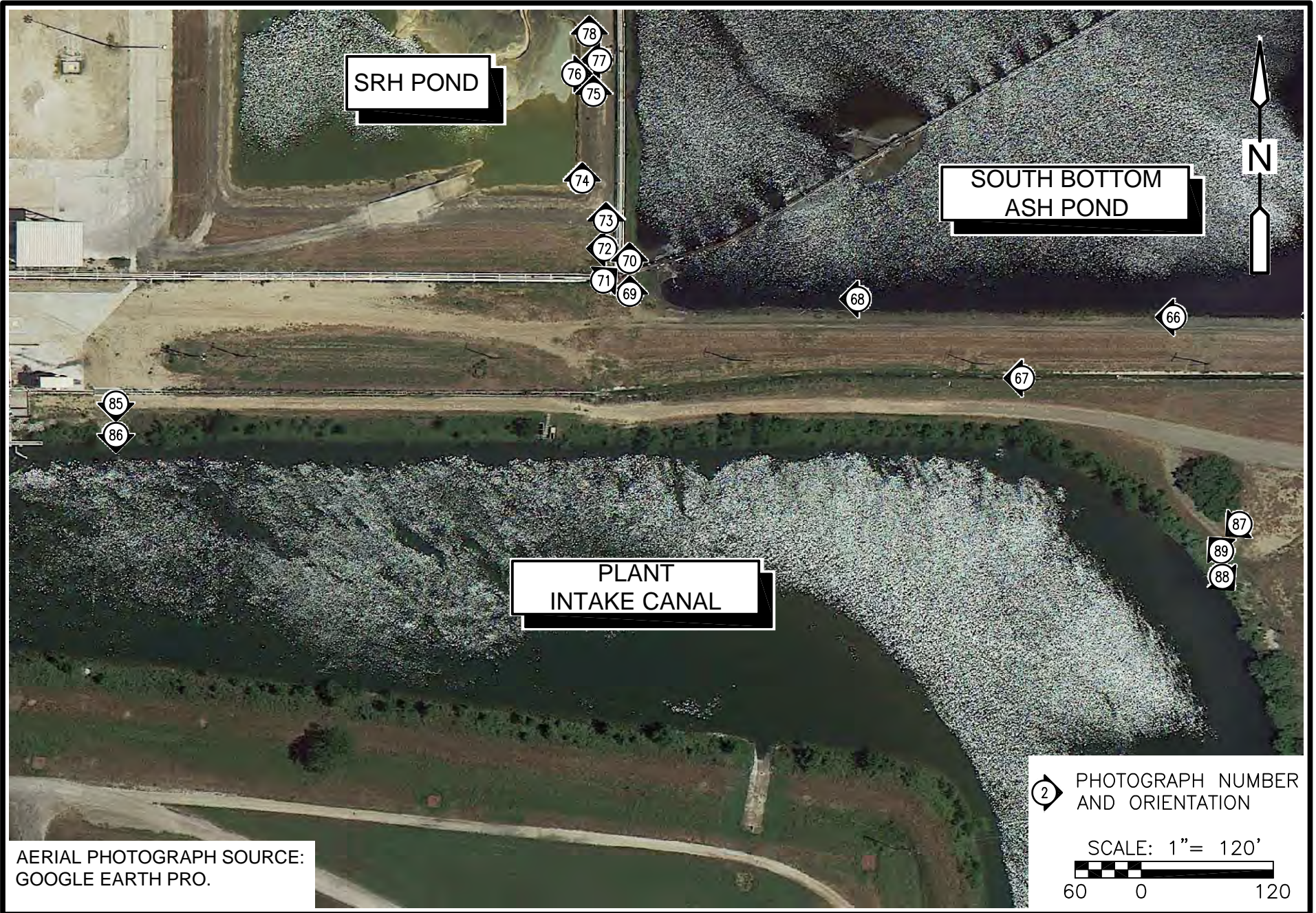

AERIAL PHOTOGRAPH SOURCE:
GOOGLE EARTH PRO.

② PHOTOGRAPH NUMBER
AND ORIENTATION

SCALE: 1" = 120'

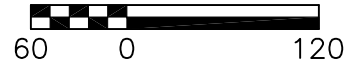

**CDM
Smith**

J.T. DEELY POWER PLANT
SAN ANTONIO, TEXAS
ASH POND OUTFALLS
FIGURE 5-3

PW:\PW_XM1\Documents\5119\93083_Deely\03 Reports and Studies\09 CADD Figures and Graphics\B007PHFG.DWG
© 2012 CDM SMITH ALL RIGHTS RESERVED. REUSE OF DOCUMENTS: THESE DOCUMENTS AND DESIGNS PROVIDED BY PROFESSIONAL SERVICE, INCORPORATED HEREIN, ARE THE PROPERTY OF CDM SMITH
AND ARE NOT TO BE USED, IN WHOLE OR PART, FOR ANY OTHER PROJECT WITHOUT THE WRITTEN AUTHORIZATION OF CDM SMITH.
© 2012 CDM Smith / GTS-GEOTECHNICAL & TUNNELING SERVICES DIVISION

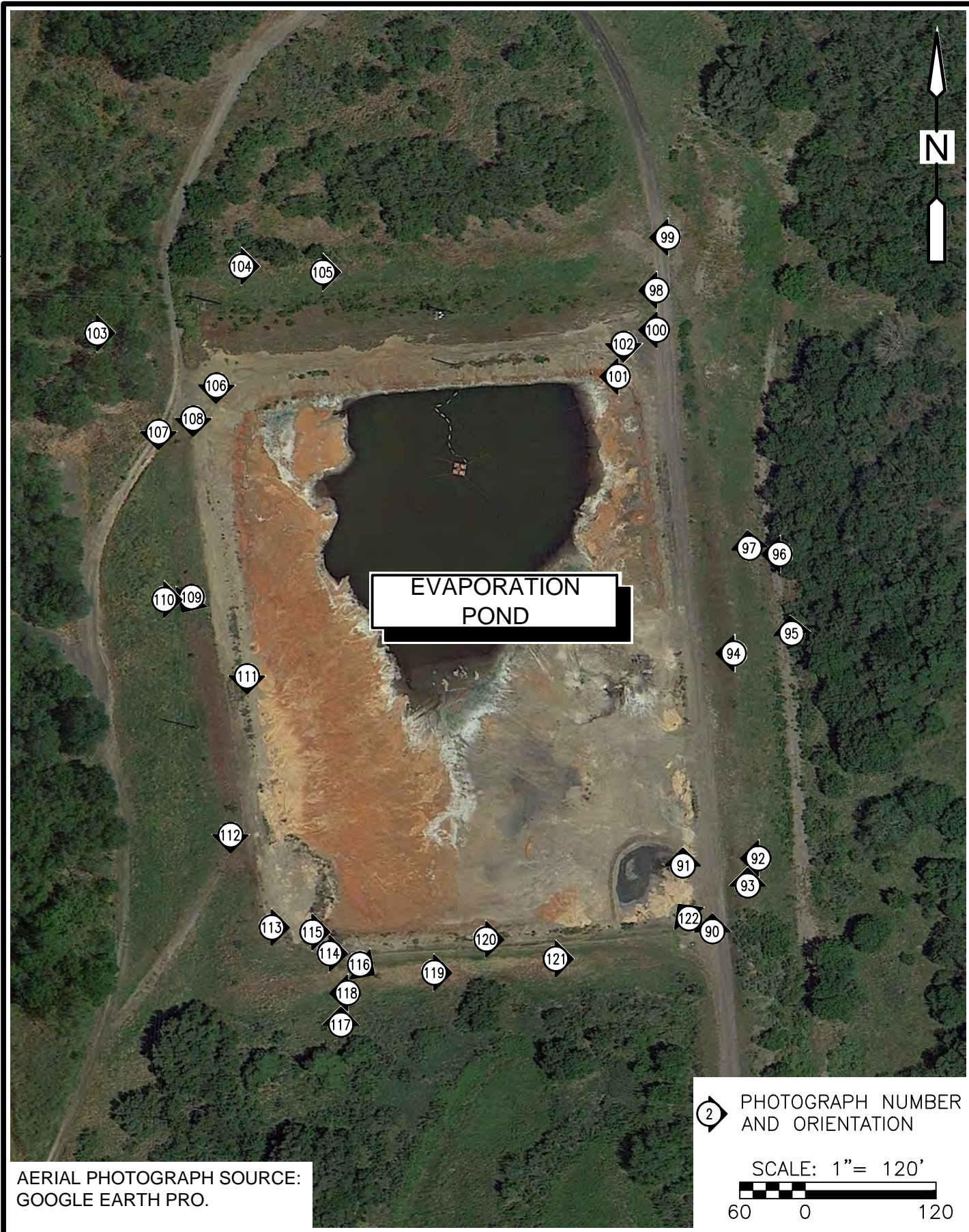

AERIAL PHOTOGRAPH SOURCE:
GOOGLE EARTH PRO.



J.T. DEELY POWER PLANT
SAN ANTONIO, TEXAS
EVAPORATION POND
FIGURE 5-4

Section 6

Hydrologic/Hydraulic Safety

6.1 Impoundment Hydraulic Analysis

Because they are off-channel impoundments, coal combustion waste impoundments are not classified as dams by the TCEQ. TCEQ regulates coal combustion waste impoundments as industrial waste impoundments and provides recommendations for construction, operation, and maintenance of all nonhazardous surface impoundments in “Technical Guideline No. 4, Topic: Nonhazardous Industrial Solid Waste Surface Impoundments”, dated June 12, 2009. The guidelines include the Hydrologic/hydraulic recommendation that surface water diversion dikes with a minimum height equal to two (2) feet above the 100-year flood water elevation should be constructed around industrial solid waste surface impoundments located within the 100-year flood plain. Industrial solid waste impoundments located above the 100-year flood water elevation should include surface water diversion dikes that are, at a minimum, capable of diverting all rainfall runoff from a 24-hour, 25-year storm.

FEMA guidance, as described in “*Selecting and Accommodating Inflow Design Floods for Dams; FEMA P-94 /August 2013*”, recommends hydrologic design of impoundments to consider discharge and storage capacities, reservoir regulation plans, land requirements, and wind/wave effects. FEMA guidelines recommend site-specific hydrologic design for high hazard impoundments which take into consideration the inflow design flood (IDF). FEMA recommends that dams with a low hazard potential be designed for a 1-percent annual chance of exceedance flood (average return frequency of no less than once in 100 years) and that dams with a significant hazard potential be designed for a 0.1-percent annual chance of exceedance flood (average return frequency of no less than once in 1,000 years).

The North and South Bottom Ash Ponds were classified as significant hazard impoundments and the Evaporation Pond was classified as a low hazard impoundment. Documentation provided by CPS included Turnkey Contract Documents prepared by Black & Veatch and dated December 31, 1987. These documents included precipitation amounts for selected storm durations and return periods expected in the Calaveras Lake area. Black & Veatch reported a precipitation of 7.75 inches for a 24-hour, 25-year storm, and precipitation ranging from 3.35 inches to 9.92 inches for 100-year storms ranging in duration from ½ hour to 24 hours. No documentation was provided by CPS on the site-specific IDF.

The drainage area contributing to the North and South Bottom Ash Ponds, and the Evaporation Pond appears to be limited to the surface area of the impoundments. A preliminary evaluation performed by CDM Smith suggests there is enough storage capacity under current operating pool levels for the North and South Bottom Ash Ponds to safely store precipitation from a 0.1-percent annual chance exceedance (1,000-year) flood. A preliminary evaluation performed by CDM Smith suggests there is enough storage capacity under current operating pool levels for the Evaporation Pond to safely store precipitation from a 1-percent annual chance exceedance (100-year) flood.

6.2 Adequacy of Supporting Technical Documentation

The hydrologic and hydraulic supporting documentation of the North and South Bottom Ash Ponds, and the Evaporation Pond is considered inadequate based on the following:

- H & H documentation provided by CPS included precipitation amounts for selected storm durations and return periods expected in the Calaveras Lake site area. No documentation was provided by CPS on the ability of the impoundments to store the FEMA-recommended design floods.
- An evaluation to determine the required IDF and of the capacity of the North and South Bottom Ash Ponds, and Evaporation Pond to withstand the design hydrologic/hydraulic events, without overtopping have not been provided.

6.3 Assessment of Hydrologic/Hydraulic Safety

Hydrologic and hydraulic safety of the North and South Bottom Ash Ponds and Evaporation Pond is considered adequate based on the following:

- CDM Smith's preliminary evaluation of the CCW impoundments suggests the North and South Bottom Ash Ponds and the Evaporation Pond have adequate storage capacity, based on normal operating conditions, to store the recommended floods.

It should be noted that during visual observations and site assessments, no signs of plugged, collapsed, or blocked pipes, or other detrimental conditions were observed.

Section 7

Structural Stability

7.1 Supporting Technical Documentation

The available information regarding slope stability of the North and South Bottom Ash Ponds and the Evaporation Pond consists of a report titled “Geotechnical Engineering Study for Ash Pond Berms – Spruce/Deely Generation Units, San Antonio, Texas”, prepared by Raba Kistner Consultants, Inc., (RKCI) and dated May 7, 2014. The RKCI May 2014 report supersedes RKCI’s November 12, 2012 report referenced in CDM Smith’s December 2012 “Assessment of Dam Safety of Coal Combustion Surface Impoundments , CPS Energy, J.T. Deely Power Plant”. RKCI’s 2014 report included slope stability analyses for steady-state and seismic loading conditions of the North and South Bottom Ash Pond and Evaporation Pond embankments. The calculated factors of safety presented in the RKCI 2014 report, for the load conditions analyzed, met minimum required factors of safety outlined by the USACE in EM 1110-2-1902, Table 3-1 and seismic factors of safety by *FEMA Federal Guidelines for Dam Safety, Earthquake Analyses and Design of Dams*. The RKCI 2014 report did not present analyses for liquefaction potential, end-of-construction, and rapid drawdown loading conditions. RKCI stated in the 2014 report that the end-of-construction condition was not evaluated due to the age of the ash ponds. RKCI also stated that both rapid drawdown and erosion failures are considered to be of very low risk due to the embankment toe elevations (above EL 490 feet) with respect to the target pool elevation (EL 485 feet) and because they would pose no risk of environmental contamination, because the pond must empty for this condition to occur. The RKCI 2014 report is included in Appendix A. A summary of the RKCI 2014 analyses is provided in the following sections.

7.1.1 Stability Analyses and Load Cases

TCEQ recommendations related to embankment stability of coal ash impoundments are included in “Technical Guideline No. 4, Topic: Nonhazardous Industrial Solid Waste Surface Impoundments”, dated June 12, 2009. TCEQ’s Technical Guideline No. 4 recommends all permanent earthen dikes that are used to retain waste or waste waters above ground level should have a top width of at least eight (8) feet and side slopes that are not steeper than one (1) foot vertical to three (3) feet horizontal. TCEQ’s recommended factor of safety against dike slope failure is at least 1.4. In situations where a backup system is not used for potential catastrophic failure of the dikes, TCEQ recommends a minimum factor of safety of 1.5.

Procedures established by the United States Army Corps of Engineers (USACE), the United States Bureau of Reclamation, the Federal Energy Regulatory Commission, and the Natural Resources Conservation Service are generally accepted engineering practice. Minimum required factors of safety outlined by the USACE in EM 1110-2-1902, Table 3-1 and seismic factors of safety by FEMA Federal Guidelines for Dam Safety, Earthquake Analyses and Design of Dams (pgs. 31, 32 and 38, May 2005) are provided in **Table 7-1**.

Table 7-1 - Recommended Minimum Safety Factors

Load Case	Minimum Required Factor of Safety
Steady-State Condition at Normal Pool or Maximum Storage Pool Elevation	1.5
Rapid Drawdown Condition from Normal Pool Elevation	1.3
Maximum Surcharge Pool	1.4
End of Construction	1.3
Seismic Condition at Normal Pool Elevation	1.0
Liquefaction	1.3

RKCI performed slope stability analyses for each of the embankments at the North and South Bottom Ash Ponds (Sections E, F, G, H, I and N) and all four of the Evaporation Pond embankments (Sections A, B, C, and D). Slope stability analyses were performed for steady-state seepage conditions at normal pool and maximum storage pool elevations, using effective stress analyses and for seismic conditions using total stress analyses. Analyses were performed with two feet of freeboard, and pond water levels at the top of the crest, corresponding to normal pool and maximum surcharge loading conditions, respectively. Seismic design parameters used in the seismic slope stability analyses included the mapped spectral response acceleration for an earthquake with a (0.098g) applied horizontal seismic load. RKCI indicated in their 2014 report that the applied horizontal seismic load had a 4-to-6 % probability of exceedance in 50 years. USEPA guidelines specify that the mapped spectral response acceleration for an earthquake with 2% probability of exceedance in 50 years be used in seismic slope stability analyses. CDM Smith used USGS referenced maps, published in the 2010 ASCE-7 Standard, to determine the mapped spectral response acceleration for an earthquake with 2% probability of exceedance in 50 years. CDM Smith found the spectral response acceleration for the Deely site to be 0.075g.

According to the 2014 RKCI report, rapid drawdown load conditions were not analyzed for slope stability, because the impoundments would have to be emptied for this condition to occur. The end-of-construction condition was not analyzed because the ponds have been in place for many years. According to information provided by RKCI, slope stability analyses for liquefaction conditions were not performed because liquefaction is very unlikely at the site due to the subsurface conditions and low seismic hazard level at the Plant site. As described in Section 1, CDM Smith agrees with RKCI's rationale for not performing these analyses.

7.1.2 Design Parameters and Dam Materials

CPS provided RKCI with field survey drawings for the embankments analyzed. According to the RKCI report, Pape Dawson Engineers, Inc. (PDE) spot-checked the existing embankments and surveyed cross-sections where the existing conditions did not closely resemble the earlier survey data. RKCI performed test soil borings at the embankment crests of the North and South Bottom Ash Ponds and Evaporation Pond. Seven borings were performed at the North and South Bottom Ash Ponds and four were performed at the Evaporation Pond. Soil and groundwater information obtained from these test borings were used in RKCI's slope stability analyses. The soil properties and strength parameters used in RKCI's steady-state seepage and seismic slope stability analyses are included in **Tables 7-2** and **7-3**, respectively. RKCI refers to the North and South Bottom Ash Ponds as Pond 2, and the Evaporation Pond as Pond 3.

Table 7-2 - Soil Parameters Used in RKC's Steady-State Slope Stability Analyses

Pond 2	Clay Fraction %	Assumed Liquid Limit	Normal Stress, psf			
			0	1,044	2,089	8,354
Embankment Soil (CL)	45	35	0	664	1,188	4,202
Sandy Clay (CL)	61	51	0	563	976	3,298
Clayey Sand (ML)	43	33	0	669	1,197	4,240

Pond 3	Clay Fraction %	Assumed Liquid Limit	Normal Stress, psf			
			0	1,044	2,089	8,354
Embankment Soil (CL)	45	45	0	640	1,145	4,023
Sandy Clay (CL)	50	54	0	557	963	3,247
Clayey Sand (ML)	34	55	0	618	1,105	3,859

Source: RKC May 7, 2014 report, "Geotechnical Engineering Study for Ash Pond Berms – Spruce/Deely Generation Units, San Antonio, Texas"

Table 7-3 - Soil Parameters Used in RKC's Seismic Slope Stability Analyses

Material	Unit Weight (pcf)	Cohesion (psf)	Phi (degrees)
Embankment Fill	120	350	20
Clayey Sand	120	400	20
Clayey Sand Below Water Table	57.6	400	20
Sandy Clay	120	500	20
Sandy Clay Below Water Table	57.6	500	20

Source: RKC May 7, 2014 report, "Geotechnical Engineering Study for Ash Pond Berms – Spruce/Deely Generation Units, San Antonio, Texas"

According to the RKC report, soil parameters (drained cohesion and drained friction angle) for steady-state seepage analyses were selected based on consolidated undrained triaxial compression test results at four different normal stresses and published correlations. The strength parameters selected for the seismic analyses were based on unconfined compressive strength results and experience with similar soils.

7.1.3 Uplift and/or Phreatic Surface Assumptions

According to the 2014 RKC report, steady-state seepage analyses were performed for each profile using finite element groundwater module within SLIDE, a software program developed by RocScience. The seepage analyses were performed for each embankment cross-section with water levels at the embankment crests. Results of the seepage analyses were used for the steady-state seepage and seismic slope stability analyses.

7.1.4 Factors of Safety and Base Stresses

A summary of safety factors computed for the different cases of the North and South Bottom Ash Ponds (Sections E, F, G, H, I, J, and N) and Evaporation Pond (Sections A, B, C, and D) is included in **Table 7-4**.

A factor of safety of 1.2 was calculated for the exterior slope of cross-section G. RKCI addressed the low factor of safety for cross-section G in their report stating the slope failure surface was relatively shallow and did not appear to threaten the pond. The analysis was rerun considering deeper slope failure surfaces and achieved a factor of safety of 1.4. The factor of safety of 1.4 for Section G is below the minimum factor of safety recommended by the USACE for long-term, steady-state normal pool conditions. Calculated factors of safety for all other cross-sections analyzed, other than Section G, were greater than USACE specified minimum factors of safety. Based on furnished information, there are no other notable events since original startup of the North and South Bottom Ash Ponds. During the site assessment by CDM Smith, no significant deficiencies were observed at the South Bottom Ash Pond and Evaporation Pond. Based on the history free notable events and CDM Smith's observations, it is likely that the slope is stable under the conditions it has experienced. Therefore, the calculated factor of safety for Section G of the North Bottom Ash Pond, that is lower than the required factor of safety, is likely not of significant concern.

Table 7-4, Computed Factors of Safety for Various Stability Conditions

Embankment Cross-Section	Factor of Safety Steady-State Stability Analyses ⁽¹⁾		Required Safety Factor	Factor of Safety Factor of Safety ⁽²⁾		Required Safety Factor	Factor of Safety Seismic Stability Analyses		Required Safety Factor	
	Interior Slope	Exterior Slope		Interior Slope	Exterior Slope		Interior Slope	Exterior Slope		
North and South Bottom Ash Ponds	E	>2	>2	1.5	>2	>2	1.4	>2	>2	1.0
	F	>2	>2		>2	>2				
	G	>2	1.2/1.4 ⁽³⁾		>2	1.4		>2	1.9	
	H	>2	>2		>2	>2		>2	>2	
	I	>2	1.8		>2	>2		>2	>2	
	J	>2	>2		>2	>2		>2	>2	
	N	>2	1.6		>2	>2		>2	>2	
Evaporation Pond	A	>2	>2	>2	>2	>2	>2	>2		
	B	>2	>2	>2	>2	>2	>2			
	C	>2	1.5	>2	>2	>2	>2			
	D	>2	1.9	>2	>2	>2	>2			

Source: RKCI May 7, 2014 report, "Geotechnical Engineering Study for Ash Pond Berms – Spruce/Deely Generation Units, San Antonio, Texas".

1. Normal Pool
2. Maximum Surcharge
3. See discussion in Section 7.1.4.

7.1.5 Liquefaction Potential

CDM Smith was not provided documentation on liquefaction analysis. RKCI stated that liquefaction is very unlikely at the site due to the subsurface soil and groundwater conditions, and seismic conditions at the Plant site. As reported by RKCI, there is less than a 0.1% chance of an earthquake with magnitude of 5.0 or greater in 50 years. Because the site contains significant quantities of relatively stiff clay, RKCI believes the soils beneath the existing embankments have a very low risk of experiencing liquefaction due to an earthquake. Available subsurface information indicates the soils below the embankments consist of fill underlain by medium dense to very dense sandy soils and/or

very stiff sandy clay. The liquefaction susceptibility of the dense sandy soils and the stiff clay is generally considered to be low.

7.1.6 Critical Geological Conditions

According to the Quaternary Geologic Map of the Austin 4 x 6 Quadrangle published by the United States Geological Survey, geology in the vicinity of the Plant consists of gray, light brown, brown, or orange clayey, fine to medium quartz sand to fine sandy silty clay with subrounded sandstone pebbles, colluviums, and small bedrock outcrops in some localized areas. According to the United States Department of Agriculture, surface soils in the area are comprised of fine sand, loamy fine sand, and sandy clay loam.

7.2 Adequacy of Supporting Technical Documentation

Existing conditions and visual observations yield a satisfactory rating for structural stability of both the North and South Bottom Ash Ponds, and Evaporation Pond based on the following:

- Steady-state and seismic stability analyses for of the North and South Bottom Ash Ponds and Evaporation Pond embankments are documented.
- RKCI provided assessments of the embankments' liquefaction potential, and structural stability applicable for end of construction and sudden drawdown loading conditions. RKCI did not analyze liquefaction potential, end of construction and sudden drawdown loading conditions. As described above, CDM Smith agrees with RKCI's rationale for not performing analyses for these loading conditions.
- In their seismic slope stability analyses, RKCI used the mapped spectral response acceleration of 0.098g from the USGS web site calculator. Using USGS referenced maps, published in the 2010 ASCE-7 Standard, CDM Smith determined the mapped spectral response acceleration for an earthquake with 2% probability of exceedance in 50 years to be 0.075g. Accordingly, in CDM Smith's opinion, the response acceleration employed in RKCI's seismic analyses conforms to USEPA standards.

7.3 Assessment of Structural Stability

Based on the review of the stability analyses and visual observations made during the site visit, CDM Smith considers the condition rating to be satisfactory for structural stability of the North and South Bottom Ash Ponds and Evaporation Pond.

During CDM Smith's visual observations and site assessments of the North Bottom Ash Pond and Evaporation Pond, the high water and solids level in the impoundments prevented observation of the interior slopes.

Section 8

Adequacy of Maintenance and Methods of Operation

8.1 Operating Procedures

During normal operating procedures the North and South Bottom Ash Ponds receive sluiced bottom ash, low volume waste, and metal cleaning waste from the J.T. Deely Power Plant. Liquids are discharged near the center of each impoundment. Within both ponds, an outlet structure includes a vertical outlet pipe with invert elevation at El. 499 that typically maintains approximately 2 feet of freeboard. A drain pipe near the vertical outlet is closed during normal operating procedures, but is opened to drain the ponds for cleaning. The drain pipe has an invert elevation at El. 489. A metal sheet pile wall with an opening surrounds the outlet pipes. During the site assessment a floating sorbent boom was observed across the opening in the sheet pile wall.

A second drain pipe is located on the embankment opposite the outlet structures in both ponds. This second drain pipe is closed during normal operating procedures, but can be opened to transfer liquids from the ponds to the Plant. Settled solids are periodically excavated from the North and South Bottom Ash Pond and sold for beneficial use. During the site assessment the North Bottom Ash Pond contained water and ash material, and the South Bottom Ash Pond was drained for cleaning out ash and replacing inlet piping. According to CPS representatives, the target pool level in the Ash Pond is at least 2 feet of freeboard. Liquids from the North and South Bottom Ash Pond are discharged into Calaveras Lake through an outfall just south of the ponds.

During normal operating procedures, the Evaporation Pond receives boiler chemical cleaning wastes generated by the J.T. Deely Power Plant and J.K. Spruce Power Plant that are trucked to the pond. The wastes are dewatered through evaporation. No liquids are discharged from the Evaporation Pond. During the site assessment, ash material and other solids extended up to 0.5 to 2 feet below the crest.

8.2 Maintenance of the Dam and Project Facilities

CPS indicated during the site assessment by CDM Smith on August 27 and 28, 2012, that visual inspections are performed for the North and South Bottom Ash Ponds twice a day when water level readings are measured. These inspections are only documented if irregularities are observed. No formal inspections of the Evaporation Pond are performed.

Regular maintenance operations include mowing adjacent to the North and South Bottom Ash Ponds and Evaporation Pond.

8.3 Assessment of Maintenance and Methods of Operations

8.3.1 Adequacy of Operating Procedures

Based on CDM Smith's visual observations and review of documents provided by CPS, operating procedures appear to be generally adequate for the impoundments. There is no readily available

indication that suggests that the North and South Bottom Ash Ponds and Evaporation Pond primary purposes are not being accomplished.

8.3.2 Adequacy of Maintenance

Based on CDM Smith's visual observations and review of documents provided by CPS, maintenance of the North and South Bottom Ash Ponds and the Evaporation Pond appear to be generally adequate. Maintenance issues at the North Bottom Ash Pond included minor areas of erosion into ash on the west embankment interior slope, and trees and vegetation on the north embankment exterior slope. Maintenance issues on the shared divider embankment between the North Bottom Ash Pond and the South Bottom Ash Pond included minor areas of slope erosion into ash. Maintenance issues on the exterior slopes of the Evaporation Basin included areas of loose soil and exposed soil, and an animal burrow.

Section 9

Adequacy of Surveillance and Monitoring Program

9.1 Surveillance Procedures

CPS is required by Texas Commission on Environmental Quality (TCEQ) under National Pollutant Discharge Elimination System (NPDES) Permit No. WQ0001514000 to monitor discharge of wastewater into Calaveras Lake. Surveillance procedures should be in accordance with the TCEQ – NPDES Permit.

CPS indicated that they do a general inspection of the North and South Bottom Ash Ponds twice a day and notes are made if any irregularities of the embankments are observed. There are no known surveillance procedures other than measuring water levels and checking for deficiencies at both the North and South Bottom Ash Ponds. Water levels are measured and recorded twice a day for the North and South Bottom Ash Ponds. Water levels are measured from a reference level at the invert elevation of the vertical outlet pipes at El. 499 at both of the ponds. Water level documentation from August 2012 is included in Appendix C.

According to CPS, no surveillance procedures exist for the Evaporation Pond.

9.2 Instrumentation Monitoring

The North and South Bottom Ash Ponds and Evaporation Pond embankments do not have an instrumentation monitoring system to monitor structural stability, seepage, or ground displacement. As previously mentioned, water levels in the North and South Bottom Ash Ponds are measured manually twice a day. Water levels are not monitored in the Evaporation Pond.

9.3 Assessment of Surveillance and Monitoring Program

9.3.1 Adequacy of Inspection Programs

Based on the documents reviewed by CDM Smith and visual observations during the site assessment, the inspection program appears to be adequate for the North and South Bottom Ash Ponds, though the inspections should be documented in the future. Inspection programs do not exist for the Evaporation Pond and are inadequate.

9.3.2 Adequacy of Instrumentation Monitoring Program

The CPS surveillance program for the North and South Bottom Ash Ponds is considered adequate. The CPS surveillance program for Evaporation Pond is considered inadequate.

Section 10

Reports and References

The following is a list of reports and drawings that were provided by CPS and were used during the preparation of this report and the development of the conclusions and recommendations presented herein.

1. J.T. Deely Unit 1 Construction Drawings by Black & Veatch Consulting Engineers, dated 1974.
2. Turnkey Contract Documents Volume 4 by Utility Engineering Corporation, dated December 31, 1987,
3. J.K. Spruce Unit 1 Construction Drawings by Utility Engineering Corporation, dated 1989.
4. J.T. Deely/J.K. Spruce Construction Drawings by Frank Tobar, dated 1990.
5. Daily water level readings recorded between August 1, 2012 and August 16, 2012.
6. Raba Kistner Consultants, Inc. Geotechnical Engineering Study, Ash Pond Berms – Spruce/Deely Generation Units, dated November 20, 2012.
7. Raba Kistner Consultants, Inc. Geotechnical Engineering Study, Ash Pond Berms – Spruce/Deely Generation Units, dated May 7, 2014.

Appendix A

RKCI Geotechnical Engineering Study



GEOTECHNICAL ENGINEERING STUDY

FOR

**ASH POND BERMS - SPRUCE/DEELY GENERATION UNITS
SAN ANTONIO, TEXAS**



Raba Kistner
 Consultants, Inc.
 12821 W. Golden Lane
 San Antonio, TX 78249
 P.O. Box 690287
 San Antonio, TX 78269
 www.rkci.com

P 210 :: 699 :: 9090
 F 210 :: 699 :: 6426
 TBPE Firm F-3257

Project No. ASA12-098-00 (Revised)
 May 7, 2014

Mr. Eric R. Olson
 CPS Energy
 c/o Mr. Steven Dean, P.E.
 Pape-Dawson Engineers, Inc.
 555 East Ramsey
 San Antonio, Texas 78216

**RE: Geotechnical Engineering Study
 Ash Pond Berms – Spruce/Deely Generation Units
 San Antonio, Texas**

Dear Mr. Dean:

Raba Kistner Consultants Inc. (RKCI) is pleased to submit the revised report of our Geotechnical Engineering Study for the above-referenced project. This study was performed in accordance with RKCI Proposal No. PSA12-168-00 (3rd Revision), dated October 4, 2012, and comments provided in a conference call on April 17, 2014. The purpose of this study was to drill borings within the existing ash pond berms, to perform laboratory testing to classify and characterize subsurface conditions, and to prepare an engineering report presenting slope stability analyses for the existing berms.

We appreciate the opportunity to be of service to you on this project. Should you have any questions about the information presented in this report, or if we may be of additional assistance with value engineering or on the materials testing-quality control program during construction, please call.

Very truly yours,

RABA KISTNER CONSULTANTS, INC.

R. Blake Wright

R. Blake Wright, E.I.T.
 Graduate Engineer

RBW/JAF/EJN

Attachments

Copies Submitted: Above (4)



Eric J. Neuner
 Eric J. Neuner, P.E.
 Manager, San Antonio Engineering



GEOTECHNICAL ENGINEERING STUDY

For

**ASH POND BERMS – SPRUCE/DEELY GENERATION UNITS
SAN ANTONIO, TEXAS**

Prepared for

PAPE-DAWSON ENGINEERS, INC.
San Antonio, Texas

Prepared by

RABA KISTNER CONSULTANTS, INC.
San Antonio, Texas

PROJECT NO. ASA12-098-00 (Revised)

May 7, 2014

TABLE OF CONTENTS

INTRODUCTION 1

PROJECT DESCRIPTION 1

RISK 1

LIMITATIONS 1

BORINGS AND LABORATORY TESTS..... 2

 pH TESTING 3

\bar{C}_u TESTS 4

 DIRECT SHEAR TESTS 4

 LIQUID DENSITY TESTS 4

 FLY ASH SPECIFIC GRAVITY TESTING 5

 MOISTURE-DENSITY TESTING..... 5

GENERAL SITE CONDITIONS..... 6

 SITE DESCRIPTION..... 6

 GEOLOGY 6

 STRATIGRAPHY 6

 GROUNDWATER 6

EARTHEN BERMS..... 7

 DESIGN CONSIDERATIONS 7

 Probable failure modes 7

 SLOPE STABILITY 8

 Minimum Factor of Safety..... 8

 Slope Configurations 9

 Method of Analysis..... 9

 Loading Conditions 10

 SOIL PARAMETERS..... 11

 Results of Analyses 12

 SEEPAGE ANALYSIS..... 13

 EARTHQUAKE ANALYSES..... 14

 Results of Quasi-Static (Seismic) Analyses 14

RESULTS 15

CONCLUSIONS..... 16

TABLE OF CONTENTS

ATTACHMENTS

Appendix A (Field Data)

Boring Location MapA-1
Logs of Borings A-2 through A-15
Key to Terms and SymbolsA-16

Appendix B (Laboratory Test Results)

Results of Soil Sample Analyses B-1
Unconfined Compression Test Reports B-2 through B-5

Appendix C (Slope Stability Analyses)

Slope Profile Locations C-1
Slope Stability and Seepage Analyses (Steady State)..... C-2 through C-15
Slope Stability and Seepage Analyses (Maximum Pool) C-16 through C-29

Appendix D (Seismic Analyses)

USGS Design Maps Summary Report D-1 and D-2
USGS Design Maps Detailed Report..... D-3 through D-11
Seismic Intensity Scales vs Peak Ground Acceleration D-12 and D-13
Slope Stability Analyses (Steady State) D-14 through D-27
Slope Stability Analyses (Maximum Pool) D-28 through D-41

INTRODUCTION

Raba Kistner Consultants Inc. (RKCI) has completed the authorized subsurface exploration and slope stability analyses for the existing ash pond berms at the Spruce/Deely Generation Units in San Antonio, Texas. This report briefly describes the procedures utilized during this study and presents our findings along with our recommendations for maintaining the existing ash pond berms.

PROJECT DESCRIPTION

The structures being considered in this study include the existing ash pond berms located at the Spruce/Deely Generation Units, which is operated by CPS Energy. Specifically, three ponds were studied and are denoted on the Boring Location Map, Figure 1. Our understanding of the slope profile at each berm, as well as the existing site topography, is based on several drawings provided to us on September 14, November 1, 2012, and May 6, 2014 by Mr. Steven Dean, P.E., with Pape-Dawson Engineers, Inc.

RISK

The geotechnical engineering recommendations contained in this memorandum are intended to provide Pape-Dawson Engineers, Inc; CPS Energy; and the U.S. Environmental Protection Agency with information pertaining to the stability of the existing ash pond berms at the Spruce/Deely Generation Units .

The geotechnical properties of the soils encountered in this study involve variability. This variability includes some spatial variability; however, the spatial variability appears to occur over relatively short distances. It is important to note that berms differ from other types of structures, such as drilled piers or driven piles, in that the performance of the berm involves local, not average, soil conditions.¹ The selection of analysis parameters for this project was based on a review of the available geotechnical data, our knowledge of the project area, and design calculations using select surveyed geometries. The results of our analyses were then reviewed with respect to important trends and general concepts, keeping these conditions and limitations in mind. Our conceptual recommendations are based on a conservative approach as is warranted for all slope stability analyses. We believe that the combination of observed conditions and probable failure modes justifies this approach.

LIMITATIONS

This engineering report has been prepared in accordance with accepted Geotechnical Engineering practices in the region of south/central Texas and for the use of Pape-Dawson Engineers, Inc. (CLIENT) and its representatives for design purposes. This report may not contain sufficient information for purposes of other parties or other uses. This report is not intended for use in determining construction means and methods.

¹ Focht, J.A. Jr. and Focht, J.A. III, "Factor of Safety and Reliability in Geotechnical Engineering, Discussion and Closure", ASCE JGGE Vol. 127 No. 8, pp.700-721, August 2001.

The recommendations submitted in this report are based on the data obtained from 14 borings drilled at this site and our understanding of the project information provided to us. If the project information described in this report is incorrect, is altered, or if new information is available, we should be retained to review and modify our recommendations.

This report may not reflect the actual variations of the subsurface conditions across the site. However, it is important to note that a significant portion of the apparent site variability is due to variation in the proportions of sand and clay in the native soils. These variations cause the soil classification to change between borings, while our experience indicates the behavior of these soils varies within a relatively narrow range.

The scope of our Geotechnical Engineering Study does not include an environmental assessment of the air, soil, rock, or water conditions either on or adjacent to the site. No environmental opinions are presented in this report.

BORINGS AND LABORATORY TESTS

Subsurface conditions at the site were evaluated by 14 borings drilled at the locations shown on the Boring Location Map, Figure A-1. These locations are approximate and distances were measured using a recreational-grade, hand-held GPS locator; tape; angles; pacing; etc. Ground surface elevations were estimated from the topography depicted on the above-referenced drawings provided by Mr. Dean. The estimated ground surface elevation at each of the boring locations is listed in the table below as well as the approximate bottom elevation of each boring.

Boring No.	Ground Surface Elevation (ft, MSL)	Boring Bottom Elevation (ft, MSL)
B-1	522	472
B-2	523	473
B-3	522	472
B-4	523	473
B-5	501	461
B-6	500	460
B-7	500	470
B-8	501	461
B-9	499	469
B-10	496	456
B-11	496	466
B-12	500	470
B-13	496	456
B-14	501	461

The borings were drilled using a truck-mounted drilling rig. During drilling operations, the following samples were collected:

Type of Sample	Number Collected
Split-Spoon (with Standard Penetration Test)	126
Undisturbed Shelby Tube	28

Each sample was visually classified in the laboratory by a member of our Geotechnical Engineering staff. The geotechnical engineering properties of the strata were evaluated by the following tests:

Type of Test	Number Conducted
Natural Moisture Content	151
Atterberg Limits	29
Percent Passing a No. 200 Sieve	33
Direct Shear	2
Consolidated-Undrained ($\bar{C}U$) Triaxial	10
Unconfined Compression	17
Dry Unit Weight	17

With the exception of the $\bar{C}U$ triaxial and direct shear tests, the results of the field and laboratory tests are presented in graphical or numerical form on the boring logs illustrated on Figures A-2 through A-15. A key to classification terms and symbols used on the logs is presented on Figure A-16. The results of the laboratory and field testing are also tabulated on Figure B-1 for ease of reference.

Standard penetration test results are noted as “blows per ft” on the boring logs and Figure B-1, where “blows per ft” refers to the number of blows by a falling hammer required for 1 ft of penetration into the soil/weak rock. Where hard or dense materials were encountered, the tests were terminated at 50 blows even if one foot of penetration had not been achieved. When all 50 blows fall within the first 6 in. (seating blows), refusal “ref” for 6 in. or less will be noted on the boring logs and on Figure B-1.

Samples will be retained in our laboratory for 30 days after submittal of this report. Other arrangements may be provided at the request of the Client.

pH TESTING

Seepage from the ash ponds would most likely result in an increase pH in the embankment soils. As a part of our laboratory study, we evaluated the collected soil samples using a phenolphthalein solution. We customarily screen for pH in order to prevent chemical burns to our laboratory staff, who typically work with the samples bare-handed.

No reaction to the phenolphthalein solution was noted in any of the samples tested. This would indicate that all samples tested had a pH value of less than 8.

C_u TESTS

Multi-stage \bar{C}_u tests were used to measure both total and effective soil strength parameters of harvested samples from the project site. During \bar{C}_u testing, each stage was subjected to a range of effective consolidation pressure.

The following table presents the results of our multi-stage \bar{C}_u tests:

Boring No.	Depth (ft)*	Effective		Total		Stress Path	
		Friction Angle, ϕ' (degrees)	Cohesion, c' (psf)	Friction Angle, ϕ (degrees)	Cohesion, c (psf)	Friction Angle, ϕ (degrees)	Cohesion, c (psf)
B-2	13-15	18.6	1,350	20.2	1,390	19.1	1,310
B-3	18-20	21.7	1,130	22.7	1,220	25.9	1,060
B-5	8-10	28.0	730	30.0	1,020	29.5	720
B-7	8-10	28.3	2,040	-	-	36.2	560
B-9	8-10	33.6	0.0	38.6	0.0	24.0	1,070
B-12	8-10	27.2	1,160	34.9	1,090	31.3	860

*Depth below the top of berm surface elevation existing at the time of our field study.

DIRECT SHEAR TESTS

Direct shear tests were performed on two samples collected during drilling operations. The results of these tests are presented in the table below:

Boring No.	Depth (ft)	Apparent Cohesion (psf)	Phi (degrees)
B-3	28.5 - 30	62	27
B-5	38.5 - 40	72	34

LIQUID DENSITY TESTS

Three one-gallon liquid samples were collected at the site on April 22, 2014. These samples were collected from the Evaporation Pond, North Bottom Ash Pond, and the North SRH Pond. The densities of these liquids are presented in the following table:

Sample Location	Density (pcf)
Evaporation Pond	61.0
North Bottom Ash Pond	60.6

Sample Location	Density (pcf)
North SRH Pond	60.7

FLY ASH SPECIFIC GRAVITY TESTING

Two samples of fly ash sludge were collected at the site on April 22, 2014 to calculate the specific gravity of the fly ash. The calculated specific gravities are presented in the table below:

Sample Location	Specific Gravity
North Bottom Ash Pond	2.59
South Bottom Ash Pond	2.60

MOISTURE-DENSITY TESTING

The density of the at surface material in the dry portions of the ponds was measured on April 22, 2014 using a nuclear density gauge. The results of these tests are presented in the tables below:

Pond	Sample Location	Wet Density (pcf)	Moisture Content (%)	Dry Density (pcf)
Evaporation Pond	West Edge of Pond	94.2	33.3	70.7
		92.9	40.0	66.4
		92.0	31.1	70.2
		95.2	31.5	72.4
		92.6	35.5	68.4
		94.4	34.5	70.2
North Bottom Ash Pond	East and Southeast Edge of Pond	106.3	18.0	90.1
		111.2	19.0	93.4
		107.3	24.2	86.4
		112.9	17.9	95.8
		110.7	21.5	91.1
		107.6	24.9	86.2
South Bottom Ash Pond	Center of Pond	118.0	18.0	100.0
		122.2	16.3	105.1
		119.5	16.2	102.9
		114.6	19.2	96.2
		106.7	23.6	86.4
		115.5	17.7	98.1

GENERAL SITE CONDITIONS

SITE DESCRIPTION

The project site is a tract of developed land located at the Spruce/Deely Generation Units , which is operated by CPS Energy. The ash ponds considered in this study are located east and northeast of the existing main power plant facility. The entire facility is bounded to the west, south, and east by Calaveras Lake. The topography generally slopes downward toward Calaveras Lake. CPS maintains the Calaveras Lake at a target pool elevation of Elevation 485 feet with periodic fluctuations of plus or minus one foot. Levels above the target pool elevation are usually due to rainfall in the Calaveras Creek, Hondo Creek and Chupaderas Creek watersheds, and typically return to the target pool elevation within a few days of the rain event.

GEOLOGY

A review of the *Geologic Atlas of Texas, San Antonio Sheet*, indicates that this site is naturally underlain with the soils/rocks of the Wilcox Group, which is composed of mudstone with varying amounts of sandstone and lignite. The Wilcox Group may weather to yellowish-brown clay, sandy clay, clayey sands, and sands.

The Wilcox Group grades downward into the Midway Group, which is composed of clay, silt, and sand, with some pebbles near its base. Glauconite is often encountered in these soils. Key engineering considerations for development supported on the soils/rock of this formation typically include the presence of possible water-bearing layers, very hard mudstone/sandstone layers, and the expansive nature of the highly plasticity clays that can be present in this formation.

STRATIGRAPHY

The subsurface stratigraphy at this site varies from pond to pond, and berm to berm. However, the embankment fill soils typically consist of sandy clay or clayey sand. It is difficult to distinguish between these two soil types in the berms because the percent passing a No. 200 sieve ranges within about 10 percentage points higher and lower than 50%. The subgrade stratigraphy is also generally composed of interbedded sandy clay and clayey sand. There were also isolated tan and gray clay seams encountered in our borings. Each stratum has been designated by grouping soils that possess similar physical and engineering characteristics. The boring logs should be consulted for more specific stratigraphic information. The lines designating the interfaces between strata on the boring logs represent approximate boundaries. Transitions between strata may be gradual, which vary within a relatively narrow combined range of Plasticity Index and -200 values.

GROUNDWATER

The depth to groundwater was measured in all borings except Boring B-1. The groundwater level in Boring B-1 could not be measured due to the introduction of drilling fluids in this boring.

Upon completion of the drilling operations, groundwater levels ranged from 11 to 17 ft below the existing ground surface in the borings drilled for Ponds 1 and 2. Groundwater levels ranged from 40 to 42 ft below the existing ground surface in the borings drilled for Pond 3 (with the exception of Boring B-1).

As mentioned previously, this site is bounded to the west, south, and east by Calaveras Lake. The groundwater levels encountered at this site are most likely dominated by the surface water elevation of Calaveras Lake. Fluctuations in groundwater levels are possible due to variations in rainfall and surface water run-off.

EARTHEN BERMS

DESIGN CONSIDERATIONS

The existing berms should meet three important criteria: they should be resistant to the forces of erosion, should exhibit a suitable slope stability design allowable factor of safety with respect to long-term, short-term, and sudden drawdown conditions, as well as performance type scenarios such as underseepage. The berm structure must meet these criteria so that the calculated risk of failure is consistent with criteria established by the USACE guidelines.

Probable failure modes

Our review of the site and expected conditions for the Calaveras Power Plant ash ponds indicates that the following major modes of failure could affect the berms:

- Slope stability
- Underseepage
- Embankment Seepage

The following sections address each of these failure modes, as well as slope erosion and liquefaction.

Slope Stability Based on our review of available data and our visual observations during drilling, the existing embankments exhibit slopes ranging from about 3:1 (horizontal:vertical) or flatter, while a few limited areas exhibit slopes of about 2.5:1.

In general, slopes flatter than 3:1 would be expected to exhibit the required factors of safety for a normal (non-flood) seepage condition with the area water table near Elevation 485 feet.

Underseepage We generally consider underseepage to be a very low risk for the existing berms. Underseepage consists of water flowing beneath the embankment as a result of water seeping out of the ash ponds. The principal failure mechanism related to underseepage occurs when the upward force of the water equals or exceeds the buoyant weight of the soil. This does not appear likely to occur at this project site.

Berm Seepage Embankment seepage consists of water flowing through the berm as a result of seepage through the berm. The principal failure mechanism related to embankment seepage occurs when the horizontal force of the water equals or exceeds the effective shear strength of the soil. This mode of failure is not expected to occur at this project site.

Slope Erosion The existing embankments are generally composed of cohesive soils, while the underlying soils are generally composed of cohesive soils with layers semi-cohesive soils. It appears that the existing embankments were constructed using the soils available at the project site. These materials are generally considered acceptable to good materials to use when constructing berms, dams and slopes. In addition, the berms are not expected to be exposed to flowing water, other than rain that falls on the berm crest and berm slopes. The risk of berm failure due to erosion is considered to be very low.

Liquefaction Soil liquefaction results from loss of strength during cyclic loading, such as imposed by earthquakes. Soils most susceptible to liquefaction are clean, loose, saturated, uniformly graded, and fine-grained sands. Empirical evidence indicates that loose silty sands are also potentially liquefiable. When seismic ground shaking occurs, the soil is subjected to cyclic shear stresses that can cause excess hydrostatic pressures to develop. If excess hydrostatic pressures reach the effective confining stress from the overlying soil, the sand may undergo deformations. If the sand undergoes virtually unlimited deformation without developing significant resistance, it is said to have liquefied, and if the sand consolidates or vents to the surface during and following liquefaction, ground settlement may occur.

The soils contain significant quantities of clay, and are relatively dense. Even when groundwater is present, the berms have a very low potential for liquefaction during earthquake events, particularly since the USGS online resources indicate there is less than 0.1 percent chance of experiencing a magnitude 5.0 or greater earthquake at this site during a 50 year period. In addition, calculations performed using the Seed and Idriss method indicate the most susceptible tested sample must experience a ground acceleration in excess of 0.44g before liquefaction will occur. Based on these findings, RKCI believes the soils beneath the existing berms have a very low risk of experiencing liquefaction due to an earthquake.

SLOPE STABILITY

This section presents our slope stability analyses performed for this study. In general, the procedures described in USACE EM 1110-2-1902 *Slope Stability* were followed. As such, our analysis focused on embankment stability, settlement, interior drainage, and slope protection.

The slope configurations analyzed, method of analysis, loading conditions, and soil properties used in the analyses are discussed in the following paragraphs.

Minimum Factor of Safety

For a given slope configuration, the forces that “drive” slope failure (including gravity, groundwater seepage pressure, and possible excess pore water pressures from external loading conditions) are compared to the slope’s resistance to failure, which is a function of dewatering controls and internal shear strength (cohesion and internal angle of friction) of both the foundation soils and the fill soils utilized for construction of the embankment.

The USACE has specified minimum safety factors against slope failure with respect to loading conditions. The minimum acceptable factors of safety for berms at end of construction, rapid drawdown, and steady state conditions, provided in Table 3-1 on Page 3-2 of EM 1110-2-1902, are listed in the following table. The minimum safety factor against slope failure during an earthquake is customarily assumed to be a calculated value greater than 1.0 where the risk of loss of life is low and the structure is not deemed critical in nature (hospitals, emergency services, etc.)

Condition	Required Factor of Safety
End of Construction	1.3
Sudden Drawdown	1.1 to 1.3
Long Term (Steady Seepage)	1.4
Earthquake	Greater than 1.0

We consider a significant slope failure to involve a volume of slope material that is large enough to substantially impair the serviceability or operation of the berm or that could imperil human life. Shallow, sloughing slope failures that involve relatively little material or that can be repaired locally without substantially impacting the ash pond operations are considered to be minor slope failures and do not control the conclusions of our stability analyses.

Slope Configurations

At the time this technical report was prepared, field surveys drawings of the existing berms had been performed by Pape Dawson Engineers, Inc. As a part of their work, we understand that Pape Dawson spot-checked the existing berms, and only provided surveyed cross-sections where the existing condition did not closely resemble the original drawings. As such, we have provided the original design geometry for the purposes of our study for the select berms. Figure C-1 shows the profiles that were surveyed and those that are based on the design drawings.

We recognized four general soil conditions along the length of the alignment that may be considered as worst-case boundary conditions. As such, four cases were analyzed based on these boundary conditions.

Method of Analysis

The slope stability analyses for this study were conducted with the aid of a computer using the program SLIDE developed by RocScience. The SLIDE computer program randomly generates trial failure surfaces and evaluates the factor of safety for each trial surface. The program allows a large number of potential shear surfaces to be investigated to determine the critical failure surface for each of the analyzed slope configurations.

The portions of the program used in this study employed both the Morgenstern-Price and Spencer computational methods. These methods were used to make calculations of the stability of slopes where non-circular failure surfaces were permitted. In each case, the computed factor of safety is the ratio of the forces resisting movement to the driving forces. A factor of safety of 1.0 or less implies the slope is unstable, while a factor of safety greater than 1.0 implies the slope is stable.

Loading Conditions

For satisfactory performance, an earth embankment should have an acceptable factor of safety during construction and throughout its projected service lifetime. Stability analyses should include variations in stress conditions brought on by construction practices and sequencing, external loadings, and any anticipated changes in hydraulic conditions. The following paragraphs discuss each stability condition analyzed in our study.

External Loads External loads for the roadways along the berm crest have also been modeled. A traffic loading of HS20 (modeled as an equivalent uniform surcharge of 100 psf) was applied to the crest of the berm.

Liquid/Sludge Loads Based on the results of the density testing performed on the samples collected on April 22, 2014, we have included additional loads on the analyses conducted for the “dry side” of the berms.

These loads account for the increase in pressure in the bottom of the ponds and along the berm slopes due to weight of the sludge and/or liquid in the ponds. The increase in the pressure due to this material is modeled in our analysis.

These loads were not applied to the “pond side” analyses due to the increase in factors of safety from this loading condition.

End of Construction The short-term (undrained) loading condition models the slope immediately following construction. For this loading condition, the pore pressures developed during construction have not had the opportunity to dissipate. We did not analyze this condition since the berms have been in place for many years.

Steady State Seepage The long term (drained), steady-state seepage loading condition was analyzed. This loading condition models the ash ponds with 2 ft of freeboard along the berm crest and assumes that the berm soils are fully saturated and a condition of steady state seepage occurs through the embankment. For this loading condition, effective stress soil parameters were used in the analysis.

Maximum Pool The analyses for “Maximum Pool” consider those given for “Steady State” but assume that the pond is completely full.

The maximum pool condition represents a more severe condition than an assumed steady state analysis with the pond level 2 ft below the top of the embankment. Provided the analyses meet the

relevant criteria for slope stability and seepage, a separate steady state analysis for normal operating conditions is not required.

Sudden Drawdown from Design Flood Stage This condition represents the situation when the water within the pond is drained at such a rapid rate that the saturated berm soils do not have time to drain. Consequently, excess pore water pressures result in the soil. We did not model this condition since it would pose no risk of environmental contamination, because the pond must be empty for this condition to occur.

SOIL PARAMETERS

Drained soil parameters (drained cohesion and drained friction angle) were selected for each soil stratum based on the laboratory and field test data collected during our study as well as correlations published by Stark and Hussain (2010)². The fully softened soil strength envelopes were compared to the stress path strength envelopes developed from the $\bar{C}U$ tests performed for this study. With the possible exception of the multi-stage $\bar{C}U$ test performed on a sandy clay sample harvested from Boring B-2 at 13 to 15 feet, all of the stress path strength envelopes developed from the $\bar{C}U$ tests exceeded the Stark and Hussain fully softened soil strength envelopes. We assumed that soil behavior was represented by the fully softened soil condition, and also evaluated Profile D using both the relevant fully softened soil strength envelope and the stress path strength envelope developed from the referenced $\bar{C}U$ test. We did not employ the residual strength soil properties since we found no evidence of pre-existing failure surfaces, and are unaware of any prior slope failures in the berm slopes. For purposes of our slope stability analyses, we have assigned the material properties presented in the following table.

Drained Fully Softened Shear Stresses from Equations Developed by Stark and Hussain (2010)

North and South SRH Ponds	Clay Fraction %	Assumed Liquid Limit	Normal Stress, psf				Equivalent Upper-Bound Soil Parameters	
			0	1,044	2,089	8,354	c (psf)	Phi (degrees)
Embankment Soil (CL)	47	42	0	647	1,158	4,075	186	25.0
Sandy Clay (CL)	52	52	0	561	972	3,281	202	20.2
Clayey Sand (ML)	36	33	0	669	1,197	4,240	183	25.9

² Stark, T.D. and M. Hussain, "Shear Strength in Pre-existing Landslides," *Journal of Geotechnical and Geoenvironmental Engineering*, ASCE, 136(7), July, 2010, pp. 957-962.

North and South Bottom Ash Ponds	Clay Fraction %	Assumed Liquid Limit	Normal Stress, psf				Equivalent Upper- Bound Soil Parameters	
			0	1,044	2,089	8,354	c (psf)	Phi (degrees)
Embankment Soil (CL)	45	35	0	664	1,188	4,202	184	25.7
Sandy Clay (CL)	61	51	0	563	976	3,298	202	20.3
Clayey Sand (ML)	43	33	0	669	1,197	4,240	183	25.9

Evaporation Pond	Clay Fraction %	Assumed Liquid Limit	Normal Stress, psf				Equivalent Upper- Bound Soil Parameters	
			0	1,044	2,089	8,354	c (psf)	Phi (degrees)
Embankment Soil (CL)	45	45	0	640	1,145	4,023	186	24.7
Sandy Clay (CL)	50	54	0	557	963	3,247	202	20.0
Clayey Sand (ML)	34	55	0	618	1,105	3,859	187	23.7

The tables obtained from Stark and Hussain can be used to estimate equivalent c-phi linear shear strength parameters that have been traditionally used in slope stability analyses. These values are also tabulated in the three tables presented above. Please note that the c-phi values tend to overestimate the available soil shear strength at low overburden pressures. The Stark and Hussain values correctly predict the likelihood of shallow surface sloughs for clay soils, but the calculated results for the deeper failures contemplated in this study should be essentially the same using either soil model.

Results of Analyses

The following table contains a summary of the results from our slope stability analyses for each loading condition and slope configuration. In general, the point where a potential slide surface was permitted to intersect was not allowed to occur within 3 ft of the relevant top of slope. This limitation was intended to reduce the occurrence of “non-critical” failure surfaces from resulting from the analyses. A graphical presentation of the most critical failure surface from our SLIDE iterations for each berm profile studied can be found at the end of this memorandum in Appendix C. The “a” series figures show the critical failure surface on the “dry side” of each berm, while the “b” series figures show the critical failure surface on the “pond side” of each berm.

Computed Factors of Safety for North and South SRH Ponds					
Slope Profile	End of Construction	Steady State on Pond Side	Steady State on Dry Side	Maximum Pool on Pond Side	Maximum Pool on Dry Side
J	N/A	> 2	> 2	> 2	> 2
K	N/A	> 2	> 2	> 2	> 2
L	N/A	> 2	> 2	> 2	> 2
M	N/A	> 2	1.7	> 2	1.6

Computed Factors of Safety for North and South Bottom Ash Ponds					
Slope Profile	End of Construction	Steady State on Pond Side	Steady State on Dry Side	Maximum Pool on Pond Side	Maximum Pool on Dry Side
E	N/A	> 2	> 2	> 2	> 2
F	N/A	> 2	> 2	> 2	> 2
G	N/A	1.8	1.3	> 2	1.4
H	N/A	> 2	> 2	> 2	> 2
I	N/A	1.8	1.6	> 2	1.5
N	N/A	1.9	1.6	> 2	1.6

Computed Factors of Safety for the Evaporation Pond					
Slope Profile	End of Construction	Steady State on Pond Side	Steady State on Dry Side	Maximum Pool on Pond Side	Maximum Pool on Dry Side
A	N/A	2	> 2	> 2	> 2
B	N/A	> 2	> 2	> 2	> 2
C	N/A	> 2	1.5	> 2	> 2
D	N/A	> 2	1.9	> 2	> 2

SEEPAGE ANALYSIS

We performed steady-state seepage analyses for each slope profile using the finite element groundwater module within SLIDE. Our seepage analyses were performed assuming that the soil properties observed in our borings exhibited a 5:1 ratio of permeability (horizontal:vertical) with the assumed permeability values presented in the following table.

Soil	Assumed Permeability, cm/second	
	Horizontal	Vertical
Clay	1×10^{-7}	2×10^{-8}
Sandy Clay	1×10^{-6}	2×10^{-7}
Clayey Sand	1×10^{-4}	2×10^{-5}

EARTHQUAKE ANALYSES

Each berm profile was also evaluated for earthquake conditions utilizing a design spectral acceleration of 0.098g. The assumed seismic force was calculated using the USGS web site calculator; in general, these analyses are considered to be very conservative since the nearest documented active fault is roughly 385 miles from the project site. A probabilistic assessment of the likelihood of the project site experiencing a magnitude 5 or larger earthquake within a 50 year period was also performed. This assessment indicated that the probability of occurrence was only 4 to 6 percent, which is considerably less than the 10 percent required by USEPA regulations. Graphical representations of these analyses are presented in Appendix D. The “a” series figures show the critical failure surface on the “dry side” of each berm, while the “b” series figures show the critical failure surface on the “pond side” of each berm.

Quasi-static analyses were performed, with soil behavior modeled using total stress soil strength values. The assumed values of shear strength used in our models consisted of both a cohesion intercept and angle of internal friction, with the cohesion intercept values chosen based on the unconfined compressive strength testing performed for this study as well as prior area experience. The strength values chosen are considered lower bound for the soils encountered at the project site.

The soil properties utilized for these analyses are presented in the following table:

Material	Unit Weight (pcf)	Cohesion (psf)	Phi (degrees)
Embankment Fill	120	350	20
Clayey Sand	120	400	20
Clayey Sand Below Water Table	57.6	400	20
Sandy Clay	120	500	20
Sandy Clay Below Water Table	57.6	500	20

Results of Quasi-Static (Seismic) Analyses

Global stability analyses were also performed for each slope analyzed for steady state conditions. The results of our analyses are summarized below and are graphically presented in Appendix D at the end of this report.

Computed Factors of Safety for North and South SRH Ponds					
Slope Profile	End of Construction	Steady State on Pond Side	Steady State on Dry Side	Maximum Pool on Pond Side	Maximum Pool on Dry Side
J	N/A	> 2	> 2	> 2	> 2
K	N/A	> 2	> 2	> 2	> 2
L	N/A	> 2	> 2	> 2	> 2
M	N/A	> 2	1.7	> 2	1.6

Computed Factors of Safety for North and South Bottom Ash Ponds					
Slope Profile	End of Construction	Steady State on Pond Side	Steady State on Dry Side	Maximum Pool on Pond Side	Maximum Pool on Dry Side
E	N/A	> 2	> 2	> 2	> 2
F	N/A	> 2	> 2	> 2	> 2
G	N/A	> 2	1.9	> 2	1.9
H	N/A	> 2	> 2	> 2	> 2
I	N/A	> 2	> 2	> 2	> 2
N	N/A	> 2	> 2	> 2	> 2

Computed Factors of Safety for the Evaporation Pond					
Slope Profile	End of Construction	Steady State on Pond Side	Steady State on Dry Side	Maximum Pool on Pond Side	Maximum Pool on Dry Side
A	N/A	> 2	> 2	> 2	> 2
B	N/A	> 2	> 2	> 2	> 2
C	N/A	> 2	1.5	> 2	> 2
D	N/A	> 2	1.9	> 2	> 2

RESULTS

In general, the global stability analyses for steady state conditions resulted in calculated factors of safety in excess of 2 for both long term and earthquake conditions. Three sections exhibited calculated factors of safety of less than 2, and one section (“G”) exhibited a calculated factor of safety of 1.2 for the “dry” slope. Review of Figure C-8a revealed that the critical failure surface for this analysis was relatively thin and did not appear to threaten the ash pond reservoir. A second analysis of this section was then performed, with the top of the assumed surfaces limited to intersecting the ground surface at the top of slope of the “wet” slope or farther from the “dry” slope. Surfaces in this portion of the berm would not threaten containment

of the ash pond's contents. The results of this analysis are presented on Figure C-8c, and indicate the calculated factor of safety for this analysis was 1.4.

Global stability analyses for the assumed earthquake conditions resulted in calculated factors of safety that exceeded 1.5 in the evaluated cases. These results indicate that pond failures due to seismic forces do not pose a significant threat to the ash ponds at this site.

CONCLUSIONS

The existing berms were constructed of lean sandy clays and/or clayey sands over competent sandy clays and clayey sands. Liquefaction is considered a very low risk issue at this site. The results of our seepage analyses indicate that no significant risk of an erosion or piping-type failure beneath the ash pond embankments exists. The results of our earthquake analyses indicate that no significant risk of embankment failure due to seismic forces exists at this site. Global stability analyses of steady state conditions indicate that acceptable calculated factors of safety were obtained for reasonable failure surfaces through the embankments at this site, even though the analyses were performed using fully softened soil strength envelopes that were lower than $\bar{C}\bar{U}$ tests indicate are available at the project site.

The end-of-construction condition was not evaluated due to the age of the ash ponds, and both rapid drawdown and erosion failures are considered to be of very low risk due to the embankment toe elevations (above EL 490 feet) with respect to the target pool elevation (EL 485 feet). We do not consider embankment seepage or underseepage to pose a significant risk to the berm based on both the long-term performance of the berms and the results of the seepage analyses, which was indirectly confirmed by the pH testing performed on all of the harvested soil samples. The results of our slope stability analyses indicate that all of the berm slopes meet or exceed both USEPA and USACE criteria for stability under steady state (long term) and seismic (earthquake) conditions.

* * * * *

The following appendices are attached and complete this report:

- | | |
|--------------------------|------------|
| Field Data | Appendix A |
| Laboratory Test Results | Appendix B |
| Slope Stability Analyses | Appendix C |
| Seismic Analyses | Appendix D |

APPENDIX A

FIELD DATA



RABA KISTNER CONSULTANTS
 Raba Kistner Consultants, Inc.
 12821 West Golden Lane
 San Antonio, Texas 78249
 P 210 :: 699 :: 9090
 F 210 :: 699 :: 6426
 www.rkci.com
 TBPE Firm Number 3257

SOURCE: 2011 Aerial Photograph Provided by the City of San Antonio (COSA)

BORING & MONITORING WELL LOCATION MAP

ASH POND BERMS - SPRUCE/DEELY GENERATION UNITS
 SAN ANTONIO, TEXAS

REVISIONS:		
No.	DATE	DESCRIPTION

PROJECT No.: ASA12-098-00

ISSUE DATE: 10/10/2012

DRAWN BY: CCL

CHECKED BY: RBW

REVIEWED BY: GLB

FIGURE

A-1

LOG OF BORING NO. B-1

Ash Pond Berms - Spruce/Deely Generation Units
San Antonio, Texas



DRILLING METHOD: Straight Flight Auger

LOCATION: N 29.32477; W 98.31464

DEPTH, FT	SYMBOL	SAMPLES	DESCRIPTION OF MATERIAL	BLOWS PER FT	UNIT DRY WEIGHT, pcf	SHEAR STRENGTH, TONS/FT ²			PLASTICITY INDEX	% -200	
						0.5	1.0	1.5			2.0
			SURFACE ELEVATION: 522 ft								
			BASE MATERIAL (6 in.)	11							
			FILL MATERIAL: SAND, Medium Dense, Tan								
			FILL MATERIAL: CLAY, Sandy, Firm, Reddish-Tan, with gray mottling	7						50	
5					106					16	
					110						
10			SAND, Clayey, Medium Dense to Very Dense, Tan to Gray		112					40	
15			-with a tan and gray clay seam from 13 to 15 ft	16						37	
			-switched to mud rotary at 15 ft								
20				22							
25				50/11"							
30				50/11"						43	
35				49							
				50/11"							
DEPTH DRILLED:			49.7 ft	DEPTH TO WATER:			N/A			PROJ. No.: ASA12-098-00	
DATE DRILLED:			10/15/2012	DATE MEASURED:			10/15/2012			FIGURE: A-2a	

NOTE: THESE LOGS SHOULD NOT BE USED SEPARATELY FROM THE PROJECT REPORT

LOG OF BORING NO. B-1
 Ash Pond Berms - Spruce/Deely Generation Units
 San Antonio, Texas



DRILLING METHOD: Straight Flight Auger

LOCATION: N 29.32477; W 98.31464

DEPTH, FT	SYMBOL	SAMPLES	DESCRIPTION OF MATERIAL	BLOWS PER FT	UNIT DRY WEIGHT, pcf	SHEAR STRENGTH, TONS/FT ²						PLASTICITY INDEX	% -200	
						0.5	1.0	1.5	2.0	2.5	3.0			3.5
			SURFACE ELEVATION: 522 ft											
			SAND, Clayey, Medium Dense to Very Dense, Tan to Gray (continued)											
45				50/9"										
50				50/8"										
55														
60														
65														
70														
75														

NOTE: THESE LOGS SHOULD NOT BE USED SEPARATELY FROM THE PROJECT REPORT

DEPTH DRILLED: 49.7 ft	DEPTH TO WATER: N/A	PROJ. No.: ASA12-098-00
DATE DRILLED: 10/15/2012	DATE MEASURED: 10/15/2012	FIGURE: A-2b

LOG OF BORING NO. B-2

Ash Pond Berms - Spruce/Deely Generation Units
San Antonio, Texas



DRILLING METHOD: Straight Flight Auger

LOCATION: N 29.32378; W 98.31541

DEPTH, FT	SYMBOL	SAMPLES	DESCRIPTION OF MATERIAL	BLOWS PER FT	UNIT DRY WEIGHT, pcf	SHEAR STRENGTH, TONS/FT ²				PLASTICITY INDEX	% -200
						0.5	1.0	1.5	2.0		
			SURFACE ELEVATION: 523 ft								
			FILL MATERIAL: CLAY, Sandy, Stiff, Brown	11							
			FILL MATERIAL: SAND, Clayey, Brown and Tan								
5										15	
			CLAY, Sandy, Very Stiff, Tan and Gray								
10											
15										36	
20			SAND, Clayey, Dense to Very Dense, Gray								
25				50/11"							24
30				50/10"							
35				38							
				50							

NOTE: THESE LOGS SHOULD NOT BE USED SEPARATELY FROM THE PROJECT REPORT

DEPTH DRILLED: 49.8 ft DATE DRILLED: 10/16/2012	DEPTH TO WATER: 40 ft DATE MEASURED: 10/16/2012	PROJ. No.: ASA12-098-00 FIGURE: A-3a
--	--	---

LOG OF BORING NO. B-2
 Ash Pond Berms - Spruce/Deely Generation Units
 San Antonio, Texas



DRILLING METHOD: Straight Flight Auger

LOCATION: N 29.32378; W 98.31541

DEPTH, FT	SYMBOL	SAMPLES	DESCRIPTION OF MATERIAL	BLOWS PER FT	UNIT DRY WEIGHT, pcf	SHEAR STRENGTH, TONS/FT ²							PLASTICITY INDEX	% -200	
						0.5	1.0	1.5	2.0	2.5	3.0	3.5			4.0
			SURFACE ELEVATION: 523 ft												
45			SAND, Clayey, Dense to Very Dense, Gray (continued) -DRILLER'S NOTE: WATER encountered at 40 ft	50/8"											
50				50/9"											
55															
60															
65															
70															
75															

DEPTH DRILLED: 49.8 ft	DEPTH TO WATER: 40 ft	PROJ. No.: ASA12-098-00
DATE DRILLED: 10/16/2012	DATE MEASURED: 10/16/2012	FIGURE: A-3b

NOTE: THESE LOGS SHOULD NOT BE USED SEPARATELY FROM THE PROJECT REPORT

LOG OF BORING NO. B-3

Ash Pond Berms - Spruce/Deely Generation Units
San Antonio, Texas



DRILLING METHOD: Straight Flight Auger

LOCATION: N 29.32401; W 98.31406

DEPTH, FT	SYMBOL	SAMPLES	DESCRIPTION OF MATERIAL	BLOWS PER FT	UNIT DRY WEIGHT, pcf	SHEAR STRENGTH, TONS/FT ²				PLASTICITY INDEX	% -200
						0.5	1.0	1.5	2.0		
SURFACE ELEVATION: 522 ft											
			FILL MATERIAL: SAND, Medium Dense, Brown, with gravel (road material)	24							
			FILL MATERIAL: SAND, Clayey, Medium Dense, Tan	12							
5				11						19	
				19							41
			CLAY, Sandy, Stiff to Very Stiff, Tan and Gray	14							
10				14							
				112						30	
15											
			SAND, Clayey, Dense to Very Dense, Tan to Gray	46							47
25											
				50							
30											
				50/11"							
35											
			-DRILLER'S NOTE: WATER encountered at 39 ft	50/11"							33
DEPTH DRILLED:		49.8 ft		DEPTH TO WATER:		40 ft		PROJ. No.:		ASA12-098-00	
DATE DRILLED:		10/15/2012		DATE MEASURED:		10/15/2012		FIGURE:		A-4a	

NOTE: THESE LOGS SHOULD NOT BE USED SEPARATELY FROM THE PROJECT REPORT

LOG OF BORING NO. B-3
 Ash Pond Berms - Spruce/Deely Generation Units
 San Antonio, Texas



DRILLING METHOD: Straight Flight Auger

LOCATION: N 29.32401; W 98.31406

DEPTH, FT	SYMBOL	SAMPLES	DESCRIPTION OF MATERIAL	BLOWS PER FT	UNIT DRY WEIGHT, pcf	SHEAR STRENGTH, TONS/FT ²						PLASTICITY INDEX	% -200	
						0.5	1.0	1.5	2.0	2.5	3.0			3.5
			SURFACE ELEVATION: 522 ft											
45			SAND, Clayey, Dense to Very Dense, Tan to Gray (continued) -with a tan and gray clay seam from 43 to 45 ft	38										
50				50/10"										
55														
60														
65														
70														
75														
DEPTH DRILLED: 49.8 ft			DEPTH TO WATER: 40 ft			PROJ. No.: ASA12-098-00								
DATE DRILLED: 10/15/2012			DATE MEASURED: 10/15/2012			FIGURE: A-4b								

NOTE: THESE LOGS SHOULD NOT BE USED SEPARATELY FROM THE PROJECT REPORT

LOG OF BORING NO. B-4

Ash Pond Berms - Spruce/Deely Generation Units
San Antonio, Texas



DRILLING METHOD: Straight Flight Auger

LOCATION: N 29.32322; W 98.31478

DEPTH, FT	SYMBOL	SAMPLES	DESCRIPTION OF MATERIAL	BLOWS PER FT	UNIT DRY WEIGHT, pcf	SHEAR STRENGTH, TONS/FT ²			PLASTICITY INDEX	% -200	
						0.5	1.0	1.5			2.0
SURFACE ELEVATION: 523 ft											
			FILL MATERIAL: CLAY, Sandy, Firm, Brown	7						25	
			FILL MATERIAL: CLAY, Sandy, Stiff to Very Stiff, Tan and Brown	5						54	
5				14						30	
				113							
				110							
10				26						27	
			SAND, Clayey, Dense, Brown								
15				49							
			CLAY, Very Stiff, Reddish-Tan	24							
25			SAND, Clayey, Dense to Very Dense, Tan and Gray, with intermittent clay seams								
				97						32	
30				50							
35				50/10"							
DEPTH DRILLED: 49.8 ft			DEPTH TO WATER: 42 ft			PROJ. No.: ASA12-098-00					
DATE DRILLED: 10/16/2012			DATE MEASURED: 10/16/2012			FIGURE: A-5a					

NOTE: THESE LOGS SHOULD NOT BE USED SEPARATELY FROM THE PROJECT REPORT

LOG OF BORING NO. B-4
 Ash Pond Berms - Spruce/Deely Generation Units
 San Antonio, Texas



DRILLING METHOD: Straight Flight Auger

LOCATION: N 29.32322; W 98.31478

DEPTH, FT	SYMBOL	SAMPLES	DESCRIPTION OF MATERIAL	BLOWS PER FT	UNIT DRY WEIGHT, pcf	SHEAR STRENGTH, TONS/FT ²						PLASTICITY INDEX	% -200
						0.5	1.0	1.5	2.0	2.5	3.0		
			SURFACE ELEVATION: 523 ft										
45		X	SAND, Clayey, Dense to Very Dense, Tan and Gray, with intermittent clay seams (continued) -DRILLER'S NOTE: WATER encountered at 42 ft	50									
50		X		50/9"									23
55													
60													
65													
70													
75													
DEPTH DRILLED: 49.8 ft			DEPTH TO WATER: 42 ft			PROJ. No.: ASA12-098-00							
DATE DRILLED: 10/16/2012			DATE MEASURED: 10/16/2012			FIGURE: A-5b							

NOTE: THESE LOGS SHOULD NOT BE USED SEPARATELY FROM THE PROJECT REPORT

LOG OF BORING NO. B-5

Ash Pond Berms - Spruce/Deely Generation Units
San Antonio, Texas



DRILLING METHOD: Straight Flight Auger

LOCATION: N 29.30947; W 98.31590

DEPTH, FT	SYMBOL	SAMPLES	DESCRIPTION OF MATERIAL	BLOWS PER FT	UNIT DRY WEIGHT, pcf	SHEAR STRENGTH, TONS/FT ²				PLASTICITY INDEX	% -200				
						0.5	1.0	1.5	2.0			2.5	3.0	3.5	4.0
			SURFACE ELEVATION: 501 ft			10	20	30	40	50	60	70	80		
5			FILL MATERIAL: SAND, Clayey, Medium Dense, Tan	17											
				21											
				24											
				20										19	
															46
			SAND, Clayey, Medium Dense to Very Dense, Gray	33											46
				50/10"											
				50/9"											
			-with a clay seam from 28-1/2 to 30 ft	24											
				50/7"											31
				50/8"											

NOTE: THESE LOGS SHOULD NOT BE USED SEPARATELY FROM THE PROJECT REPORT

DEPTH DRILLED: 39.7 ft	DEPTH TO WATER: 14 ft	PROJ. No.: ASA12-098-00
DATE DRILLED: 10/17/2012	DATE MEASURED: 10/17/2012	FIGURE: A-6

LOG OF BORING NO. B-6

Ash Pond Berms - Spruce/Deely Generation Units
San Antonio, Texas



DRILLING METHOD: Straight Flight Auger

LOCATION: N 29.30837; W 98.31790

DEPTH, FT	SYMBOL	SAMPLES	DESCRIPTION OF MATERIAL	BLOWS PER FT	UNIT DRY WEIGHT, pcf	SHEAR STRENGTH, TONS/FT ²			PLASTICITY INDEX	% -200
						0.5	1.0	1.5		
SURFACE ELEVATION: 500 ft										
5			FILL MATERIAL: CLAY, Sandy, Stiff to Very Stiff, Tan	15						
				14					15	
				24						50
				19						
				21						
10			GRAVEL, Tan							
			CLAY, Sandy, Firm to Hard, Tan and Gray							
				7					32	
			-DRILLER'S NOTE: WATER encountered at 14 ft							
				50/11"						51
				50/10"						
				38					18	
				50/8"						
			SAND, Clayey, Very Dense, Gray							
				50/10"						29

NOTE: THESE LOGS SHOULD NOT BE USED SEPARATELY FROM THE PROJECT REPORT

DEPTH DRILLED: 39.8 ft DATE DRILLED: 10/18/2012	DEPTH TO WATER: 14 ft DATE MEASURED: 10/18/2012	PROJ. No.: ASA12-098-00 FIGURE: A-7
--	--	--

LOG OF BORING NO. B-7

Ash Pond Berms - Spruce/Deely Generation Units
San Antonio, Texas



DRILLING METHOD: Straight Flight Auger

LOCATION: N 29.30899; W 98.31660

DEPTH, FT	SYMBOL	SAMPLES	DESCRIPTION OF MATERIAL	BLOWS PER FT	UNIT DRY WEIGHT, pcf	SHEAR STRENGTH, TONS/FT ²			PLASTICITY INDEX	% -200
						0.5	1.0	1.5		
SURFACE ELEVATION: 500 ft										
			FILL MATERIAL: SAND, Clayey, Medium Dense, Brown	10						
			FILL MATERIAL: CLAY, Sandy, Very Stiff, Tan and Gray	29						
5				22					19	
				115						
10									17	
-DRILLER'S NOTE: WATER encountered at 11 ft										
			SAND, Clayey, Very Dense, Tan and Gray	50/9"						47
15										
				50/11"						
20			CLAY, Sandy, Hard, Tan and Gray							
				50/9"					18	
25										
				47						
30										
35										

NOTE: THESE LOGS SHOULD NOT BE USED SEPARATELY FROM THE PROJECT REPORT

DEPTH DRILLED: 30.0 ft DATE DRILLED: 10/16/2012	DEPTH TO WATER: 11 ft DATE MEASURED: 10/16/2012	PROJ. No.: ASA12-098-00 FIGURE: A-8
--	--	--

LOG OF BORING NO. B-8

Ash Pond Berms - Spruce/Deely Generation Units
San Antonio, Texas



DRILLING METHOD: Straight Flight Auger

LOCATION: N 29.30884; W 98.31510

DEPTH, FT	SYMBOL	SAMPLES	DESCRIPTION OF MATERIAL	BLOWS PER FT	UNIT DRY WEIGHT, pcf	SHEAR STRENGTH, TONS/FT ²			PLASTICITY INDEX	% -200
						0.5	1.0	1.5		
SURFACE ELEVATION: 501 ft										
5			FILL MATERIAL: SAND, Clayey, Loose to Medium Dense, Brown and Tan	25						
7			-with a tan and gray clay seam from 6 to 8 ft	14						NP
11				7						39
11				113						
15			CLAY, Sandy, Very Stiff, Tan and Gray							
15				111						
20			SAND, Clayey, Medium Dense to Dense, Tan and Gray -DRILLER'S NOTE: WATER encountered at 16 ft	25						47
25				10						18
30				25						
35			-with a tan and gray clay seam from 33 to 35 ft	38						52
50/8"										9

NOTE: THESE LOGS SHOULD NOT BE USED SEPARATELY FROM THE PROJECT REPORT

DEPTH DRILLED: 39.7 ft	DEPTH TO WATER: 16 ft	PROJ. No.: ASA12-098-00
DATE DRILLED: 10/19/2012	DATE MEASURED: 10/19/2012	FIGURE: A-9

LOG OF BORING NO. B-9

Ash Pond Berms - Spruce/Deely Generation Units
San Antonio, Texas



DRILLING METHOD: Straight Flight Auger

LOCATION: N 29.30802; W 98.31601

DEPTH, FT	SYMBOL	SAMPLES	DESCRIPTION OF MATERIAL	BLOWS PER FT	UNIT DRY WEIGHT, pcf	SHEAR STRENGTH, TONS/FT ²				PLASTICITY INDEX	% -200
						0.5	1.0	1.5	2.0		
SURFACE ELEVATION: 499 ft											
			FILL MATERIAL: SAND, Medium Dense, Brown and Tan	11							
			FILL MATERIAL: CLAY, Stiff to Very Stiff, Tan	14							
5				16						21	
				11							
10			SAND, Clayey, Loose to Very Dense, Tan and Gray								
				9							49
			-DRILLER'S NOTE: WATER encountered at 16 ft								
				50/11"							
				ref/1"							
			CLAY, Sandy, Hard, Tan and Gray	50/11"							62
30											
35											

NOTE: THESE LOGS SHOULD NOT BE USED SEPARATELY FROM THE PROJECT REPORT

DEPTH DRILLED: 29.9 ft	DEPTH TO WATER: 16 ft	PROJ. No.: ASA12-098-00
DATE DRILLED: 10/17/2012	DATE MEASURED: 10/17/2012	FIGURE: A-10

LOG OF BORING NO. B-10

Ash Pond Berms - Spruce/Deely Generation Units
San Antonio, Texas



DRILLING METHOD: Straight Flight Auger

LOCATION: N 29.30769; W 98.31855

DEPTH, FT	SYMBOL	SAMPLES	DESCRIPTION OF MATERIAL	BLOWS PER FT	UNIT DRY WEIGHT, pcf	SHEAR STRENGTH, TONS/FT ²				PLASTICITY INDEX	% -200	
						0.5	1.0	1.5	2.0			2.5
SURFACE ELEVATION: 496 ft												
5			FILL MATERIAL: CLAY, Sandy, Very Stiff, Tan	16								
				16								16
				19								
				24								
10				19								27
			SAND, Clayey, Medum Dense to Very Dense, Tan and Gray, with intermittent clay seams									
15					97							41
			-DRILLER'S NOTE: WATER encountered at 17 ft									
20				38								
25				17								
30				ref/1"								
35				50/9"								42
			CLAY, Very Stiff, Dark Gray									
				26								

NOTE: THESE LOGS SHOULD NOT BE USED SEPARATELY FROM THE PROJECT REPORT

DEPTH DRILLED: 40.0 ft DATE DRILLED: 10/17/2012	DEPTH TO WATER: 17 ft DATE MEASURED: 10/17/2012	PROJ. No.: ASA12-098-00 FIGURE: A-11
--	--	---

LOG OF BORING NO. B-11

Ash Pond Berms - Spruce/Deely Generation Units
San Antonio, Texas



DRILLING METHOD: Straight Flight Auger

LOCATION: N 29.30737; W 98.31744

DEPTH, FT	SYMBOL	SAMPLES	DESCRIPTION OF MATERIAL	BLOWS PER FT	UNIT DRY WEIGHT, pcf	SHEAR STRENGTH, TONS/FT ²				PLASTICITY INDEX	% -200	
						0.5	1.0	1.5	2.0			2.5
SURFACE ELEVATION: 496 ft												
			FILL MATERIAL: CLAY, Sandy, Stiff to Very Stiff, Tan to Brown	15							16	
5			-with a tan sand seam from 4 to 6 ft	11								
				12								49
				18								
10												
			SAND, Clayey, Medium Dense to Dense, Tan and Gray, with intermittent clay seams	18								
15			-DRILLER'S NOTE: WATER encountered at 16 ft									
				18								
20												
				49								34
25												
				42								
30												
35												

NOTE: THESE LOGS SHOULD NOT BE USED SEPARATELY FROM THE PROJECT REPORT

DEPTH DRILLED: 30.0 ft	DEPTH TO WATER: 16 ft	PROJ. No.: ASA12-098-00
DATE DRILLED: 10/18/2012	DATE MEASURED: 10/18/2012	FIGURE: A-12

LOG OF BORING NO. B-12

Ash Pond Berms - Spruce/Deely Generation Units
San Antonio, Texas



DRILLING METHOD: Straight Flight Auger

LOCATION: N 29.30757; W 98.31509

DEPTH, FT	SYMBOL	SAMPLES	DESCRIPTION OF MATERIAL	BLOWS PER FT	UNIT DRY WEIGHT, pcf	SHEAR STRENGTH, TONS/FT ²				PLASTICITY INDEX	% -200
						0.5	1.0	1.5	2.0		
						PLASTIC LIMIT WATER CONTENT LIQUID LIMIT X-----X •-----• X-----X 10 20 30 40 50 60 70 80					
SURFACE ELEVATION: 500 ft											
			FILL MATERIAL: SAND, Clayey, Loose to Medium Dense, Brown, with gravel	23							46
			CLAY, Sandy, Firm to Hard, Tan to Brown	6							
5				8							18
				27							21
10											
			-DRILLER'S NOTE: WATER encountered at 16 ft	18							
15											
				24							
20											
				50/11"							51
25			SANDSTONE, Hard, Gray								
			SAND, Clayey, Medium Dense, Tan and Gray								
30				11							
35											

NOTE: THESE LOGS SHOULD NOT BE USED SEPARATELY FROM THE PROJECT REPORT

DEPTH DRILLED: 30.0 ft DATE DRILLED: 10/17/2012	DEPTH TO WATER: 16 ft DATE MEASURED: 10/17/2012	PROJ. No.: ASA12-098-00 FIGURE: A-13
--	--	---

LOG OF BORING NO. B-13
 Ash Pond Berms - Spruce/Deely Generation Units
 San Antonio, Texas



DRILLING METHOD: Straight Flight Auger

LOCATION: N 29.30715; W 98.31792

DEPTH, FT	SYMBOL	SAMPLES	DESCRIPTION OF MATERIAL	BLOWS PER FT	UNIT DRY WEIGHT, pcf	SHEAR STRENGTH, TONS/FT ²				PLASTICITY INDEX	% -200	
						0.5	1.0	1.5	2.0			2.5
SURFACE ELEVATION: 496 ft												
5			FILL MATERIAL: CLAY, Sandy, Very Stiff to Hard, Tan to Brown -with a tan sand seam from 4 to 6 ft	23								
				27							16	
				34								43
				16								
10												
15			CLAY, Sandy, Very Stiff to Hard, Tan and Gray -DRILLER'S NOTE: WATER encountered at 16 ft	18								
20				19								53
25				41								
30				34							33	
35				41								
				39								
DEPTH DRILLED: 40.0 ft			DEPTH TO WATER: 16 ft			PROJ. No.: ASA12-098-00						
DATE DRILLED: 10/18/2012			DATE MEASURED: 10/18/2012			FIGURE: A-14						

NOTE: THESE LOGS SHOULD NOT BE USED SEPARATELY FROM THE PROJECT REPORT

LOG OF BORING NO. B-14

Ash Pond Berms - Spruce/Deely Generation Units
San Antonio, Texas



DRILLING METHOD: Straight Flight Auger

LOCATION: N 29.30684; W 98.31590

DEPTH, FT	SYMBOL	SAMPLES	DESCRIPTION OF MATERIAL	BLOWS PER FT	UNIT DRY WEIGHT, pcf	SHEAR STRENGTH, TONS/FT ²			PLASTICITY INDEX	% -200
						0.5	1.0	1.5		
SURFACE ELEVATION: 501 ft										
			FILL MATERIAL: SAND, Clayey, Loose to Dense, Brown and Tan	9						
				30						46
5			CLAY, Sandy, Very Stiff to Hard, Tan to Tan and Gray	18						27
				118						
				117						
			-DRILLER'S NOTE: WATER encountered at 16 ft							
				15						36
				ref/3"						
				32						72
			SAND, Clayey, Very Dense, Tan and Gray	50/9"						
				50/8"						
DEPTH DRILLED:		39.7 ft		DEPTH TO WATER:		16 ft		PROJ. No.:		ASA12-098-00
DATE DRILLED:		10/19/2012		DATE MEASURED:		10/19/2012		FIGURE:		A-15

NOTE: THESE LOGS SHOULD NOT BE USED SEPARATELY FROM THE PROJECT REPORT

KEY TO TERMS AND SYMBOLS

MATERIAL TYPES

SOIL TERMS

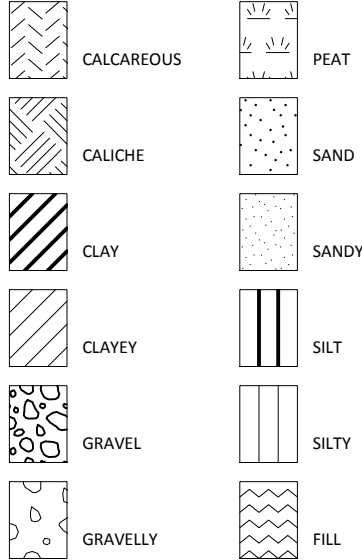

ROCK TERMS

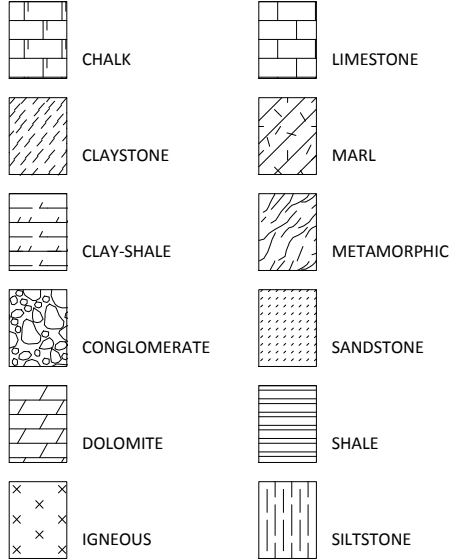

OTHER

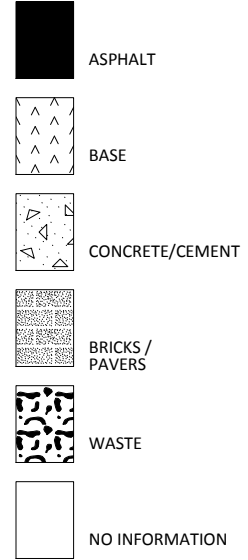

WELL CONSTRUCTION AND PLUGGING MATERIALS

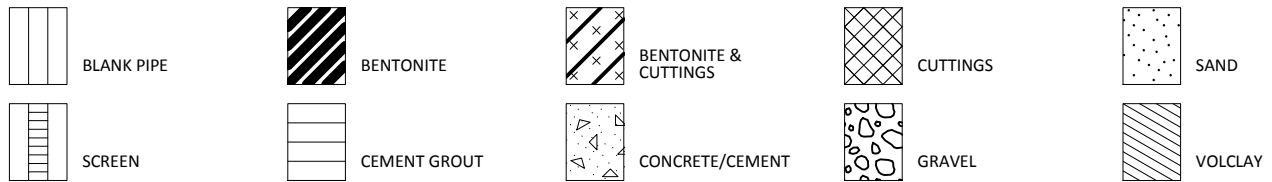

SAMPLE TYPES

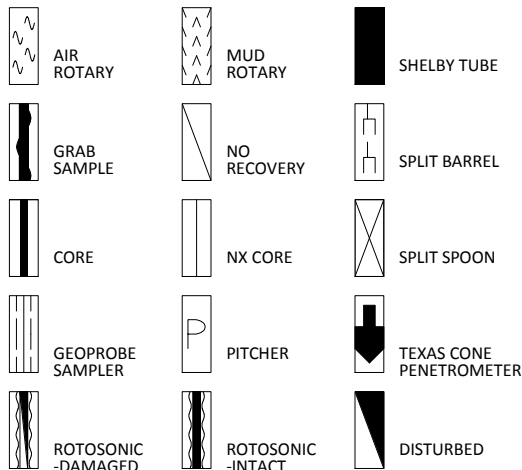

STRENGTH TEST TYPES

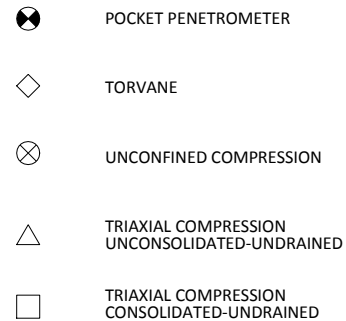

NOTE: VALUES SYMBOLIZED ON BORING LOGS REPRESENT SHEAR STRENGTHS UNLESS OTHERWISE NOTED

PROJECT NO. ASA12-098-00

KEY TO TERMS AND SYMBOLS (CONT'D)

TERMINOLOGY

Terms used in this report to describe soils with regard to their consistency or conditions are in general accordance with the discussion presented in Article 45 of SOILS MECHANICS IN ENGINEERING PRACTICE, Terzaghi and Peck, John Wiley & Sons, Inc., 1967, using the most reliable information available from the field and laboratory investigations. Terms used for describing soils according to their texture or grain size distribution are in accordance with the UNIFIED SOIL CLASSIFICATION SYSTEM, as described in American Society for Testing and Materials D2487-06 and D2488-00, Volume 04.08, Soil and Rock; Dimension Stone; Geosynthetics; 2005.

The depths shown on the boring logs are not exact, and have been estimated to the nearest half-foot. Depth measurements may be presented in a manner that implies greater precision in depth measurement, i.e 6.71 meters. The reader should understand and interpret this information only within the stated half-foot tolerance on depth measurements.

RELATIVE DENSITY

COHESIVE STRENGTH

PLASTICITY

<u>Penetration Resistance Blows per ft</u>	<u>Relative Density</u>	<u>Resistance Blows per ft</u>	<u>Consistency</u>	<u>Cohesion TSF</u>	<u>Plasticity Index</u>	<u>Degree of Plasticity</u>
0 - 4	Very Loose	0 - 2	Very Soft	0 - 0.125	0 - 5	None
4 - 10	Loose	2 - 4	Soft	0.125 - 0.25	5 - 10	Low
10 - 30	Medium Dense	4 - 8	Firm	0.25 - 0.5	10 - 20	Moderate
30 - 50	Dense	8 - 15	Stiff	0.5 - 1.0	20 - 40	Plastic
> 50	Very Dense	15 - 30	Very Stiff	1.0 - 2.0	> 40	Highly Plastic
		> 30	Hard	> 2.0		

ABBREVIATIONS

B = Benzene	Qam, Qas, Qal = Quaternary Alluvium	Kef = Eagle Ford Shale
T = Toluene	Qat = Low Terrace Deposits	Kbu = Buda Limestone
E = Ethylbenzene	Qbc = Beaumont Formation	Kdr = Del Rio Clay
X = Total Xylenes	Qt = Fluvial Terrace Deposits	Kft = Fort Terrett Member
BTEX = Total BTEX	Qao = Seymour Formation	Kgt = Georgetown Formation
TPH = Total Petroleum Hydrocarbons	Qle = Leona Formation	Kep = Person Formation
ND = Not Detected	Q-Tu = Uvalde Gravel	Kek = Kainer Formation
NA = Not Analyzed	Ewi = Wilcox Formation	Kes = Escondido Formation
NR = Not Recorded/No Recovery	Emi = Midway Group	Kew = Walnut Formation
OVA = Organic Vapor Analyzer	Mc = Catahoula Formation	Kgr = Glen Rose Formation
ppm = Parts Per Million	EI = Laredo Formation	Kgru = Upper Glen Rose Formation
	Kknm = Navarro Group and Marlbrook Marl	Kgrl = Lower Glen Rose Formation
	Kpg = Pecan Gap Chalk	Kh = Hensell Sand
	Kau = Austin Chalk	

PROJECT NO. ASA12-098-00

KEY TO TERMS AND SYMBOLS (CONT'D)

TERMINOLOGY

SOIL STRUCTURE

Slickensided	Having planes of weakness that appear slick and glossy.
Fissured	Containing shrinkage or relief cracks, often filled with fine sand or silt; usually more or less vertical.
Pocket	Inclusion of material of different texture that is smaller than the diameter of the sample.
Parting	Inclusion less than 1/8 inch thick extending through the sample.
Seam	Inclusion 1/8 inch to 3 inches thick extending through the sample.
Layer	Inclusion greater than 3 inches thick extending through the sample.
Laminated	Soil sample composed of alternating partings or seams of different soil type.
Interlayered	Soil sample composed of alternating layers of different soil type.
Intermixed	Soil sample composed of pockets of different soil type and layered or laminated structure is not evident.
Calcareous	Having appreciable quantities of carbonate.
Carbonate	Having more than 50% carbonate content.

SAMPLING METHODS

RELATIVELY UNDISTURBED SAMPLING

Cohesive soil samples are to be collected using three-inch thin-walled tubes in general accordance with the Standard Practice for Thin-Walled Tube Sampling of Soils (ASTM D1587) and granular soil samples are to be collected using two-inch split-barrel samplers in general accordance with the Standard Method for Penetration Test and Split-Barrel Sampling of Soils (ASTM D1586). Cohesive soil samples may be extruded on-site when appropriate handling and storage techniques maintain sample integrity and moisture content.

STANDARD PENETRATION TEST (SPT)

A 2-in.-OD, 1-3/8-in.-ID split spoon sampler is driven 1.5 ft into undisturbed soil with a 140-pound hammer free falling 30 in. After the sampler is seated 6 in. into undisturbed soil, the number of blows required to drive the sampler the last 12 in. is the Standard Penetration Resistance or "N" value, which is recorded as blows per foot as described below.

SPLIT-BARREL SAMPLER DRIVING RECORD

<u>Blows Per Foot</u>	<u>Description</u>
25	25 blows drove sampler 12 inches, after initial 6 inches of seating.
50/7"	50 blows drove sampler 7 inches, after initial 6 inches of seating.
Ref/3"	50 blows drove sampler 3 inches during initial 6-inch seating interval.

NOTE: To avoid damage to sampling tools, driving is limited to 50 blows during or after seating interval.

APPENDIX B

LABORATORY TEST RESULTS

RESULTS OF SOIL SAMPLE ANALYSES

PROJECT NAME: Ash Pond Berms - Spruce/Deely Generation Units
San Antonio, Texas

FILE NAME: ASA12-098-00.GPJ

11/20/2012

Boring No.	Sample Depth (ft)	Blows per ft	Water Content (%)	Liquid Limit	Plastic Limit	Plasticity Index	USCS	Dry Unit Weight (pcf)	% -200 Sieve	Shear Strength (tsf)	Strength Test
B-1	0.0 to 1.5	11	15								
	2.5 to 4.0	7	23								
	4.0 to 6.0		18	31	15	16	CL	106	50	0.27	UC
	6.0 to 8.0		15					110		1.09	UC
	8.0 to 10.0		13					112	40	0.39	UC
	13.5 to 15.0	16	21	55	18	37	CH				
	18.5 to 20.0	22	18								
	23.5 to 24.9	50/11"	14								
	28.5 to 29.9	50/11"	11						43		
	33.5 to 35.0	49	20								
	38.5 to 39.9	50/11"	20								
	43.5 to 44.8	50/9"	19								
	48.5 to 49.7	50/8"	19								
B-2	0.0 to 1.5	11	18								
	2.0 to 4.0		11					119	38	2.59	UC
	4.0 to 6.0		17	33	18	15	CL	104		0.79	UC
	6.0 to 8.0		19					102		0.28	UC
	8.0 to 10.0		17					110		0.98	UC
	13.0 to 15.0		18	54	18	36	CH			2.00	PP
	18.0 to 20.0		13					101		0.65	UC
	23.5 to 24.9	50/11"	12						24		
	28.5 to 29.8	50/10"	20								
	33.5 to 35.0	38	12								
	38.5 to 40.0	50	20								
	43.5 to 44.7	50/8"	18								
	48.5 to 49.8	50/9"	20								
B-3	0.0 to 1.5	24	13								
	2.5 to 4.0	12	15								
	4.5 to 6.0	11	17	34	15	19	CL				
	6.5 to 8.0	19	17						41		
	8.5 to 10.0	14	17								
	13.0 to 15.0		18	42	12	30	CL	112		0.73	UC
	18.0 to 20.0		15							2.00	PP
	23.5 to 25.0	46	11						47		
	28.5 to 30.0	50									
	33.5 to 34.9	50/11"	13								
	38.5 to 39.9	50/11"	18						33		
	43.5 to 45.0	38	27								
	48.5 to 49.8	50/10"	22								

PP = Pocket Penetrometer TV = Torvane UC = Unconfined Compression FV = Field Vane UU = Unconsolidated Undrained Triaxial
CU = Consolidated Undrained Triaxial

PROJECT NO. ASA12-098-00

RABAKISTNER

FIGURE B-1a

RESULTS OF SOIL SAMPLE ANALYSES

PROJECT NAME: Ash Pond Berms - Spruce/Deely Generation Units
San Antonio, Texas

FILE NAME: ASA12-098-00.GPJ

11/20/2012

Boring No.	Sample Depth (ft)	Blows per ft	Water Content (%)	Liquid Limit	Plastic Limit	Plasticity Index	USCS	Dry Unit Weight (pcf)	% -200 Sieve	Shear Strength (tsf)	Strength Test
B-4	0.0 to 1.5	7	16	40	15	25	CL				
	2.5 to 4.0	5	14						54		
	4.5 to 6.0	14	12	45	15	30	CL				
	6.0 to 8.0		14					113		1.96	UC
	8.0 to 10.0		11					110		0.71	UC
	13.5 to 15.0	26	18	41	14	27	CL				
	18.5 to 20.0	49	10								
	23.5 to 25.0	24	15								
	28.0 to 30.0		13					97	32	1.50	PP
	33.5 to 35.0	50	14								
	38.5 to 39.8	50/10"	25								
	43.5 to 45.0	50	24								
	48.5 to 49.8	50/9"	19						23		
B-5	0.0 to 1.5	17	13								
	2.5 to 4.0	21	14								
	4.5 to 6.0	24	13								
	6.5 to 8.0	20	16	32	13	19	CL				
	8.0 to 10.0		14						46	2.00	PP
	13.5 to 15.0	33	26						46		
	18.5 to 19.8	50/10"	24								
	23.5 to 24.8	50/9"	22								
	28.5 to 30.0	24	21								
	33.5 to 34.6	50/7"	24						31		
B-6	0.0 to 1.5	15	11								
	2.5 to 4.0	14	16	33	18	15	CL				
	4.5 to 6.0	24	13						50		
	6.5 to 8.0	19	15								
	8.5 to 10.0	21	17								
	13.5 to 15.0	7	24	49	17	32	CL				
	18.5 to 19.9	50/11"	25						51		
	23.5 to 24.8	50/10"	23								
	28.5 to 30.0	38	21	38	20	18	CL				
	33.5 to 34.7	50/8"	23								
B-7	0.0 to 1.5	10	19								
	2.5 to 4.0	29	7								
	4.5 to 6.0	22	14	34	15	19	CL				
	6.0 to 8.0		16								
								115		1.37	UC

PP = Pocket Penetrometer TV = Torvane UC = Unconfined Compression FV = Field Vane UU = Unconsolidated Undrained Triaxial
CU = Consolidated Undrained Triaxial

PROJECT NO. ASA12-098-00

RESULTS OF SOIL SAMPLE ANALYSES

PROJECT NAME: Ash Pond Berms - Spruce/Deely Generation Units
San Antonio, Texas

FILE NAME: ASA12-098-00.GPJ

11/20/2012

Boring No.	Sample Depth (ft)	Blows per ft	Water Content (%)	Liquid Limit	Plastic Limit	Plasticity Index	USCS	Dry Unit Weight (pcf)	% -200 Sieve	Shear Strength (tsf)	Strength Test
B-7	8.0 to 10.0		14	32	15	17	CL			2.00	PP
	13.5 to 14.8	50/9"	25						47		
	18.5 to 19.9	50/11"	23								
	23.5 to 24.8	50/9"	19	35	17	18	CL				
	28.5 to 30.0	47	19								
B-8	0.0 to 1.5	25	16								
	2.5 to 4.0	14	39			NP					
	4.5 to 6.0	7	16						39		
	6.0 to 8.0		15					113		0.78	UC
	8.0 to 10.0									2.00	PP
	13.0 to 15.0		18					111		0.39	UC
	18.5 to 20.0	25	23						47		
	23.5 to 25.0	10	20	33	15	18	CL				
	28.5 to 30.0	25	22								
	33.5 to 35.0	38	19						52		
B-9	38.5 to 39.7	50/8"	24	29	20	9	CL				
	0.0 to 1.5	11	13								
	2.5 to 4.0	14	16								
	4.5 to 6.0	16	15	35	14	21	CL				
	6.5 to 8.0	11	20								
	8.0 to 10.0		21							1.50	PP
	13.5 to 15.0	9	23						49		
	18.5 to 19.9	50/11"	24								
B-10	23.5 to 23.6	ref/1"	26								
	28.5 to 29.9	50/11"	20						62		
	0.0 to 1.5	16	13								
	2.5 to 4.0	16	16	32	16	16	CL				
	4.5 to 6.0	19	14								
	6.5 to 8.0	24	18								
	8.5 to 10.0	19	15	42	15	27	CL				
	13.0 to 15.0		22					97	41	0.23	UC
	18.5 to 20.0	38	26								
	23.5 to 25.0	17	29								
B-11	28.5 to 28.6	ref/1"	6								
	33.5 to 34.8	50/9"	19						42		
	38.5 to 40.0	26	21								
	0.0 to 1.5	15	14	32	16	16	CL				
	2.5 to 4.0	11	15								
	4.5 to 6.0	12	17					49			

PP = Pocket Penetrometer TV = Torvane UC = Unconfined Compression FV = Field Vane UU = Unconsolidated Undrained Triaxial
CU = Consolidated Undrained Triaxial

PROJECT NO. ASA12-098-00

RABAKISTNER

FIGURE B-1c

RESULTS OF SOIL SAMPLE ANALYSES

PROJECT NAME: Ash Pond Berms - Spruce/Deely Generation Units
San Antonio, Texas

FILE NAME: ASA12-098-00.GPJ

11/20/2012

Boring No.	Sample Depth (ft)	Blows per ft	Water Content (%)	Liquid Limit	Plastic Limit	Plasticity Index	USCS	Dry Unit Weight (pcf)	% -200 Sieve	Shear Strength (tsf)	Strength Test
B-11	6.5 to 8.0	18	13								
	8.0 to 10.0									2.00	PP
	13.5 to 15.0	18	18								
	18.5 to 20.0	18	26								
	23.5 to 25.0	49	23						34		
B-12	28.5 to 30.0	42	24								
	0.0 to 1.5	23	28						46		
	2.5 to 4.0	6	38								
	4.5 to 6.0	8	16	32	14	18	CL				
	6.5 to 8.0	27	14								
	8.0 to 10.0		15	34	13	21	CL			2.00	PP
	13.5 to 15.0	18	18								
B-13	18.5 to 20.0	24	28								
	23.5 to 24.9	50/11"	23						51		
	28.5 to 30.0	11	28								
	0.0 to 1.5	23	13								
	2.5 to 4.0	27	14	33	17	16	CL				
	4.5 to 6.0	34	14						43		
	6.5 to 8.0	16	15								
	8.0 to 10.0									2.00	PP
	13.5 to 15.0	18	19								
	18.5 to 20.0	19	24						53		
B-14	23.5 to 25.0	41	25								
	28.5 to 30.0	34	26	52	19	33	CH				
	33.5 to 35.0	41	21								
	38.5 to 40.0	39	20								
	0.0 to 1.5	9	9								
	2.5 to 4.0	30	8						46		
	4.5 to 6.0	18	13	41	14	27	CL				
	6.0 to 8.0		14					118		1.10	UC
	8.0 to 10.0		15					117		1.15	UC
	13.0 to 15.0									1.25	PP
B-14	18.5 to 20.0	15	19	51	15	36	CH				
	23.5 to 23.8	ref/3"	5								
	28.5 to 30.0	32	25						72		
	33.5 to 34.8	50/9"	19								
	38.5 to 39.7	50/8"	18								

PP = Pocket Penetrometer TV = Torvane UC = Unconfined Compression FV = Field Vane UU = Unconsolidated Undrained Triaxial
CU = Consolidated Undrained Triaxial

PROJECT NO. ASA12-098-00

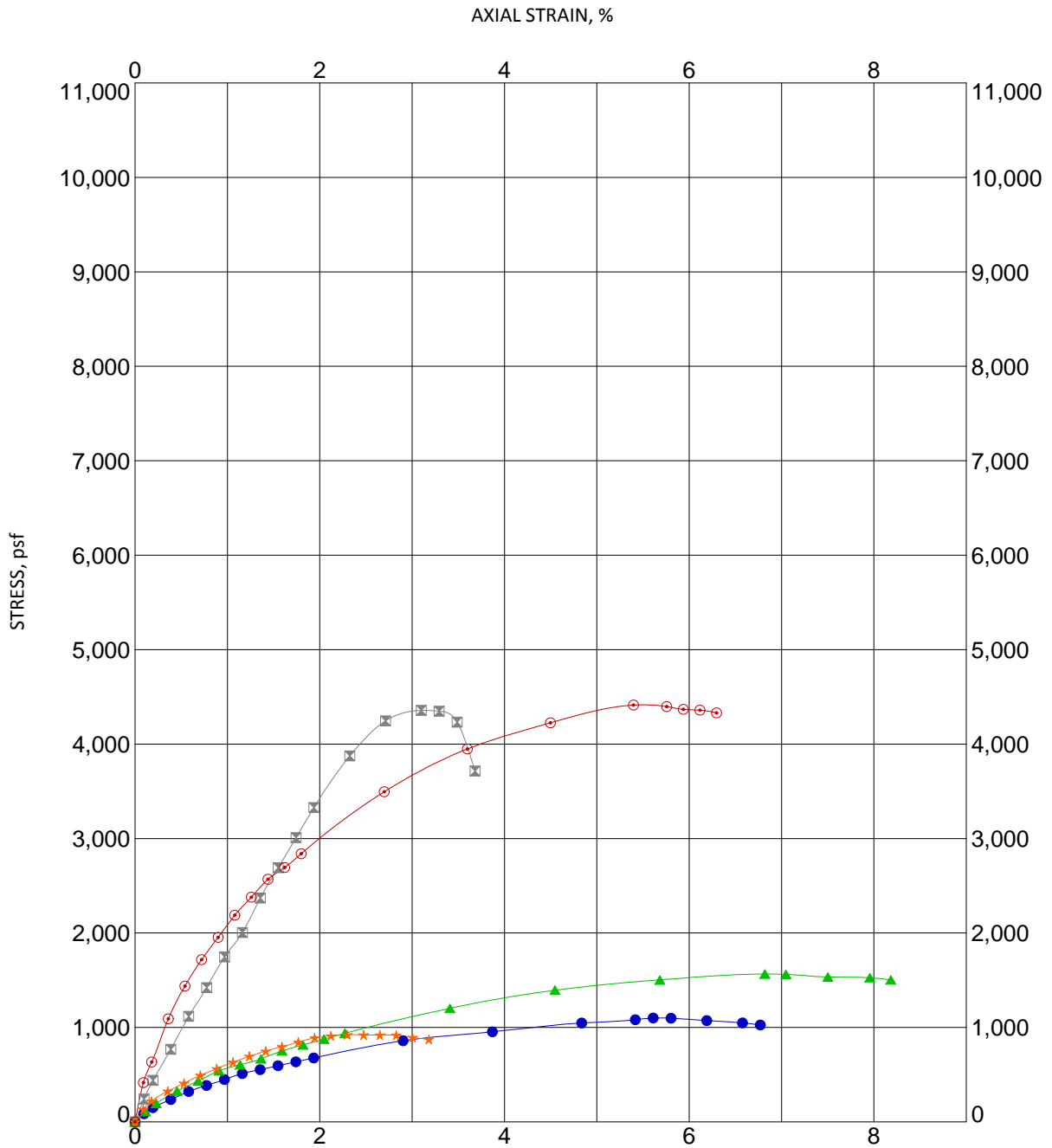

FIGURE B-2

Specimen Identification	Classification	Shear Str. (tsf)	Failure Strain (%)	PI	Dry Unit Weight (pcf)	w (%)
● B-1 4 ft		0.3	5.6	16	106.0	17.7
⊠ B-1 6 ft		1.1	3.1		109.9	15.4
▲ B-1 8 ft		0.4	6.8		111.8	13.2
★ B-10 13 ft		0.2	2.3		97.4	24.5
⊙ B-14 6 ft		1.1	5.4		117.9	13.6

R-K UNCONFINED COMPRESSION ASA12-098-00.GPJ RKCI.GDT 11/20/12



12821 W. Golden Lane
 San Antonio, Texas 78249
 (210) 699-9090
 (210) 699-6426 fax
 www.rkci.com

UNCONFINED COMPRESSION

Ash Pond Berms - Spruce/Deely Generation Units
 San Antonio, Texas

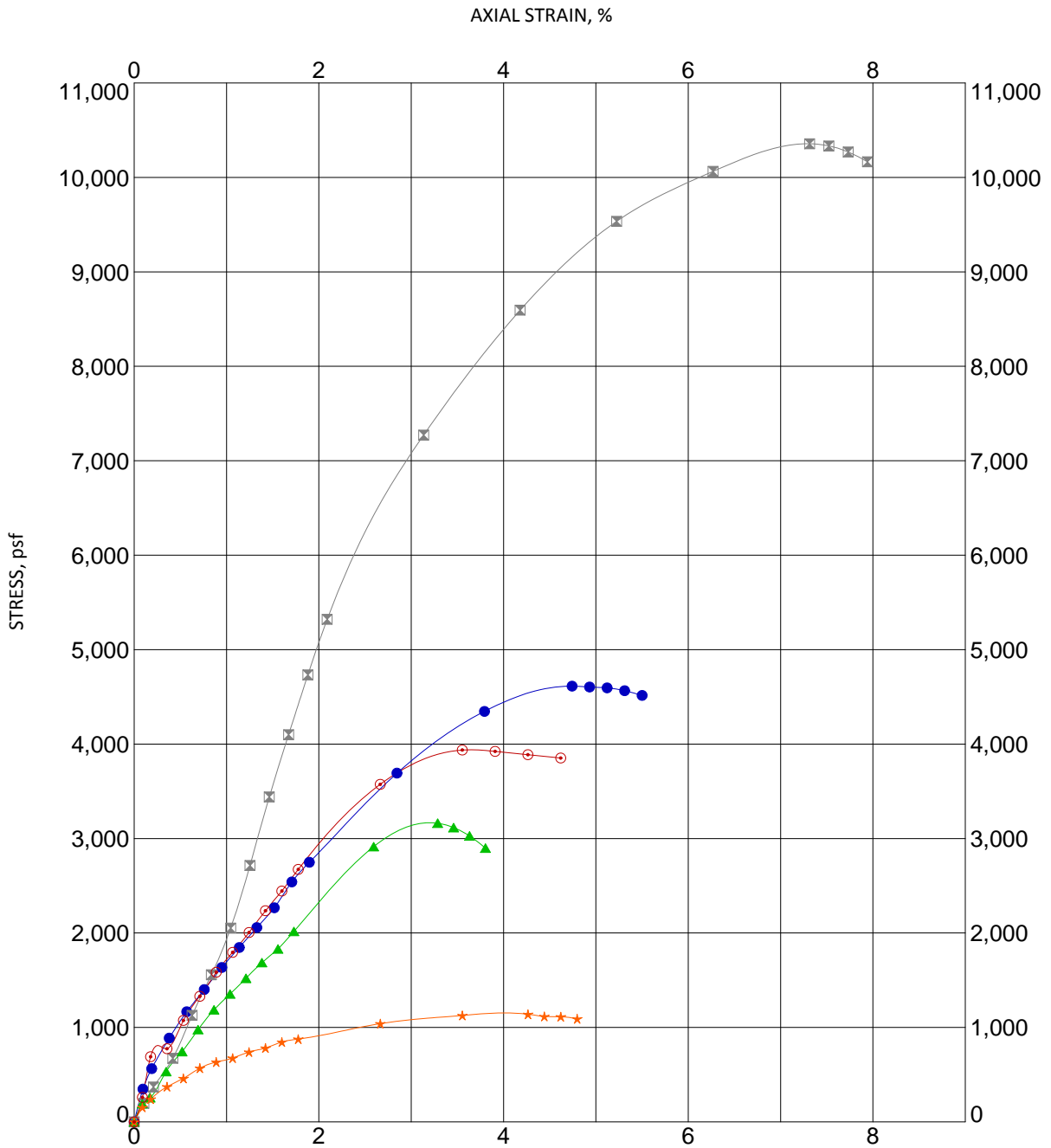

FIGURE B-3

Specimen Identification	Classification	Shear Str. (tsf)	Failure Strain (%)	PI	Dry Unit Weight (pcf)	w (%)
● B-14 8 ft		1.2	4.7		116.9	14.7
⊠ B-2 2 ft		2.6	7.3		119.3	10.9
▲ B-2 4 ft		0.8	3.3	15	104.0	16.6
★ B-2 6 ft		0.3	4.3		102.1	19.0
⊙ B-2 8 ft		1.0	3.6		110.3	16.9

R-K UNCONFINED COMPRESSION ASA12-098-00.GPJ RKCI.GDT 11/20/12



12821 W. Golden Lane
 San Antonio, Texas 78249
 (210) 699-9090
 (210) 699-6426 fax
 www.rkci.com

UNCONFINED COMPRESSION

Ash Pond Berms - Spruce/Deely Generation Units
 San Antonio, Texas

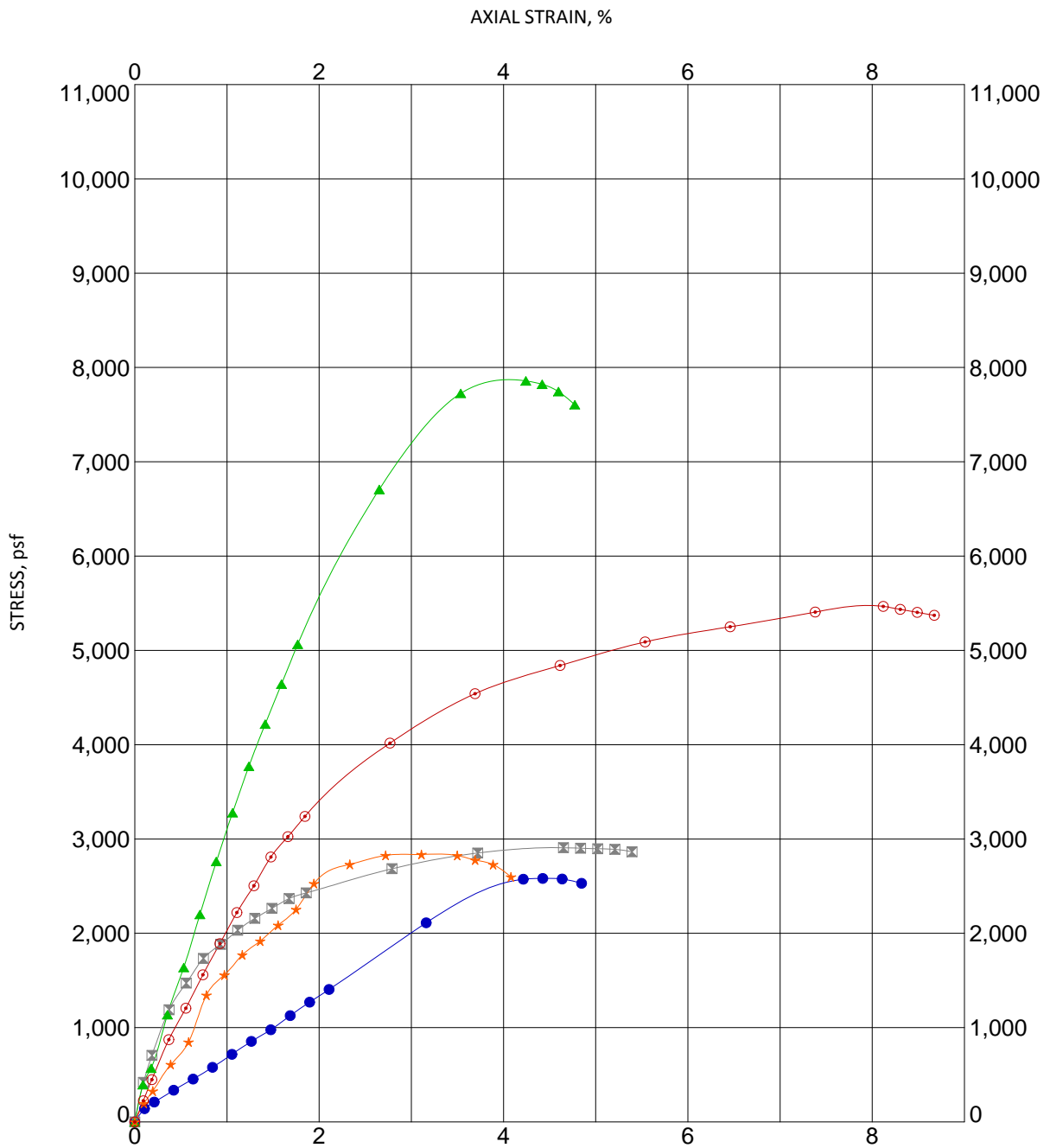

FIGURE B-4

Specimen Identification	Classification	Shear Str. (tsf)	Failure Strain (%)	PI	Dry Unit Weight (pcf)	w (%)
● B-2 18 ft		0.6	4.4		100.8	13.0
◻ B-3 13 ft		0.7	4.7	30	112.2	17.6
▲ B-4 6 ft		2.0	4.2		113.1	14.3
★ B-4 8 ft		0.7	3.1		109.8	10.6
○ B-7 6 ft		1.4	8.1		115.1	15.7

R-K UNCONFINED COMPRESSION ASA12-098-00.GPJ RKCI.GDT 11/20/12



12821 W. Golden Lane
 San Antonio, Texas 78249
 (210) 699-9090
 (210) 699-6426 fax
 www.rkci.com

UNCONFINED COMPRESSION

Ash Pond Berms - Spruce/Deely Generation Units
 San Antonio, Texas

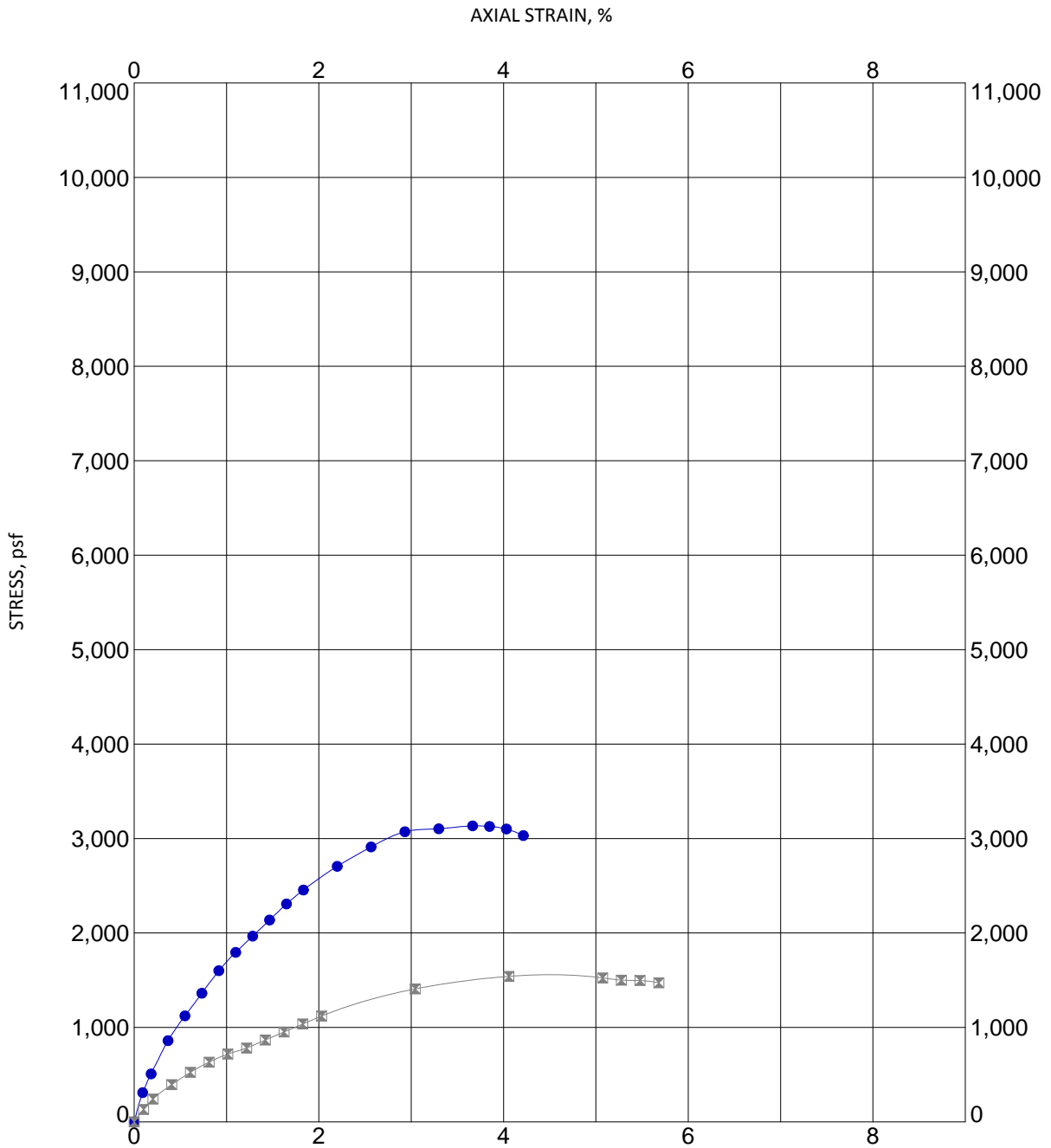

FIGURE B-5

Specimen Identification	Classification	Shear Str. (tsf)	Failure Strain (%)	PI	Dry Unit Weight (pcf)	w (%)
● B-8 6 ft		0.8	3.7		112.6	15.1
⊠ B-8 13 ft		0.4	4.1		110.8	18.1

R-K UNCONFINED COMPRESSION ASA12-098-00.GPJ RKCI.GDT 11/20/12



12821 W. Golden Lane
 San Antonio, Texas 78249
 (210) 699-9090
 (210) 699-6426 fax
 www.rkci.com

UNCONFINED COMPRESSION

Ash Pond Berms - Spruce/Deely Generation Units
 San Antonio, Texas

APPENDIX C

SLOPE STABILITY ANALYSES

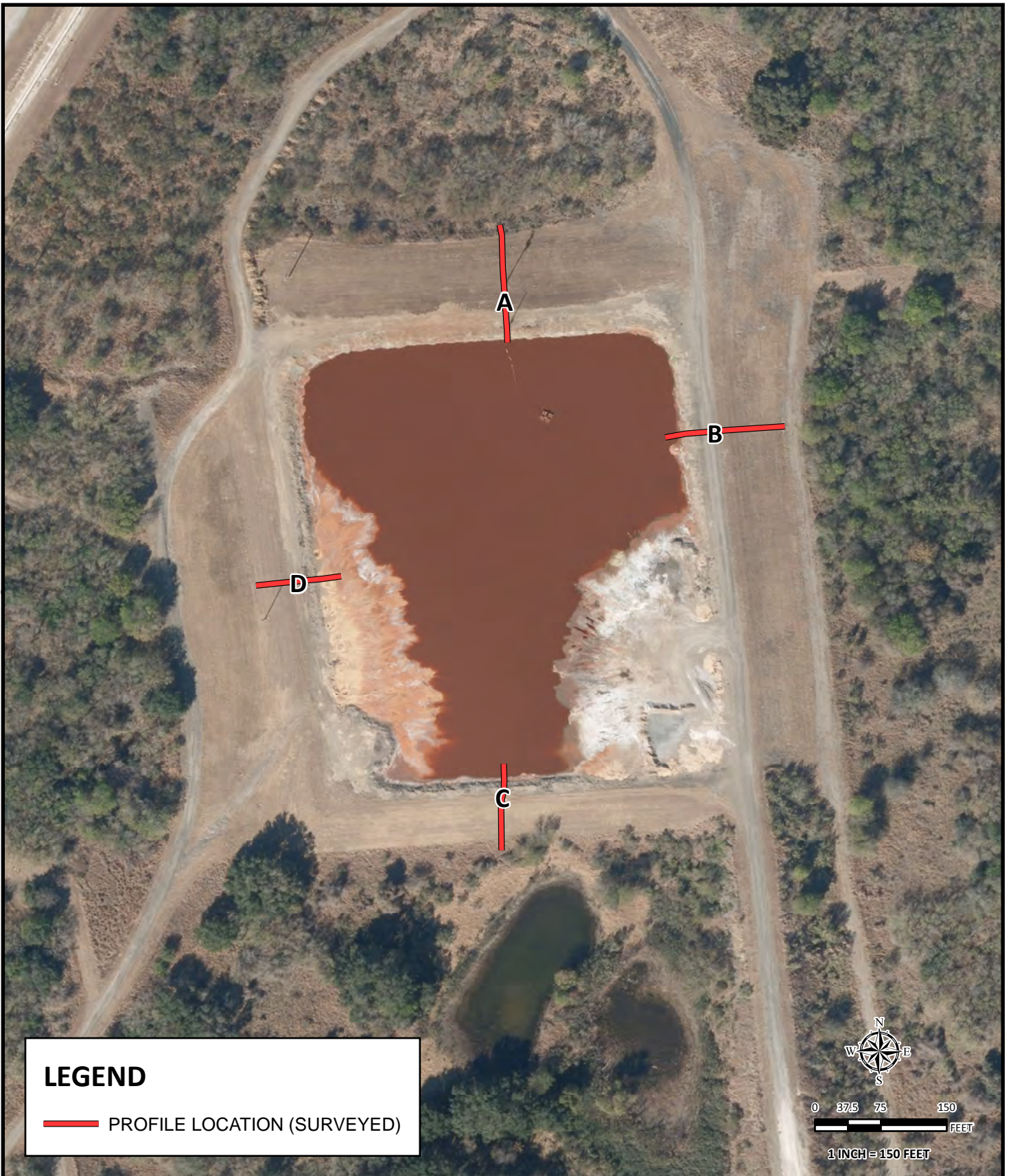

LEGEND

— PROFILE LOCATION (SURVEYED)

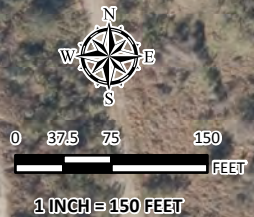

RABA KISTNER CONSULTANTS

Raba Kistner Consultants, Inc.
 12821 West Golden Lane
 San Antonio, Texas 78249
 P 210 :: 699 :: 9090
 F 210 :: 699 :: 6426
 www.rkci.com
 TBPE Firm Number 3257

SOURCE: 2011 Aerial Photograph Provided by the City of San Antonio (COSA)

SLOPE PROFILE LOCATION MAP

ASH POND BERMS - SPRUCE/DEELY GENERATION UNITS
 SAN ANTONIO, TEXAS

REVISIONS:		
No.	DATE	DESCRIPTION

PROJECT No.:
 ASA12-098-00

ISSUE DATE: 11/08/2012
 DRAWN BY: CCL
 CHECKED BY: RBW
 REVIEWED BY: GLB

FIGURE

C-1a

NOTE: This Drawing is Provided for Illustration Only, May Not be to Scale and is Not Suitable for Design or Construction Purposes



RABA KISTNER CONSULTANTS
 Raba Kistner Consultants, Inc.
 12821 West Golden Lane
 San Antonio, Texas 78249
 P 210 :: 699 :: 9090
 F 210 :: 699 :: 6426
 www.rkci.com
 TBPE Firm Number 3257

SOURCE: 2011 Aerial Photograph Provided by the City of San Antonio (COSA)

SLOPE PROFILE LOCATION MAP

ASH POND BERMS - SPRUCE/DEELY GENERATION UNITS
 SAN ANTONIO, TEXAS

REVISIONS:		
No.	DATE	DESCRIPTION

PROJECT No.: ASA12-098-00

ISSUE DATE: 11/20/2012

DRAWN BY: CCL



CHECKED BY: RBW

REVIEWED BY: GLB

FIGURE

C-1b

Global Stability Analysis

Material Name	Color	Unit Weight (lbs/ft ³)	Strength Type	Shear Normal Function
Embankment Fill		120	Shear Normal function	Pond 3 Embankment Soil
Clayey Sand		120	Shear Normal function	Pond 3 Clayey Sand

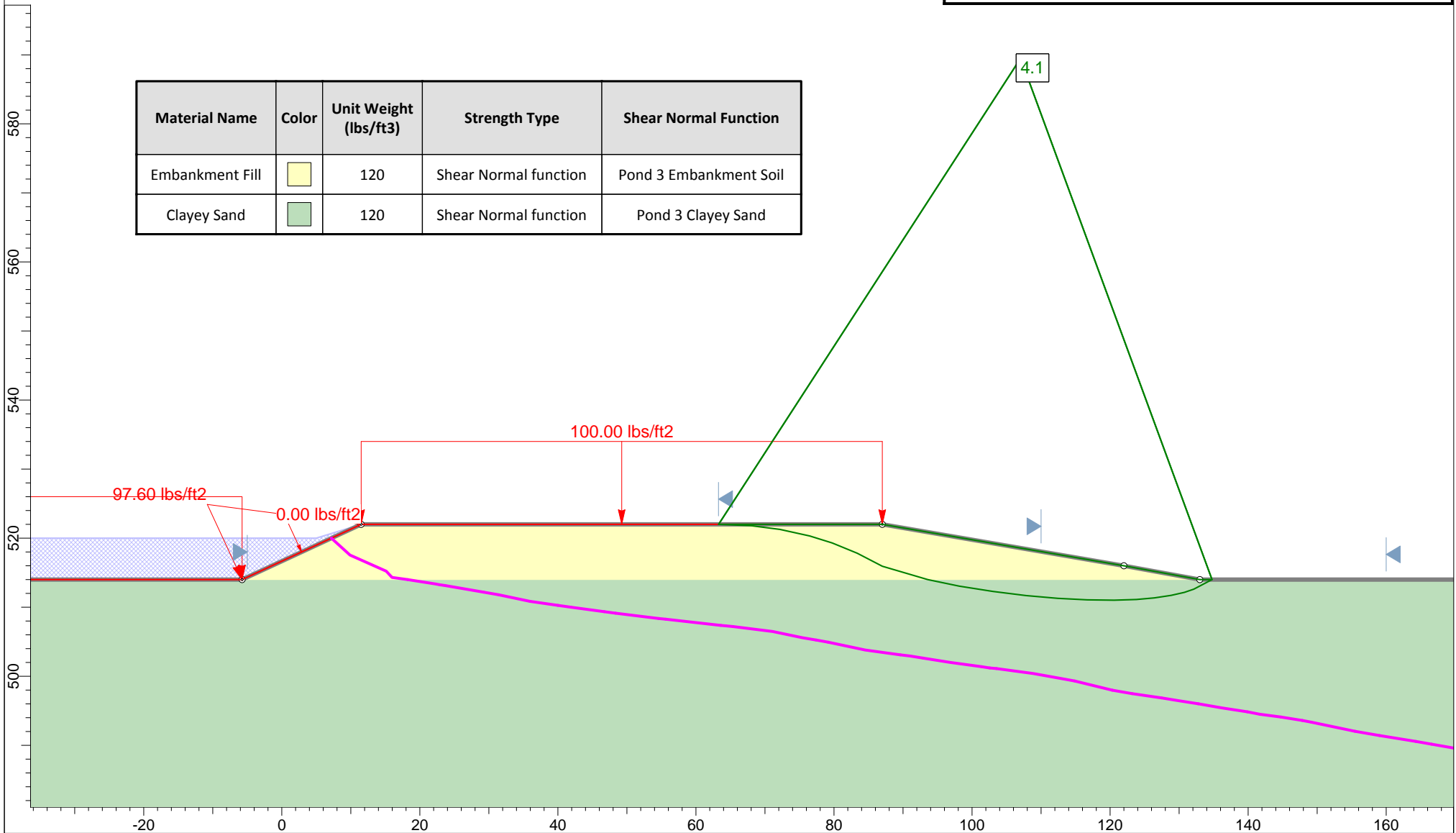



Profile "A" - Steady State
Ash Pond Berms - Spruce/Deely Generation Units

Raba Kistner Consultants, Inc.
ASA12-098-00

Figure C-2a



Global Stability Analysis

Material Name	Color	Unit Weight (lbs/ft3)	Strength Type	Shear Normal Function
Embankment Fill		120	Shear Normal function	Pond 3 Embankment Soil
Clayey Sand		120	Shear Normal function	Pond 3 Clayey Sand

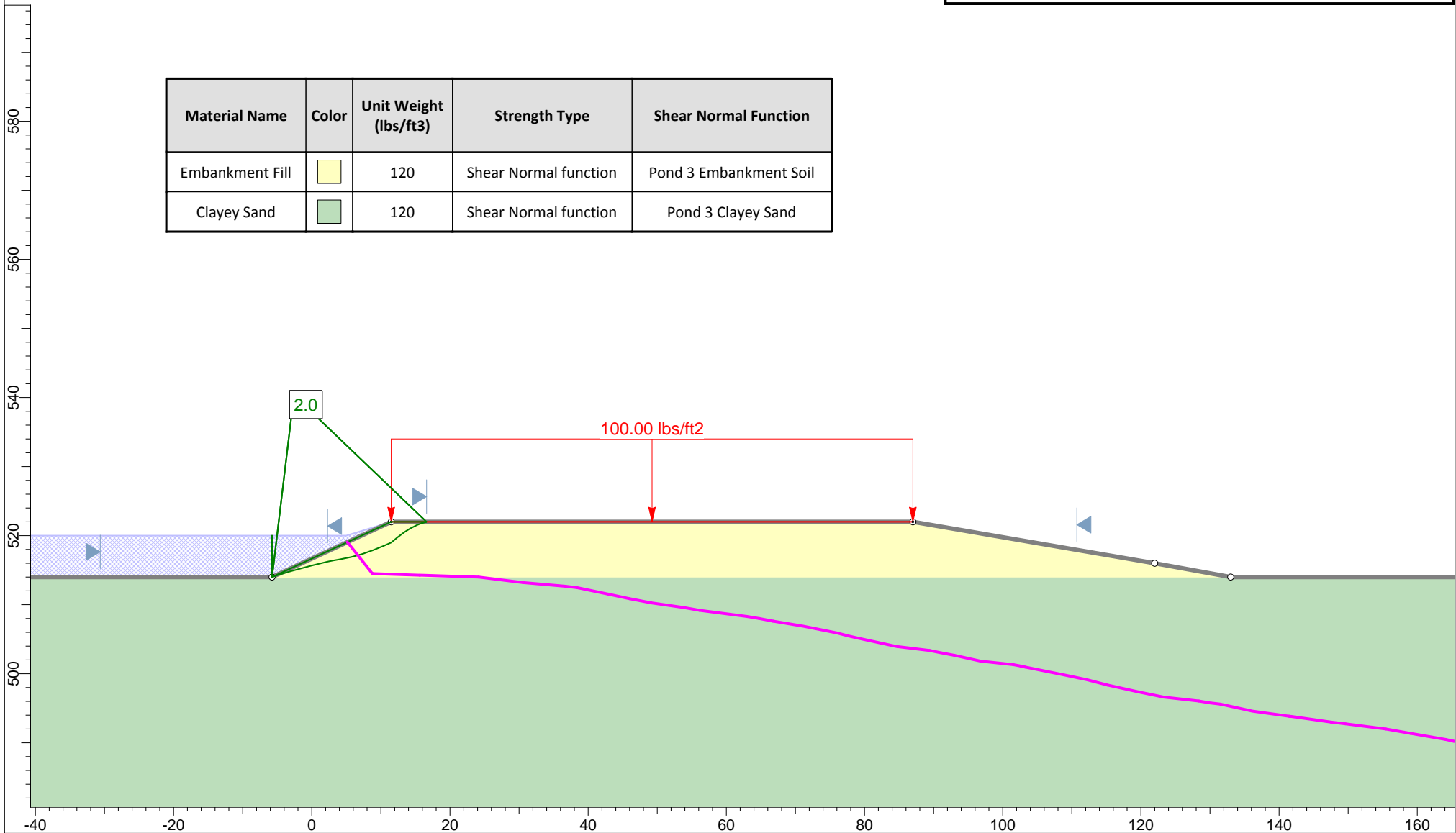



Profile "A" - Steady State
Ash Pond Berms - Spruce/Deely Generation Units

Raba Kistner Consultants, Inc.
ASA12-098-00

Figure C-2b



Global Stability Analysis

Material Name	Color	Unit Weight (lbs/ft ³)	Strength Type	Shear Normal Function
Embankment Fill		120	Shear Normal function	Pond 3 Embankment Soil
Clayey Sand		120	Shear Normal function	Pond 3 Clayey Sand
Sandy Clay		120	Shear Normal function	Pond 3 Sandy Clay

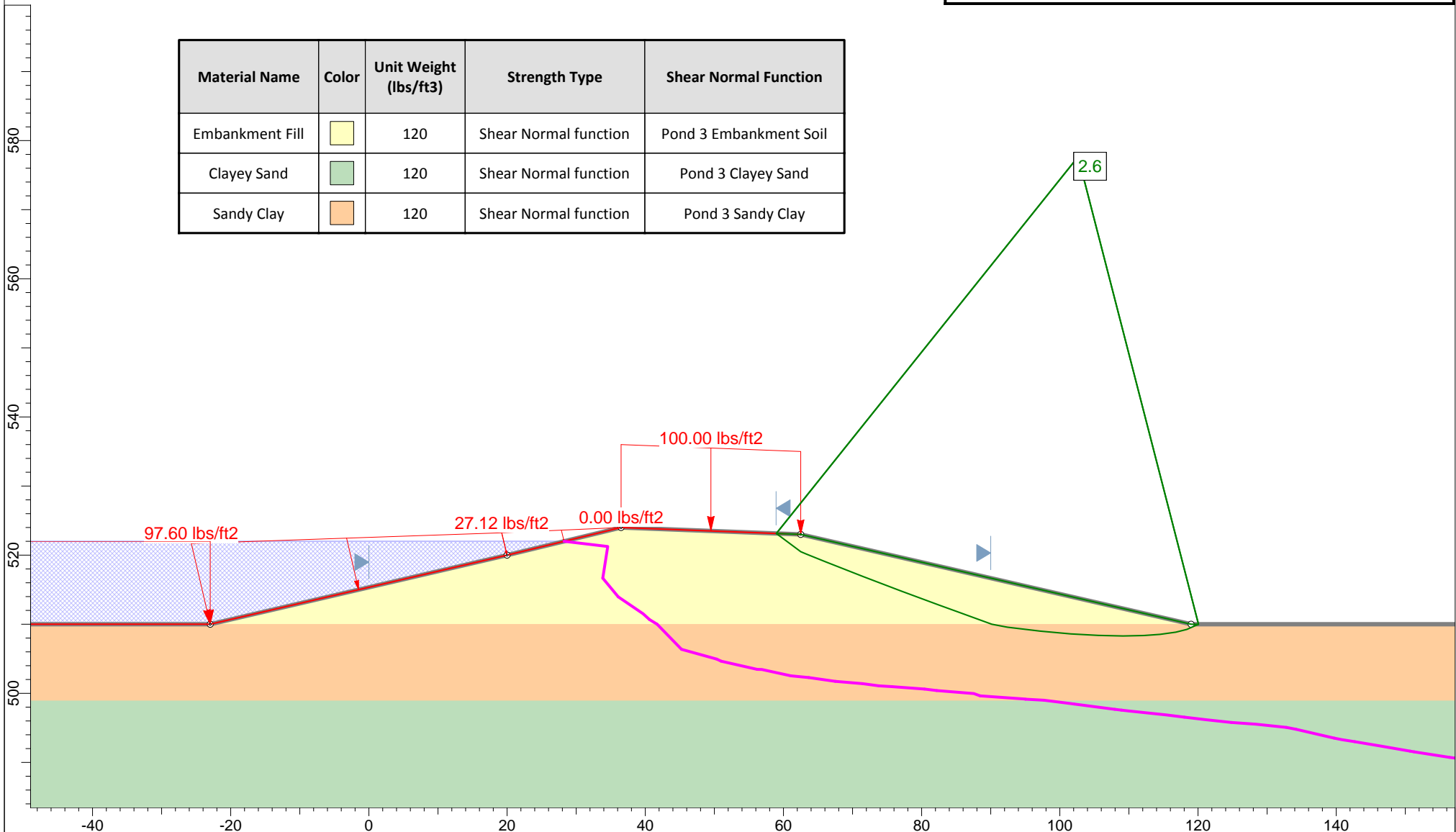



Profile "B" - Steady State
Ash Pond Berms - Spruce/Deely Generation Units

Raba Kistner Consultants, Inc.
ASA12-098-00

Figure C-3a



Global Stability Analysis

Material Name	Color	Unit Weight (lbs/ft ³)	Strength Type	Shear Normal Function
Embankment Fill		120	Shear Normal function	Pond 3 Embankment Soil
Clayey Sand		120	Shear Normal function	Pond 3 Clayey Sand
Sandy Clay		120	Shear Normal function	Pond 3 Sandy Clay

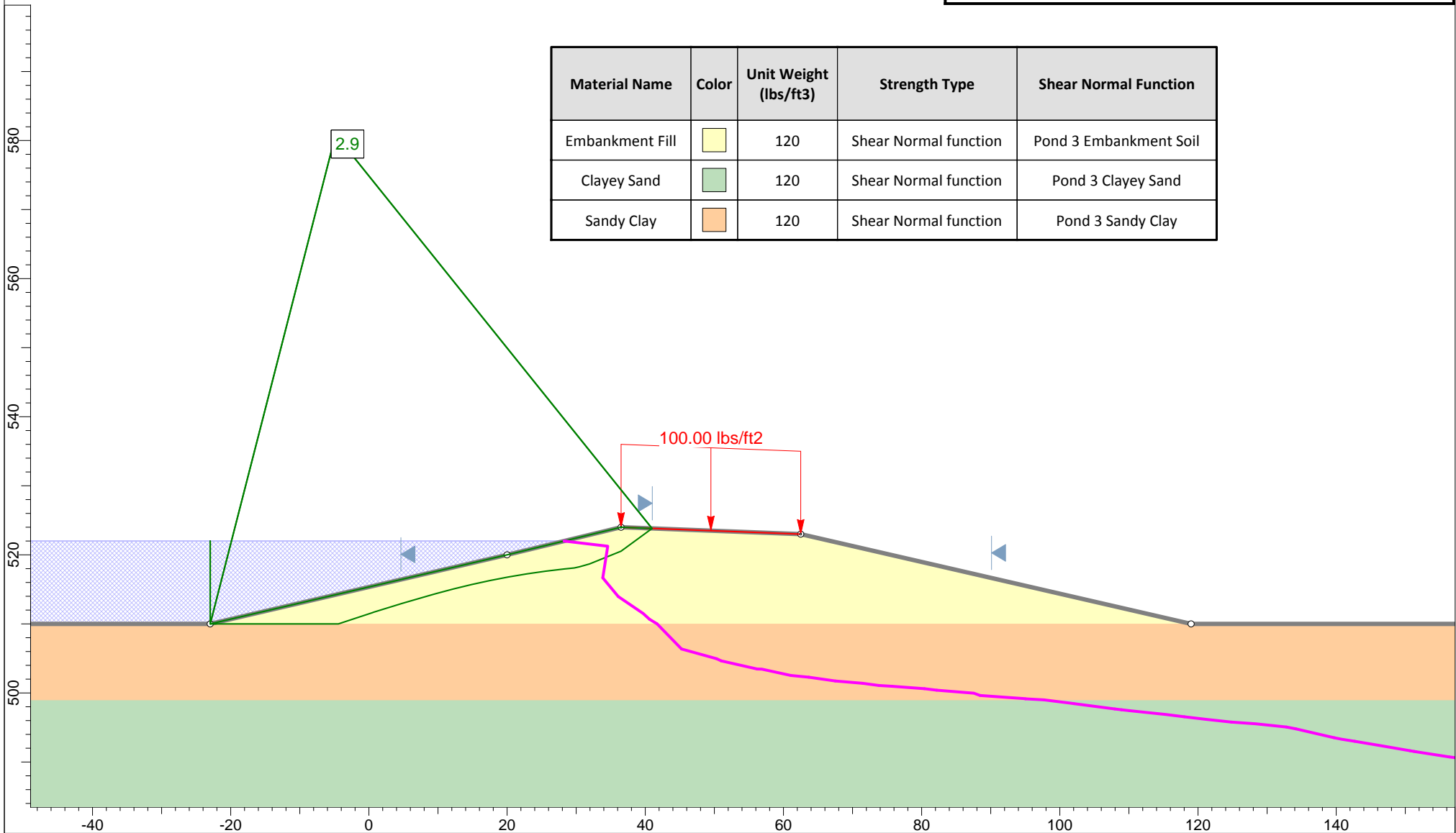

Profile "B" - Steady State
Ash Pond Berms - Spruce/Deely Generation Units

Raba Kistner Consultants, Inc.
ASA12-098-00

Figure C-3b



Global Stability Analysis

Material Name	Color	Unit Weight (lbs/ft ³)	Strength Type	Shear Normal Function
Embankment Fill	Yellow	120	Shear Normal function	Pond 3 Embankment Soil
Clayey Sand	Green	120	Shear Normal function	Pond 3 Clayey Sand

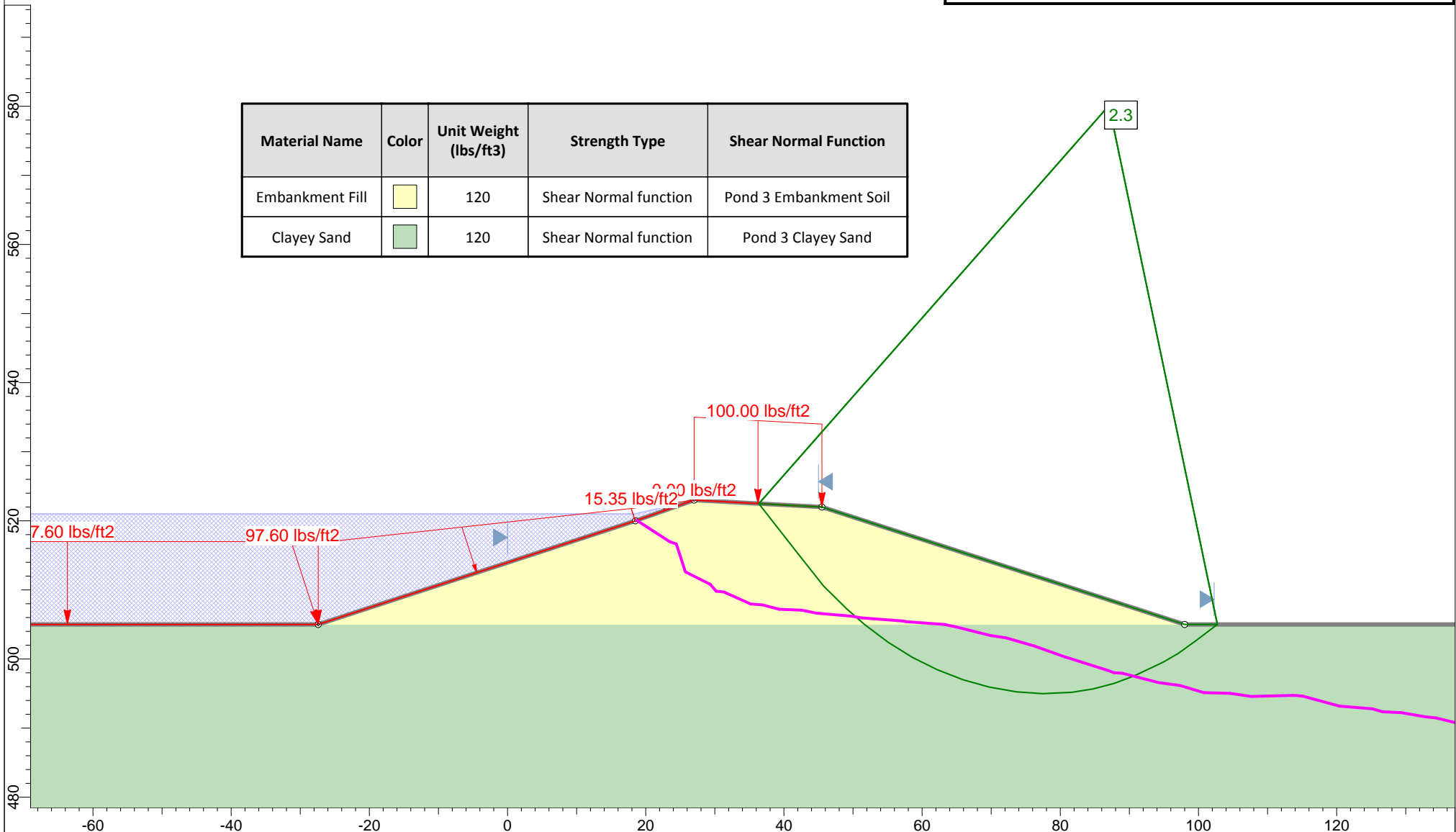



Profile "C" - Steady State
Ash Pond Berms - Spruce/Deely Generation Units

Raba Kistner Consultants, Inc.
ASA12-098-00

Figure C-4a



Global Stability Analysis

Material Name	Color	Unit Weight (lbs/ft ³)	Strength Type	Shear Normal Function
Embankment Fill		120	Shear Normal function	Pond 3 Embankment Soil
Clayey Sand		120	Shear Normal function	Pond 3 Clayey Sand

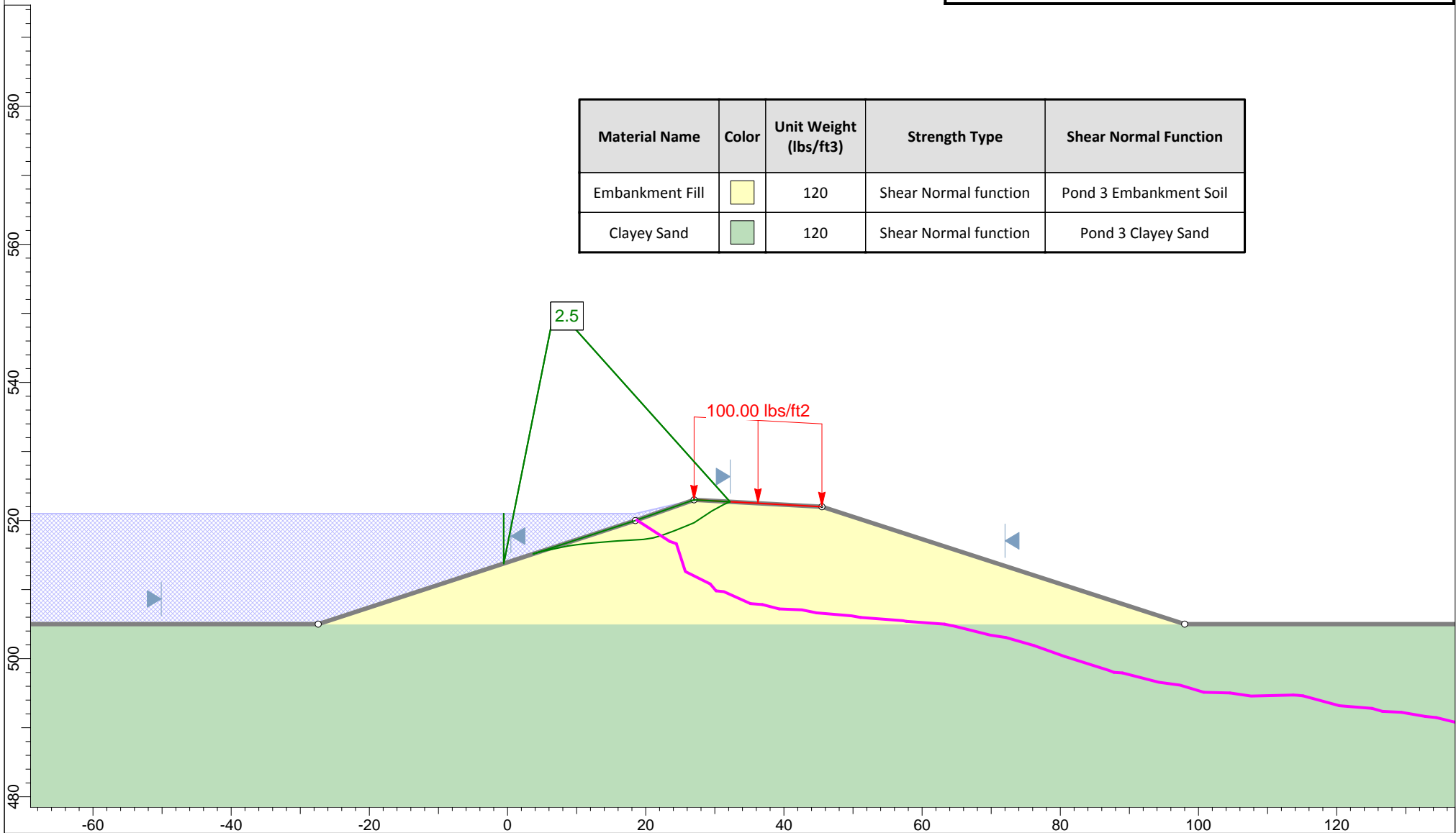



Profile "C" - Steady State
Ash Pond Berms - Spruce/Deely Generation Units

Raba Kistner Consultants, Inc.
ASA12-098-00

Figure C-4b



Global Stability Analysis

Material Name	Color	Unit Weight (lbs/ft ³)	Strength Type	Shear Normal Function
Embankment Fill		120	Shear Normal function	Pond 3 Embankment Soil
Clayey Sand		120	Shear Normal function	Pond 3 Clayey Sand
Sandy Clay		120	Shear Normal function	Pond 3 Sandy Clay

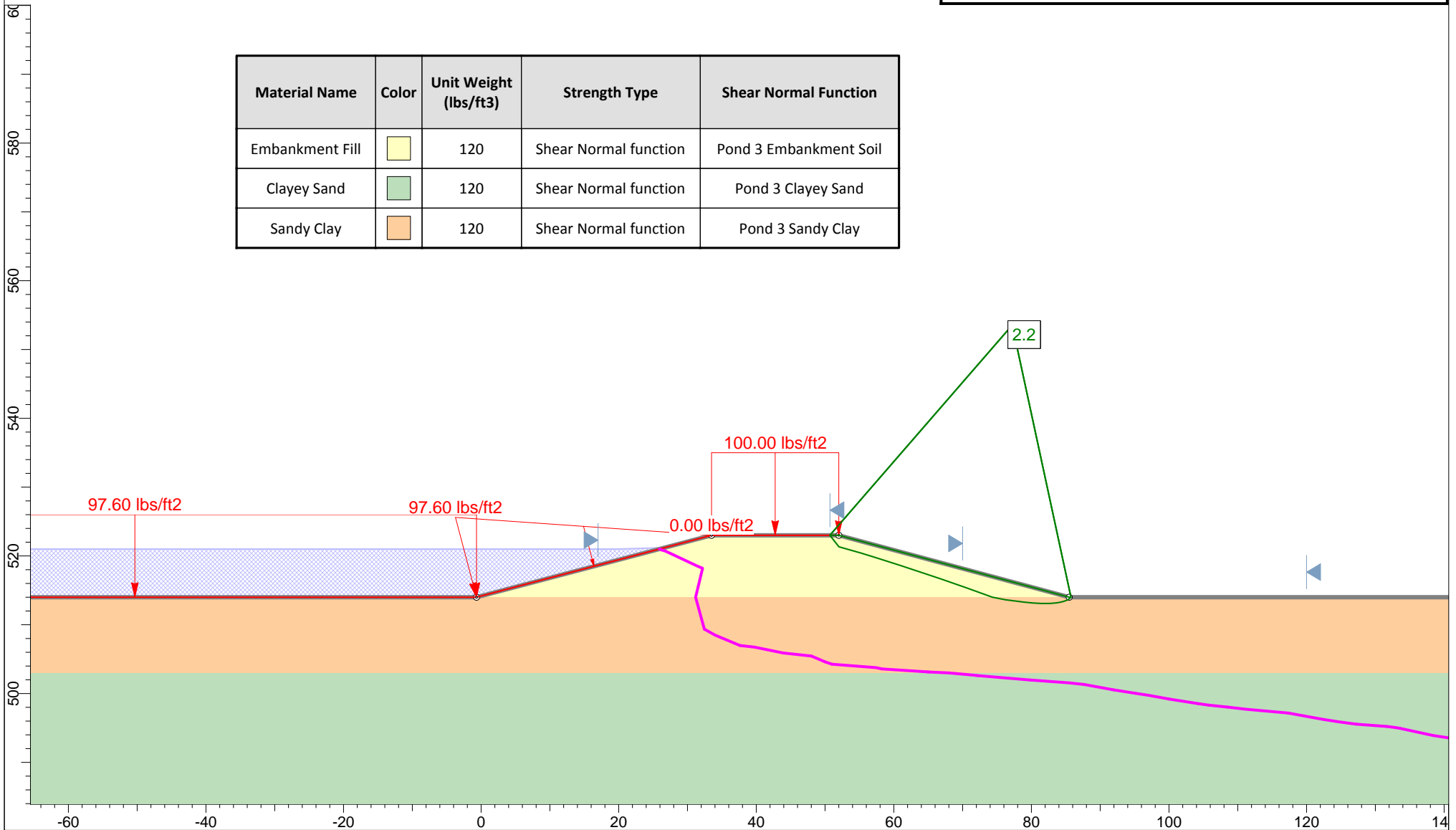



Profile "D" - Steady State
Ash Pond Berms - Spruce/Deely Generation Units

Raba Kistner Consultants, Inc.
ASA12-098-00

Figure C-5a



Global Stability Analysis

Material Name	Color	Unit Weight (lbs/ft ³)	Strength Type	Shear Normal Function
Embankment Fill		120	Shear Normal function	Pond 3 Embankment Soil
Clayey Sand		120	Shear Normal function	Pond 3 Clayey Sand
Sandy Clay		120	Shear Normal function	Pond 3 Sandy Clay

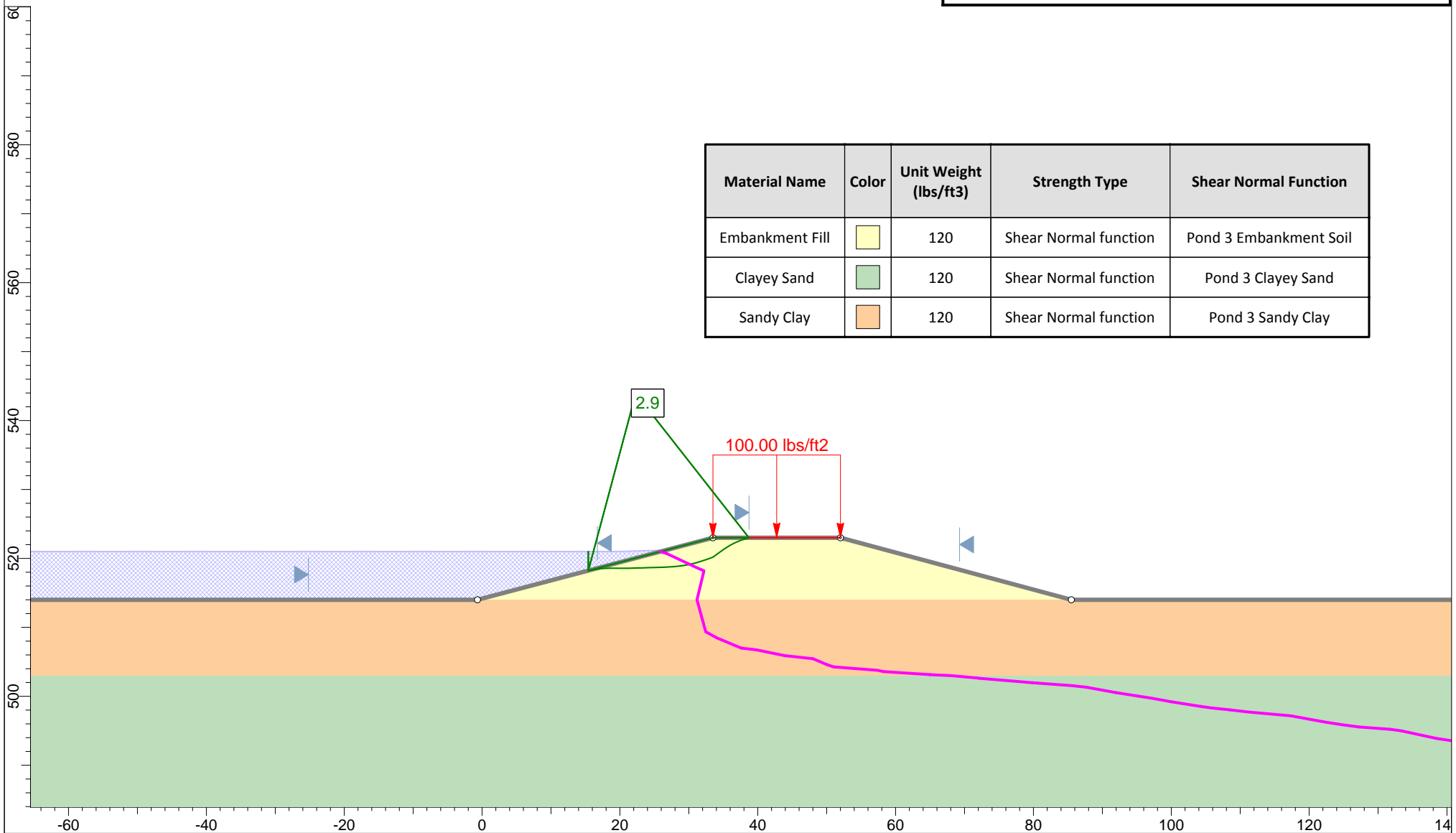



Profile "D" - Steady State
Ash Pond Berms - Spruce/Deely Generation Units

Raba Kistner Consultants, Inc.
ASA12-098-00

Figure C-5b



Global Stability Analysis

Material Name	Color	Unit Weight (lbs/ft ³)	Strength Type	Shear Normal Function
Embankment Soil		120	Shear Normal function	Pond 2 Embankment Soil
Clayey Sand		120	Shear Normal function	Pond 2 Clayey Sand
Sandy Clay		120	Shear Normal function	Pond 2 Sandy Clay

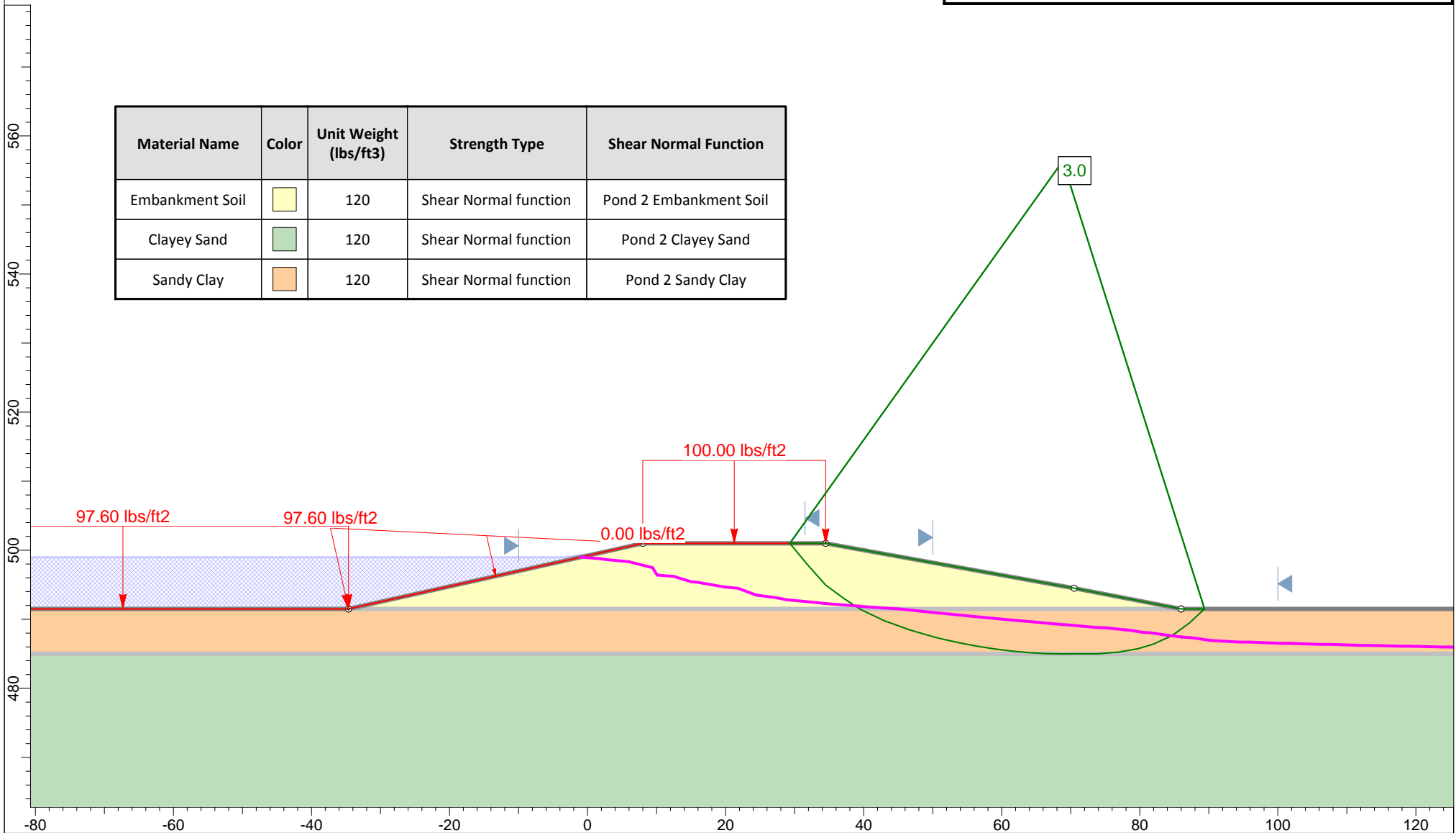

Profile "E" - Steady State
Ash Pond Berms - Spruce/Deely Generation Units

Raba Kistner Consultants, Inc.
ASA12-098-00

Figure C-6a



Global Stability Analysis

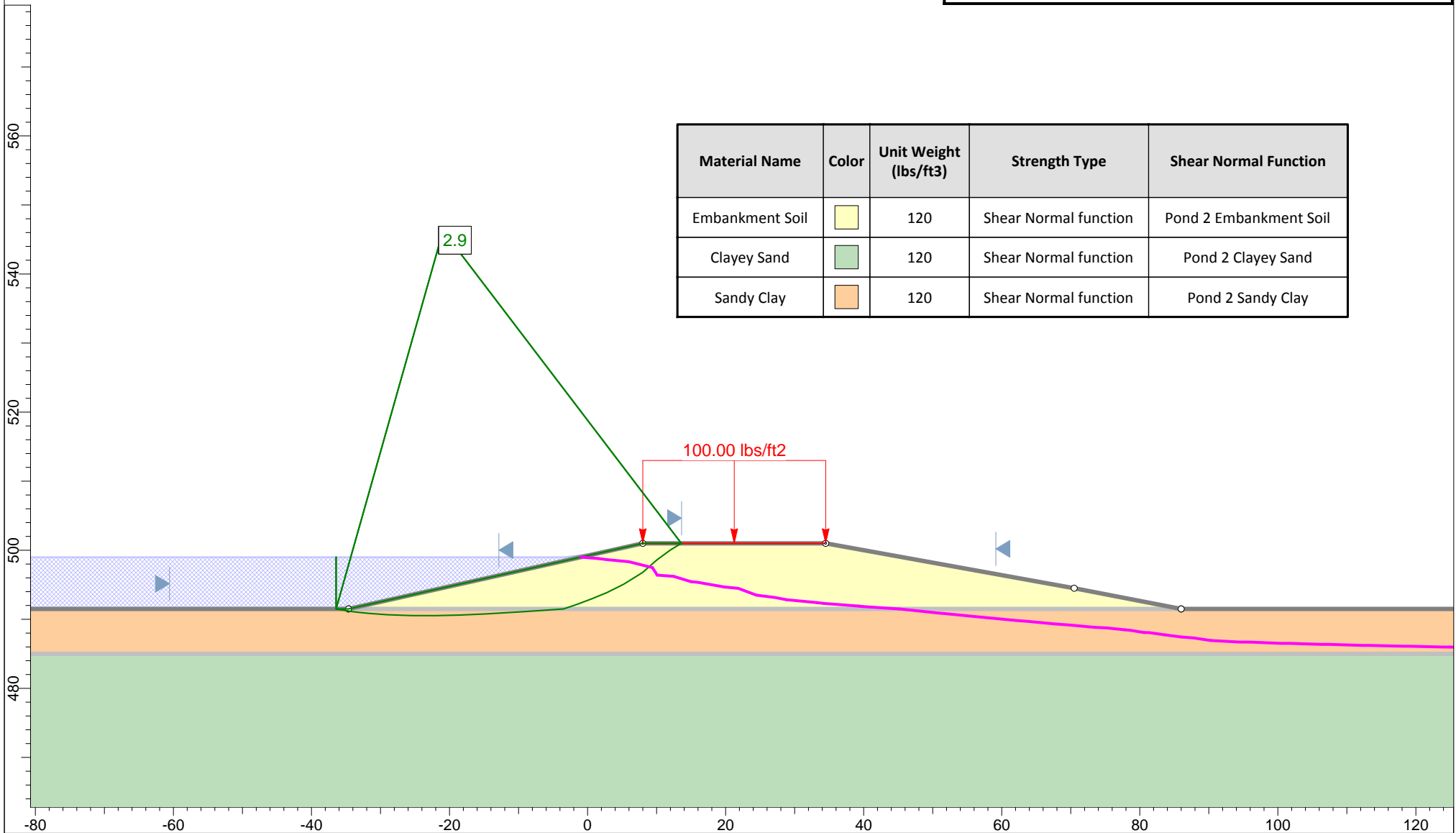

Material Name	Color	Unit Weight (lbs/ft ³)	Strength Type	Shear Normal Function
Embankment Soil		120	Shear Normal function	Pond 2 Embankment Soil
Clayey Sand		120	Shear Normal function	Pond 2 Clayey Sand
Sandy Clay		120	Shear Normal function	Pond 2 Sandy Clay

Profile "E" - Steady State
Ash Pond Berms - Spruce/Deely Generation Units

Raba Kistner Consultants, Inc.
ASA12-098-00

Figure C-6b



Global Stability Analysis

Material Name	Color	Unit Weight (lbs/ft ³)	Strength Type	Shear Normal Function
Embankment Fill	Yellow	120	Shear Normal function	Pond 2 Embankment Soil
Clayey Sand	Green	120	Shear Normal function	Pond 2 Clayey Sand
Sandy Clay	Orange	120	Shear Normal function	Pond 2 Sandy Clay

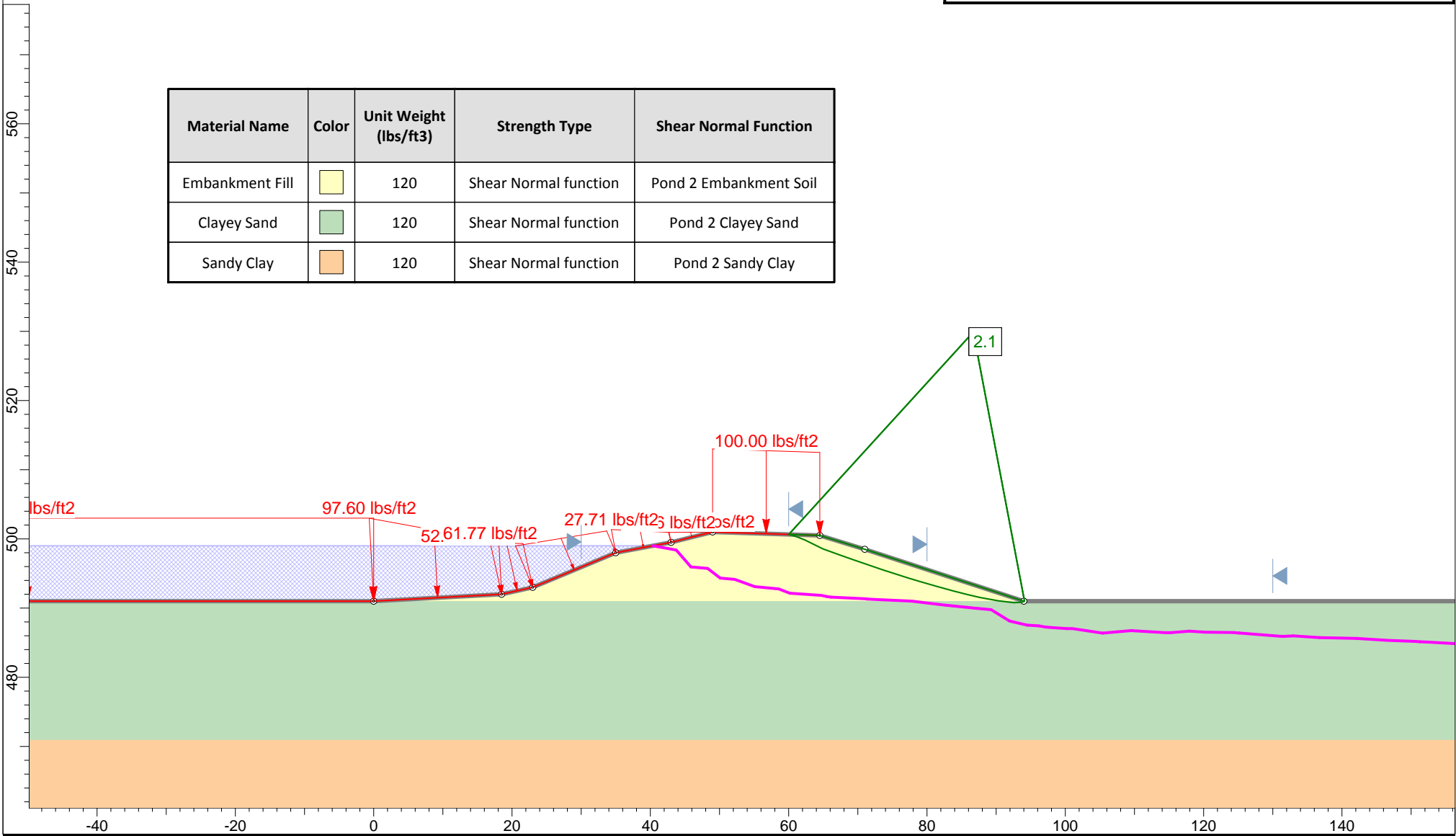



Profile "F" - Steady State
Ash Pond Berms - Spruce/Deely Generation Units

Raba Kistner Consultants, Inc.
ASA12-098-00

Figure C-7a



Global Stability Analysis

Material Name	Color	Unit Weight (lbs/ft ³)	Strength Type	Shear Normal Function
Embankment Fill		120	Shear Normal function	Pond 2 Embankment Soil
Clayey Sand		120	Shear Normal function	Pond 2 Clayey Sand
Sandy Clay		120	Shear Normal function	Pond 2 Sandy Clay

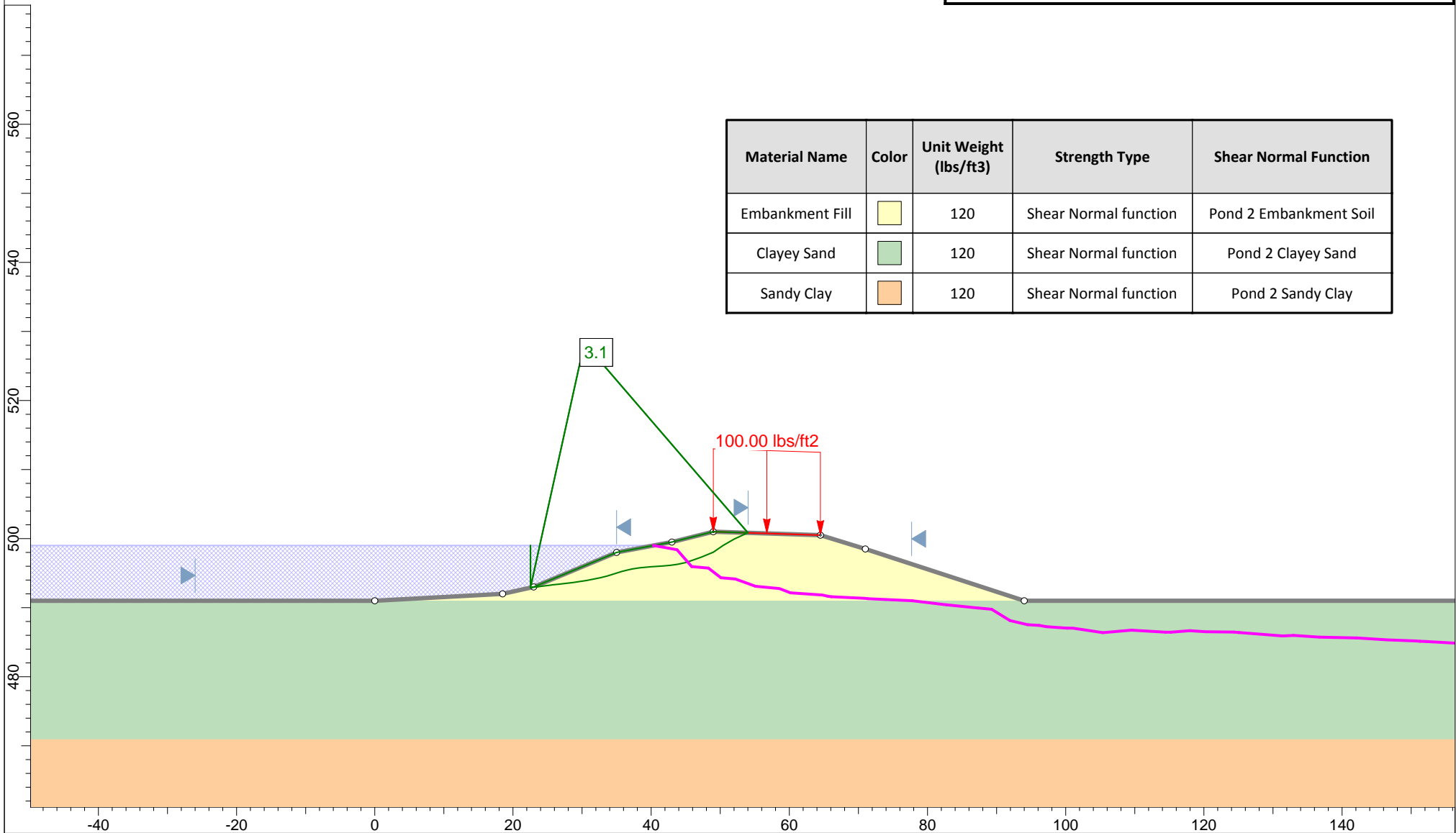



Profile "F" - Steady State
Ash Pond Berms - Spruce/Deely Generation Units

Raba Kistner Consultants, Inc.
ASA12-098-00

Figure C-7b



Global Stability Analysis

Material Name	Color	Unit Weight (lbs/ft ³)	Strength Type	Shear Normal Function
Embankment Fill		120	Shear Normal function	Pond 2 Embankment Soil
Clayey Sand		120	Shear Normal function	Pond 2 Clayey Sand
Sandy Clay		120	Shear Normal function	Pond 2 Sandy Clay

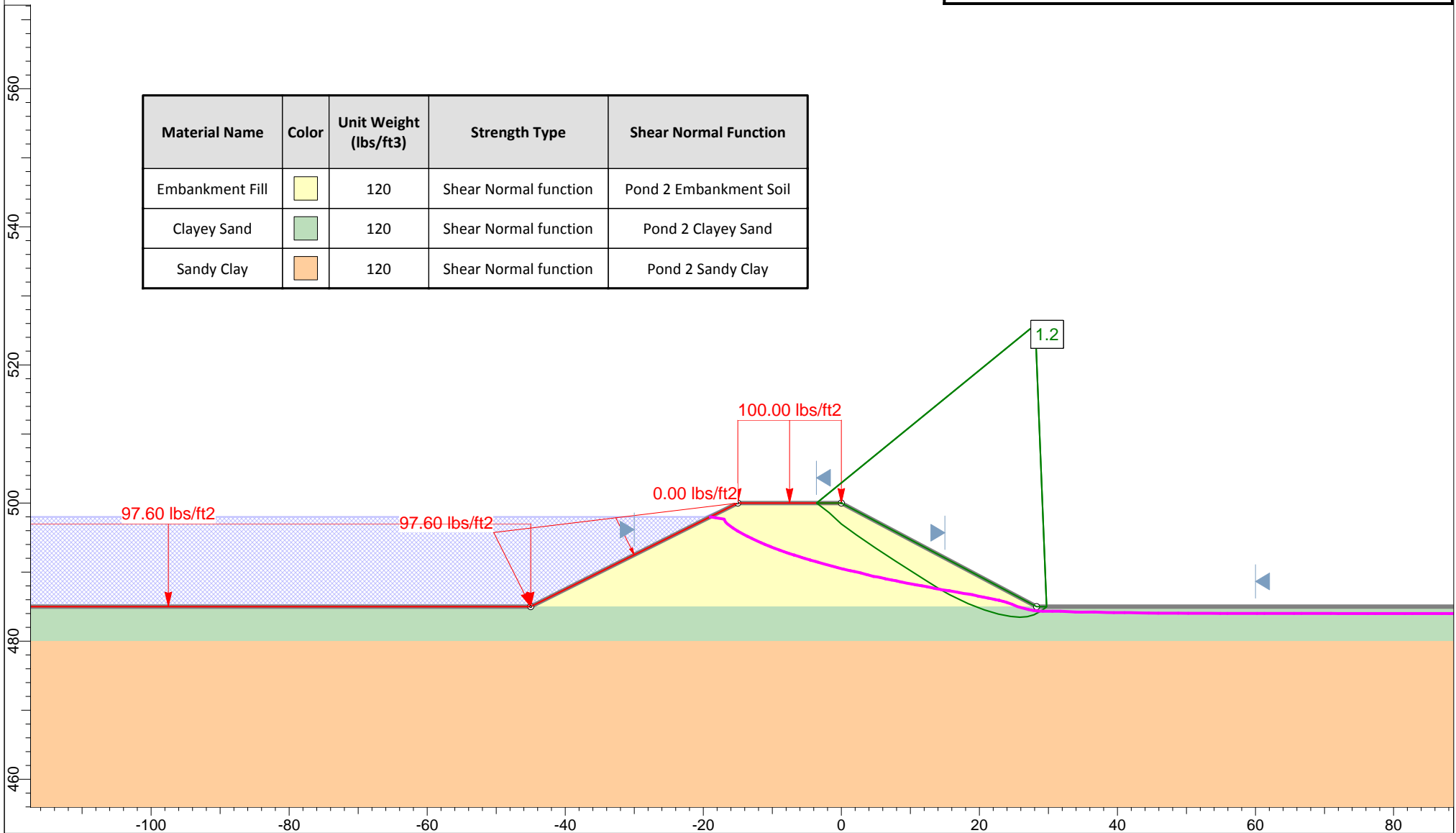



Profile "G" - Steady State
Ash Pond Berms - Spruce/Deely Generation Units

Raba Kistner Consultants, Inc.
ASA12-098-00

Figure C-8a



Global Stability Analysis

Material Name	Color	Unit Weight (lbs/ft3)	Strength Type	Shear Normal Function
Embankment Fill		120	Shear Normal function	Pond 2 Embankment Soil
Clayey Sand		120	Shear Normal function	Pond 2 Clayey Sand
Sandy Clay		120	Shear Normal function	Pond 2 Sandy Clay

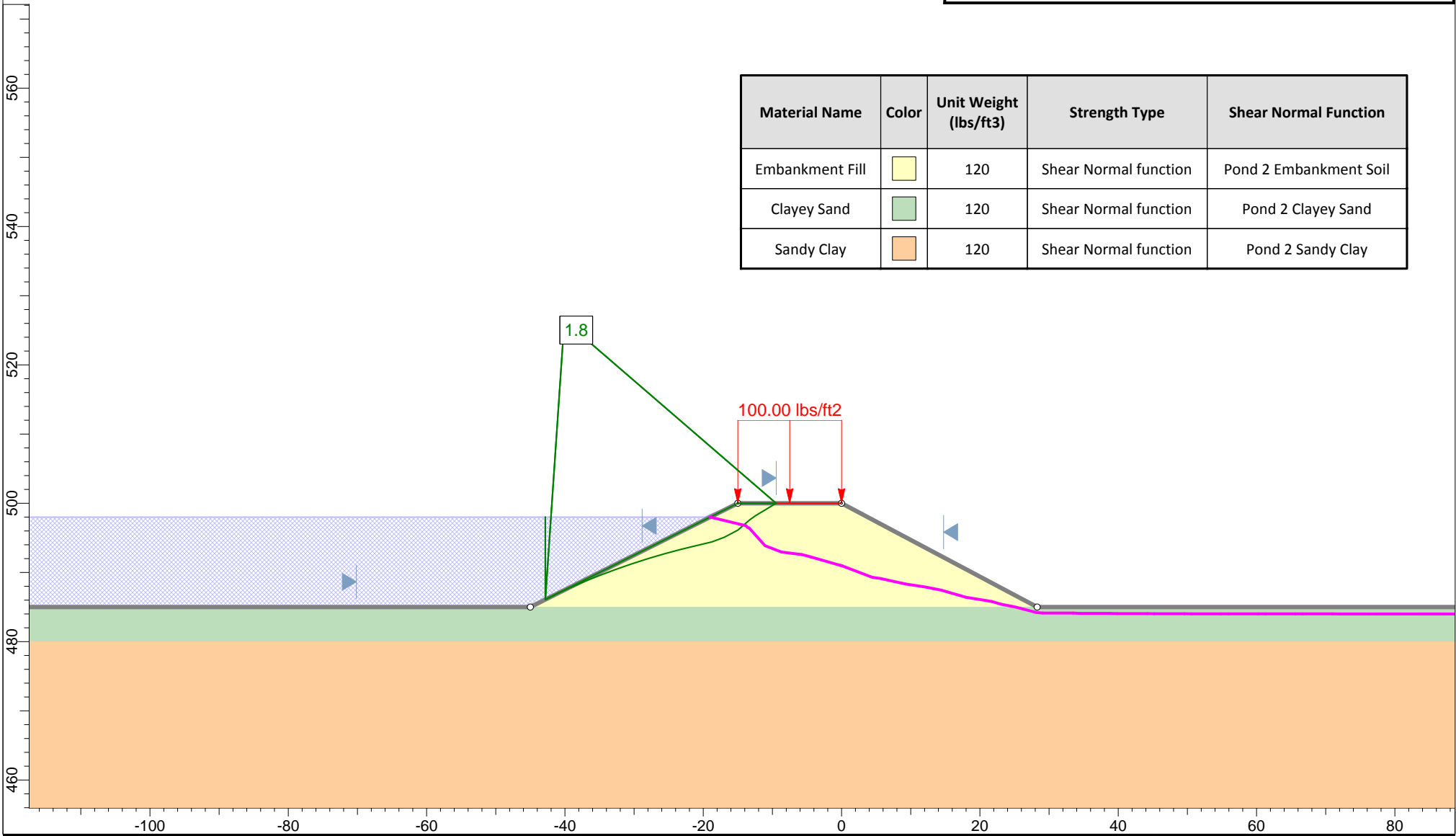



Profile "G" - Steady State
Ash Pond Berms - Spruce/Deely Generation Units

Raba Kistner Consultants, Inc.
ASA12-098-00

Figure C-8b



Global Stability Analysis

Material Name	Color	Unit Weight (lbs/ft ³)	Strength Type	Shear Normal Function
Embankment Fill		120	Shear Normal function	Pond 2 Embankment Soil
Clayey Sand		120	Shear Normal function	Pond 2 Clayey Sand
Sandy Clay		120	Shear Normal function	Pond 2 Sandy Clay

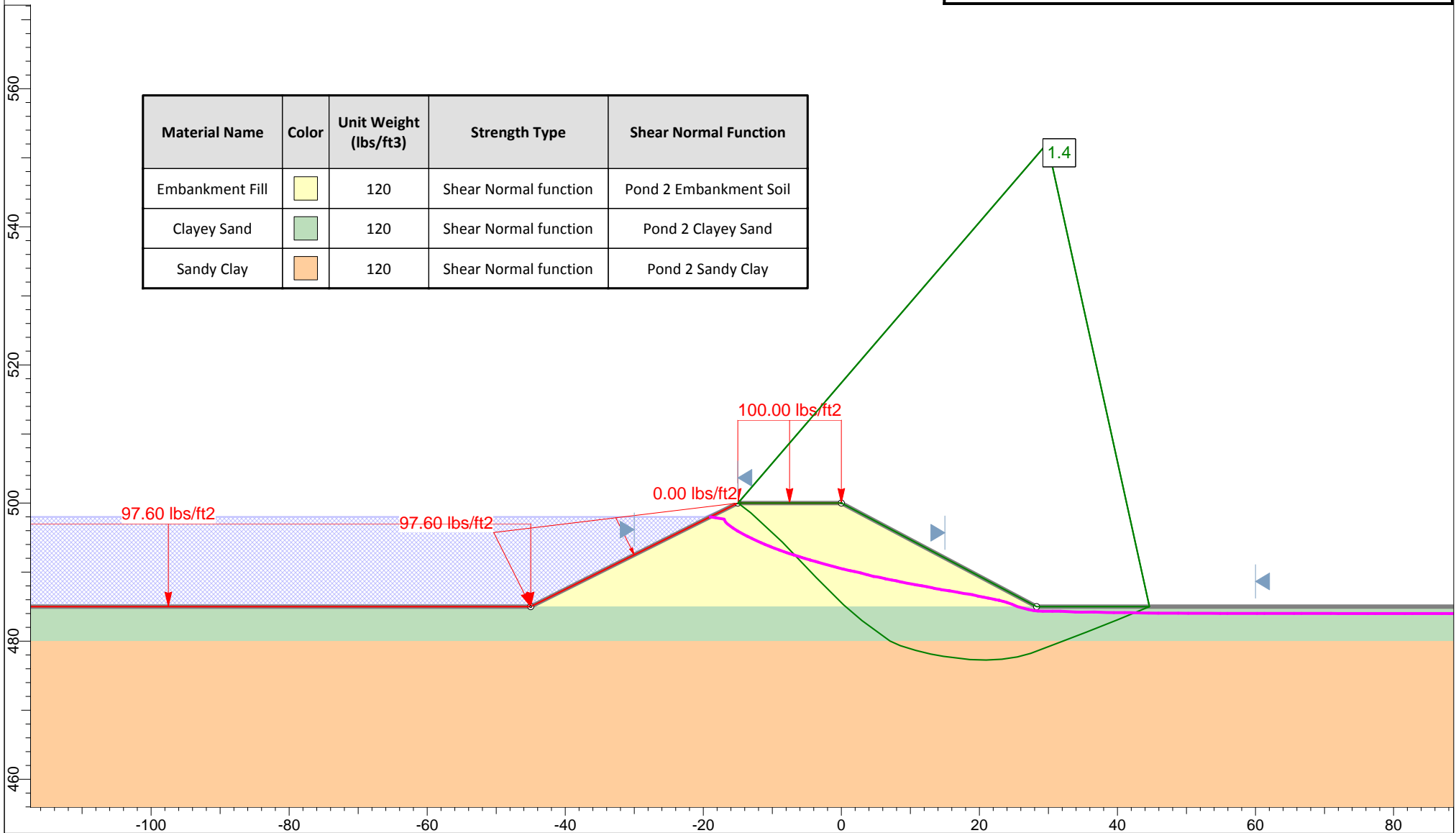



Profile "G" - Steady State
Ash Pond Berms - Spruce/Deely Generation Units

Raba Kistner Consultants, Inc.
ASA12-098-00

Figure C-8c



Global Stability Analysis

Material Name	Color	Unit Weight (lbs/ft ³)	Strength Type	Shear Normal Function
Embankment Fill		120	Shear Normal function	Pond 2 Embankment Soil
Clayey Sand		120	Shear Normal function	Pond 2 Clayey Sand
Sandy Clay		120	Shear Normal function	Pond 2 Sandy Clay

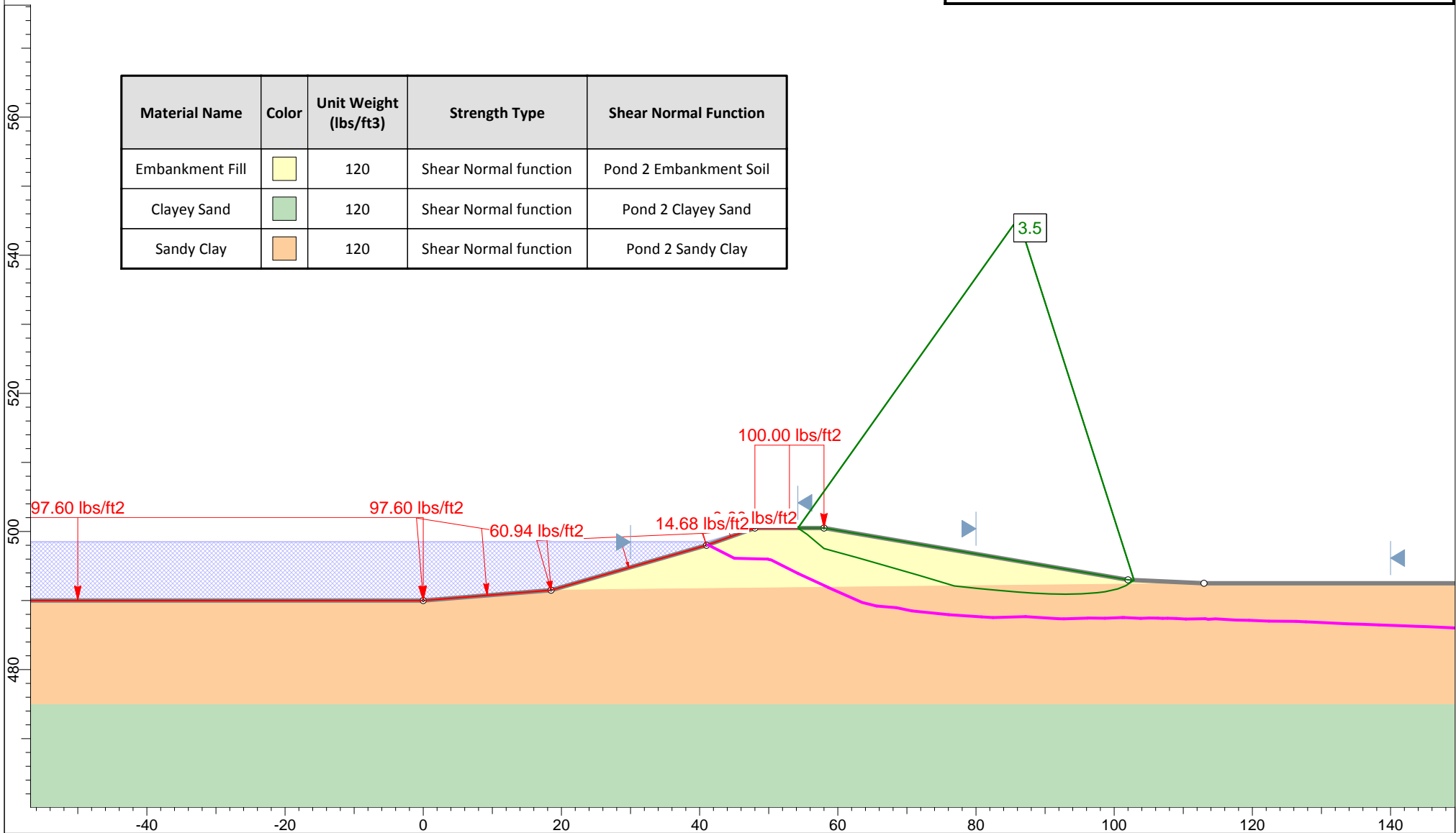



Profile "H" - Steady State
Ash Pond Berms - Spruce/Deely Generation Units

Raba Kistner Consultants, Inc.
ASA12-098-00

Figure C-9a



Global Stability Analysis

Material Name	Color	Unit Weight (lbs/ft ³)	Strength Type	Shear Normal Function
Embankment Fill		120	Shear Normal function	Pond 2 Embankment Soil
Clayey Sand		120	Shear Normal function	Pond 2 Clayey Sand
Sandy Clay		120	Shear Normal function	Pond 2 Sandy Clay

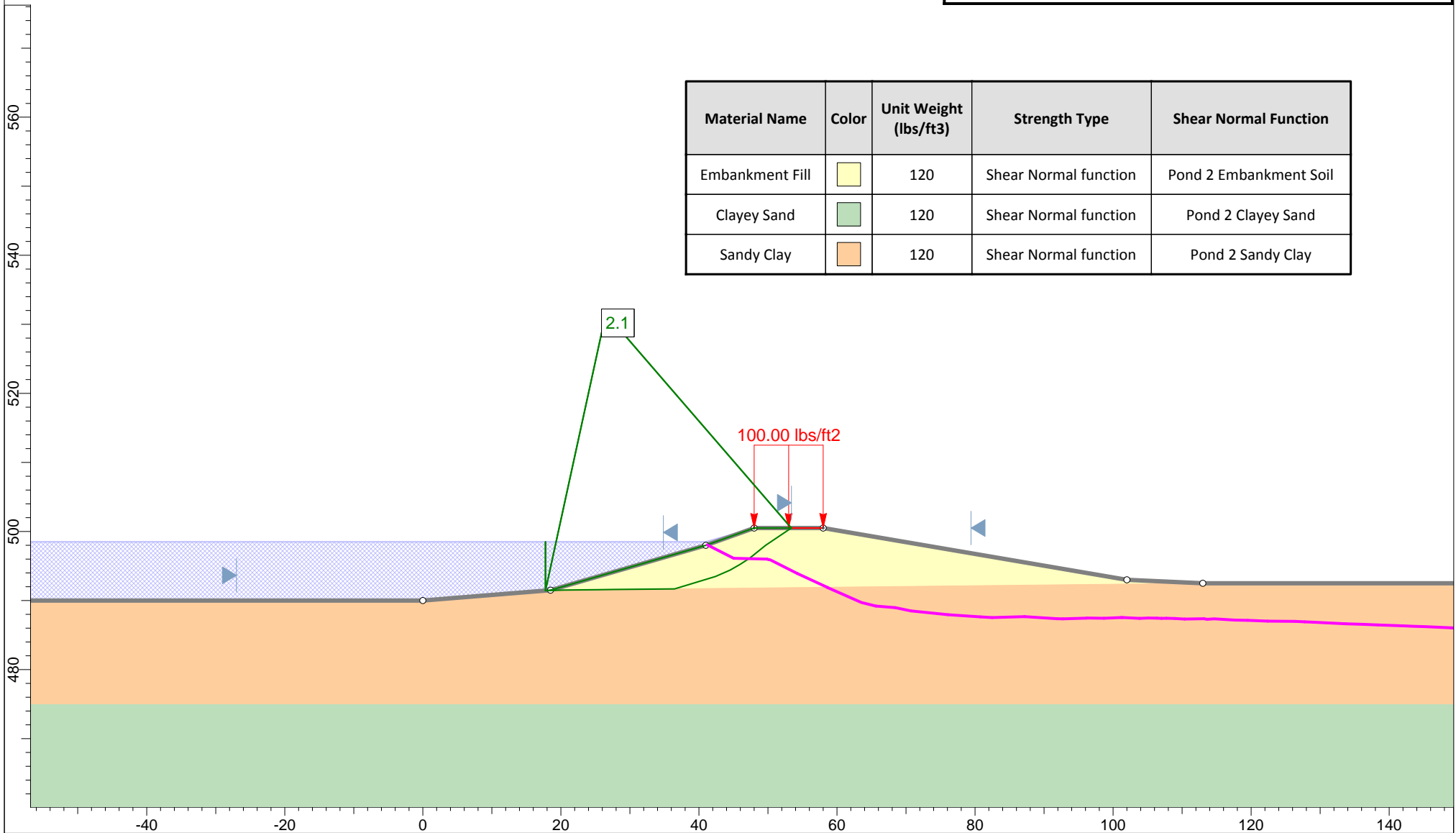



Profile "H" - Steady State
Ash Pond Berms - Spruce/Deely Generation Units

Raba Kistner Consultants, Inc.
ASA12-098-00

Figure C-9b



Global Stability Analysis

Material Name	Color	Unit Weight (lbs/ft ³)	Strength Type	Shear Normal Function
Embankment Fill		120	Shear Normal function	Pond 2 Embankment Soil
Clayey Sand		120	Shear Normal function	Pond 2 Clayey Sand
Sandy Clay		120	Shear Normal function	Pond 2 Sandy Clay

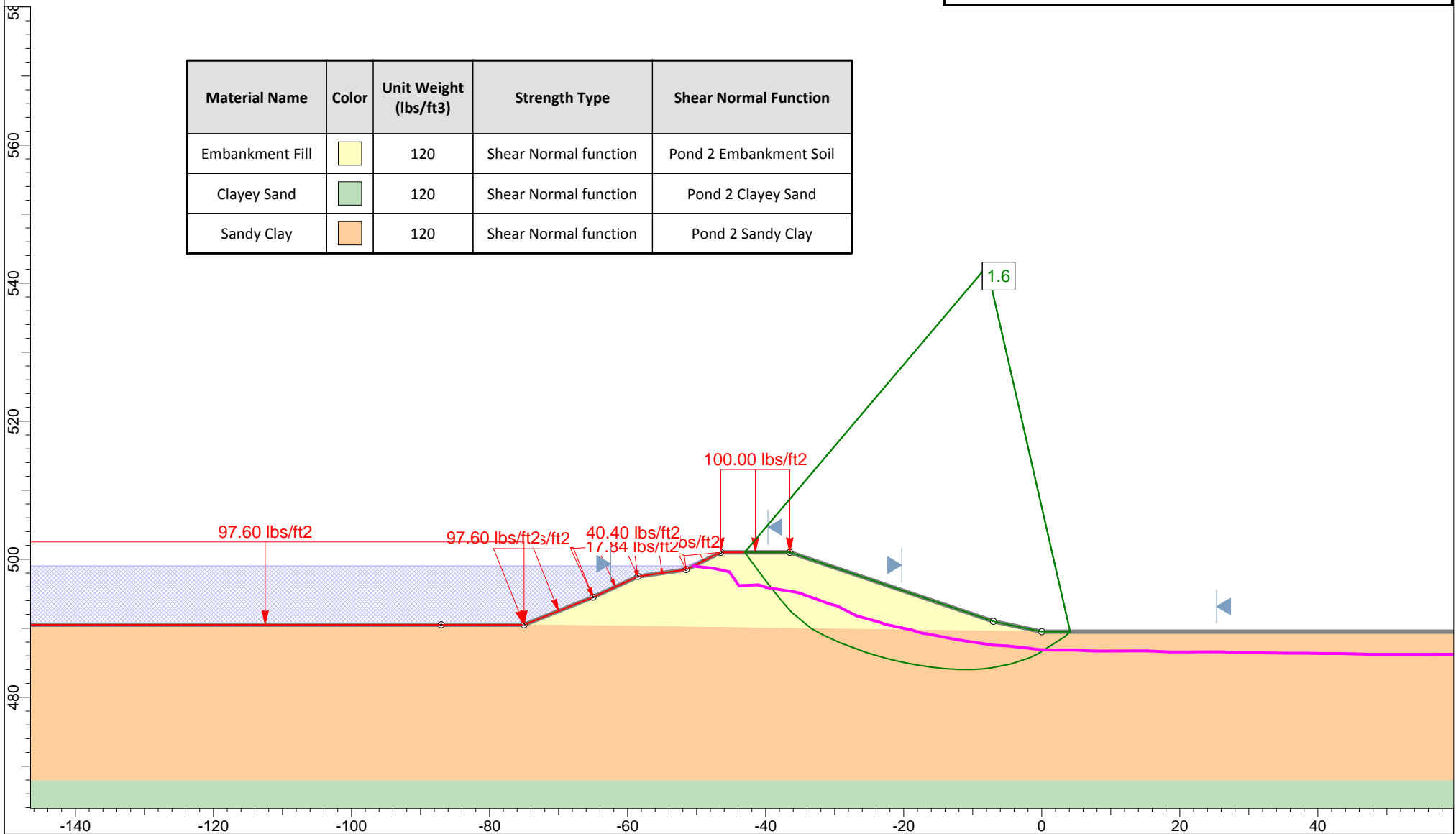



Profile "I" - Steady State
Ash Pond Berms - Spruce/Deely Generation Units

Raba Kistner Consultants, Inc.
ASA12-098-00

Figure C-10a



Global Stability Analysis

Material Name	Color	Unit Weight (lbs/ft ³)	Strength Type	Shear Normal Function
Embankment Fill		120	Shear Normal function	Pond 2 Embankment Soil
Clayey Sand		120	Shear Normal function	Pond 2 Clayey Sand
Sandy Clay		120	Shear Normal function	Pond 2 Sandy Clay

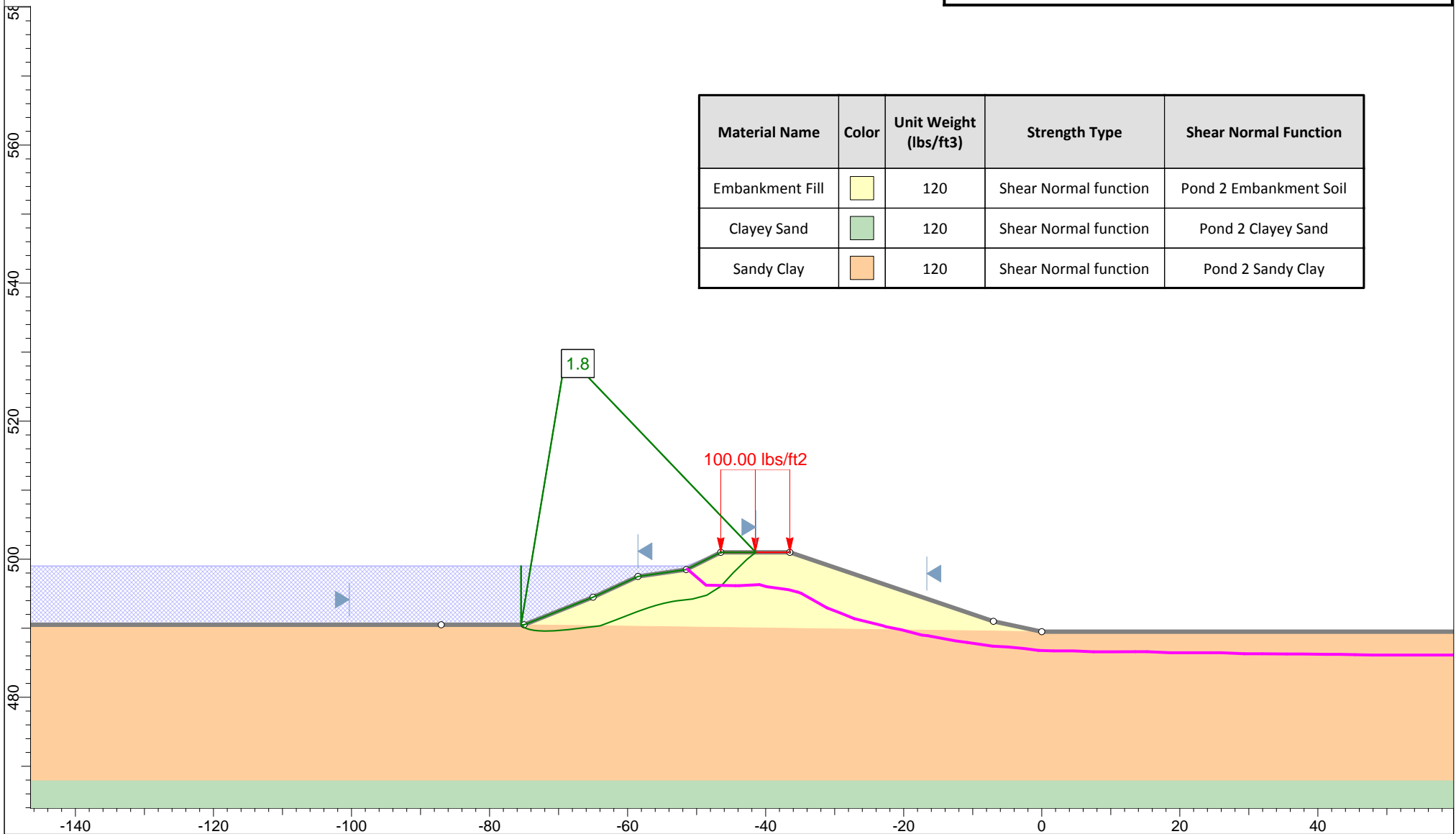



Profile "I" - Steady State
Ash Pond Berms - Spruce/Deely Generation Units

Raba Kistner Consultants, Inc.
ASA12-098-00

Figure C-10b



Global Stability Analysis

Material Name	Color	Unit Weight (lbs/ft ³)	Strength Type	Shear Normal Function
Embankment Fill		120	Shear Normal function	Pond 1 Embankment Soil
Clayey Sand		120	Shear Normal function	Pond 1 Clayey Sand

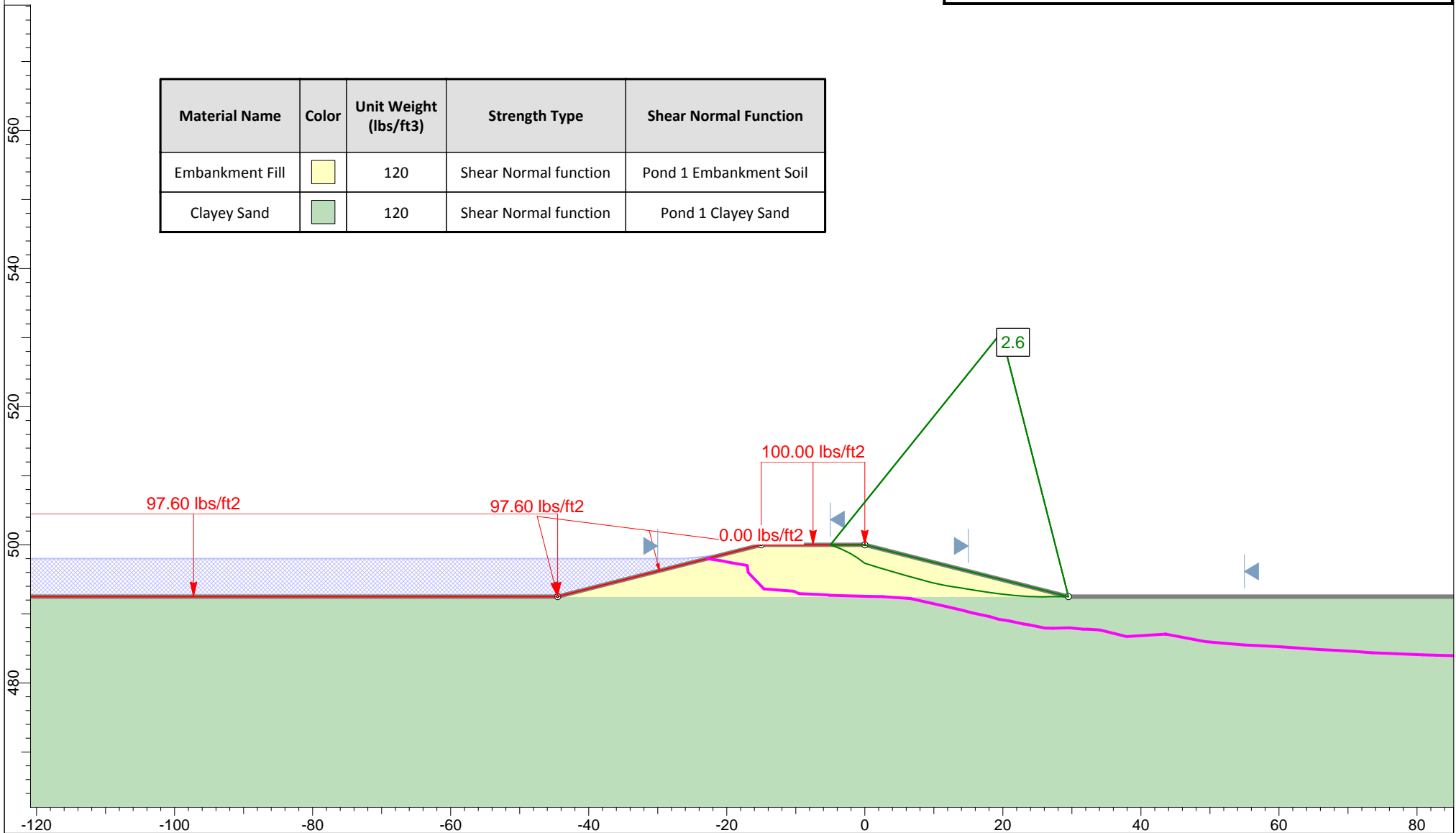



Profile "J" - Steady State
Ash Pond Berms - Spruce/Deely Generation Units

Raba Kistner Consultants, Inc.
ASA12-098-00

Figure C-11a



Global Stability Analysis

Material Name	Color	Unit Weight (lbs/ft ³)	Strength Type	Shear Normal Function
Embankment Fill		120	Shear Normal function	Pond 1 Embankment Soil
Clayey Sand		120	Shear Normal function	Pond 1 Clayey Sand

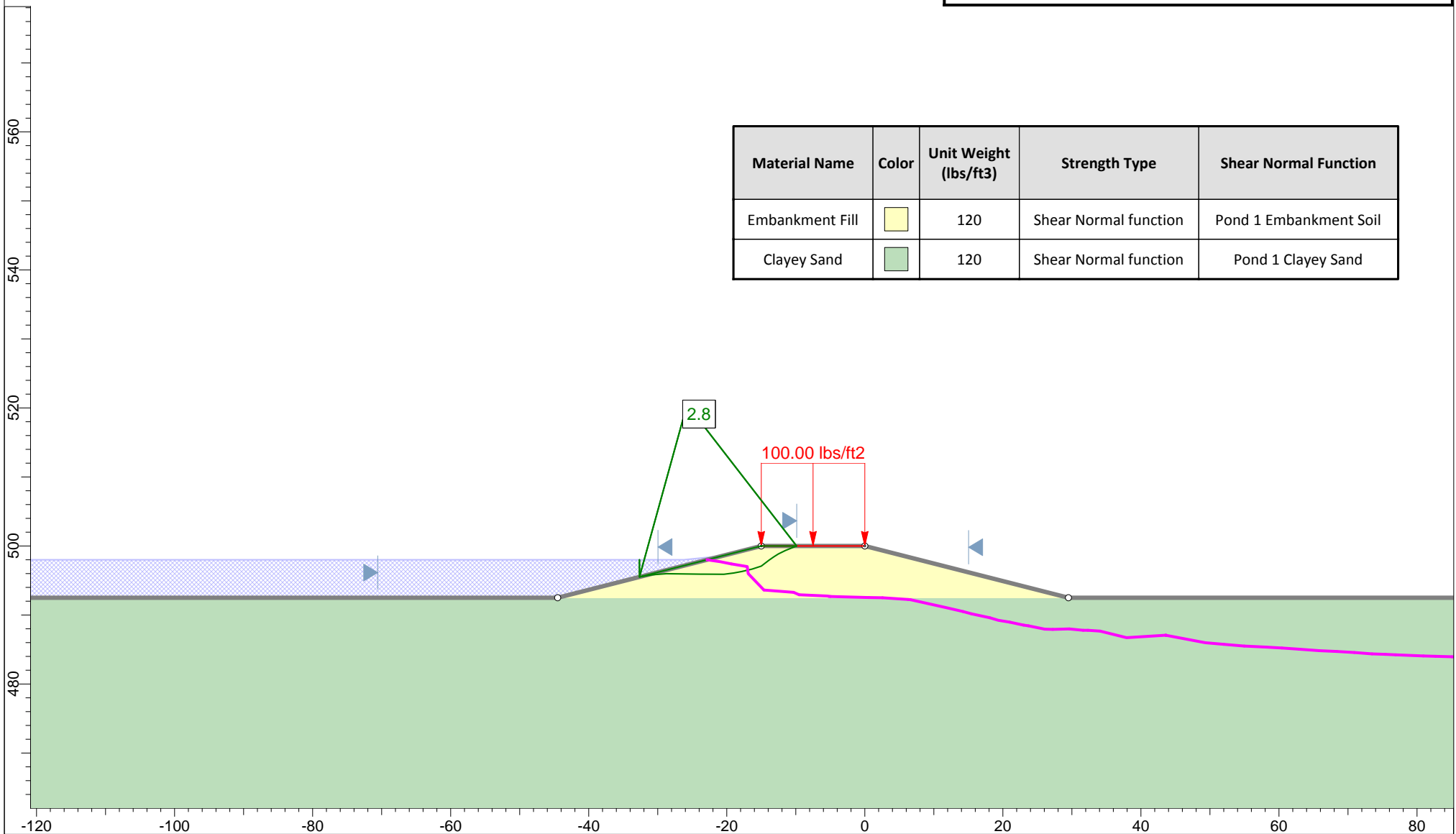



Profile "J" - Steady State
Ash Pond Berms - Spruce/Deely Generation Units

Raba Kistner Consultants, Inc.
ASA12-098-00

Figure C-11b



Global Stability Analysis

Material Name	Color	Unit Weight (lbs/ft ³)	Strength Type	Shear Normal Function
Embankment Fill		120	Shear Normal function	Pond 1 Embankment Soil
Sandy Clay		120	Shear Normal function	Pond 1 Sandy Clay

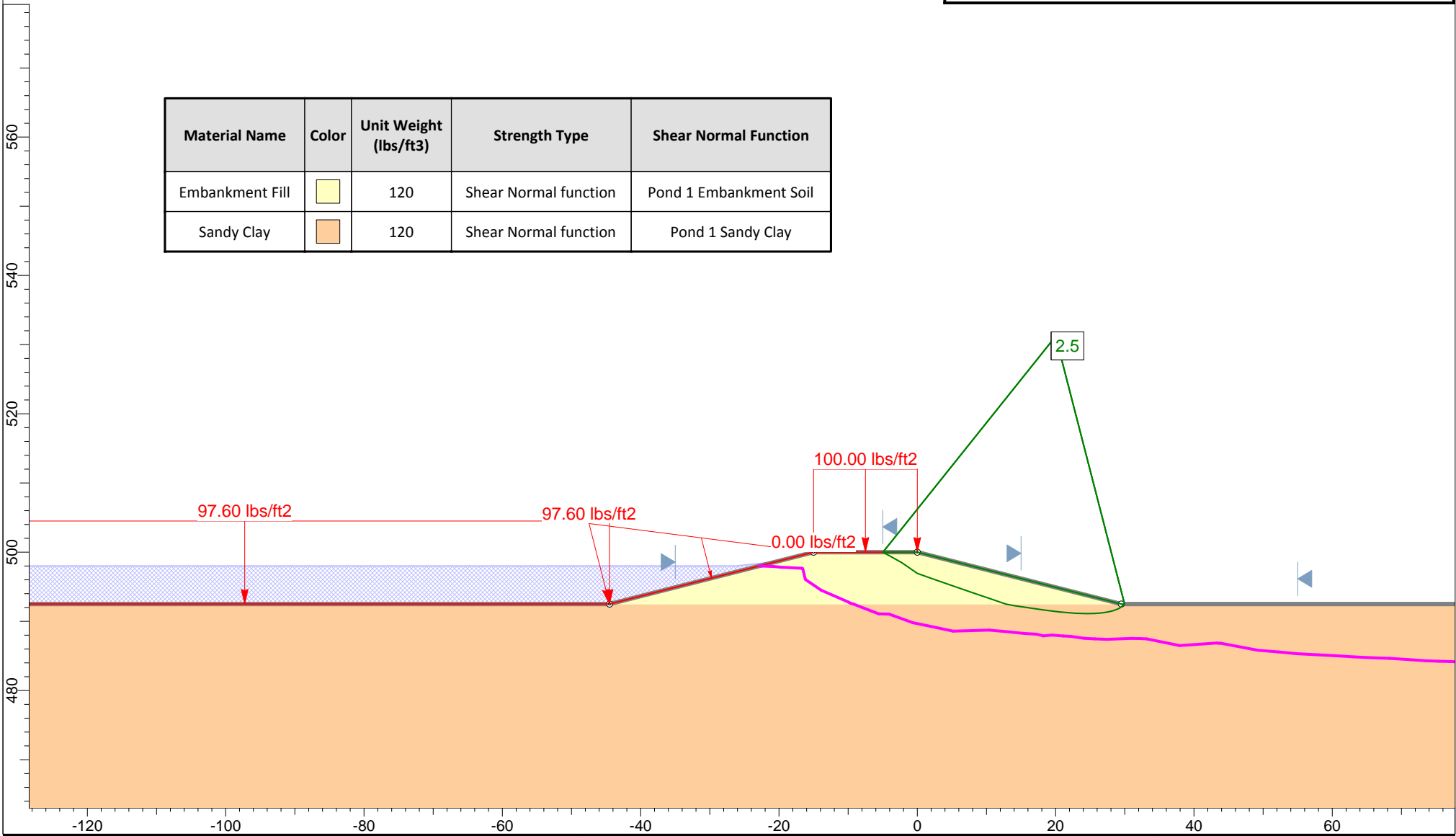

Profile "K" - Steady State
 Ash Pond Berms - Spruce/Deely Generation Units

Raba Kistner Consultants, Inc.
 ASA12-098-00

Figure C-12a



Global Stability Analysis

Material Name	Color	Unit Weight (lbs/ft ³)	Strength Type	Shear Normal Function
Embankment Fill		120	Shear Normal function	Pond 1 Embankment Soil
Sandy Clay		120	Shear Normal function	Pond 1 Sandy Clay

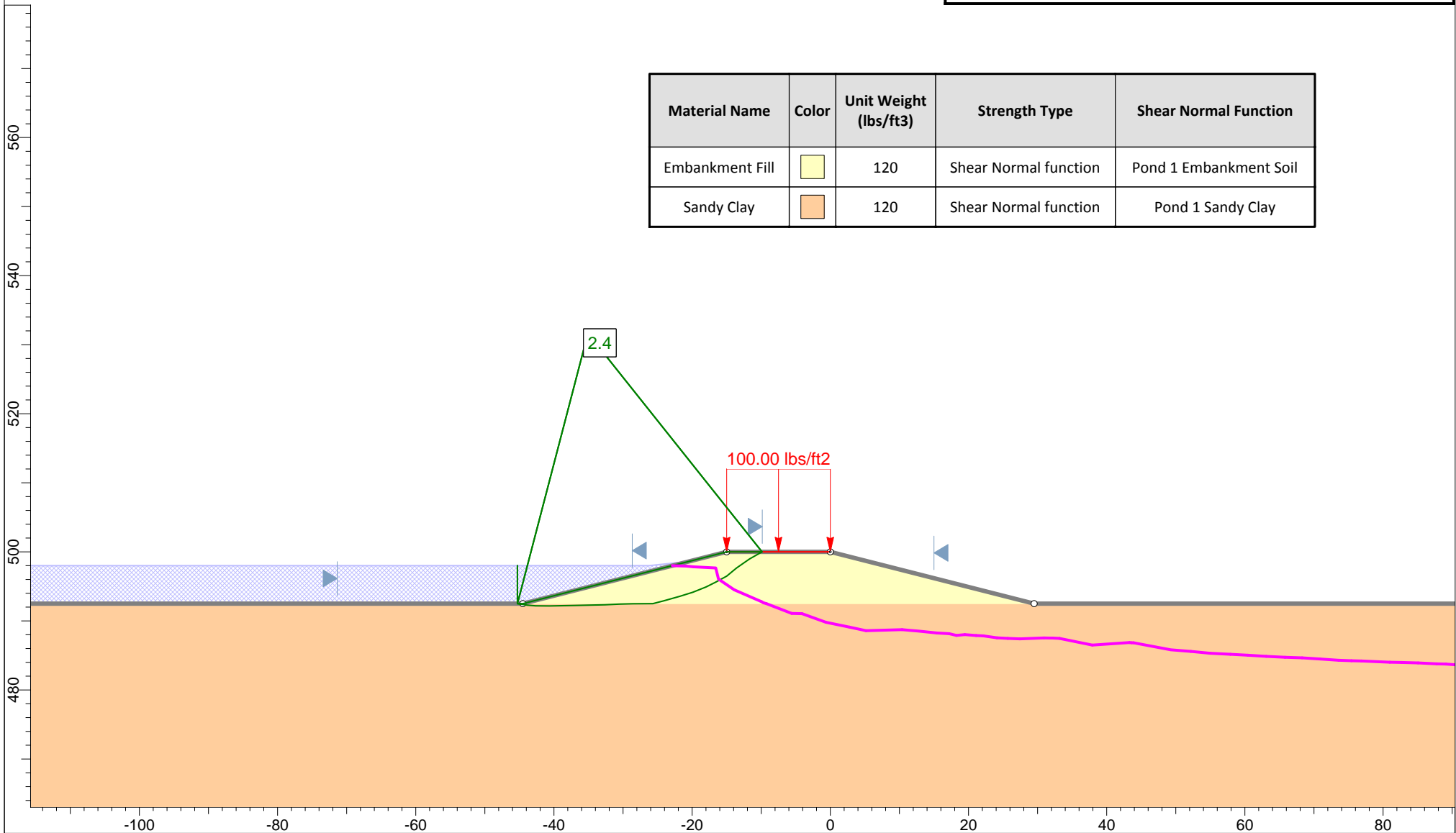



Profile "K" - Steady State
Ash Pond Berms - Spruce/Deely Generation Units

Raba Kistner Consultants, Inc.
ASA12-098-00

Figure C-12b



Global Stability Analysis

Material Name	Color	Unit Weight (lbs/ft ³)	Strength Type	Shear Normal Function
Embankment Fill		120	Shear Normal function	Pond 1 Embankment Soil
Clayey Sand		120	Shear Normal function	Pond 1 Clayey Sand
Sandy Clay		120	Shear Normal function	Pond 1 Sandy Clay

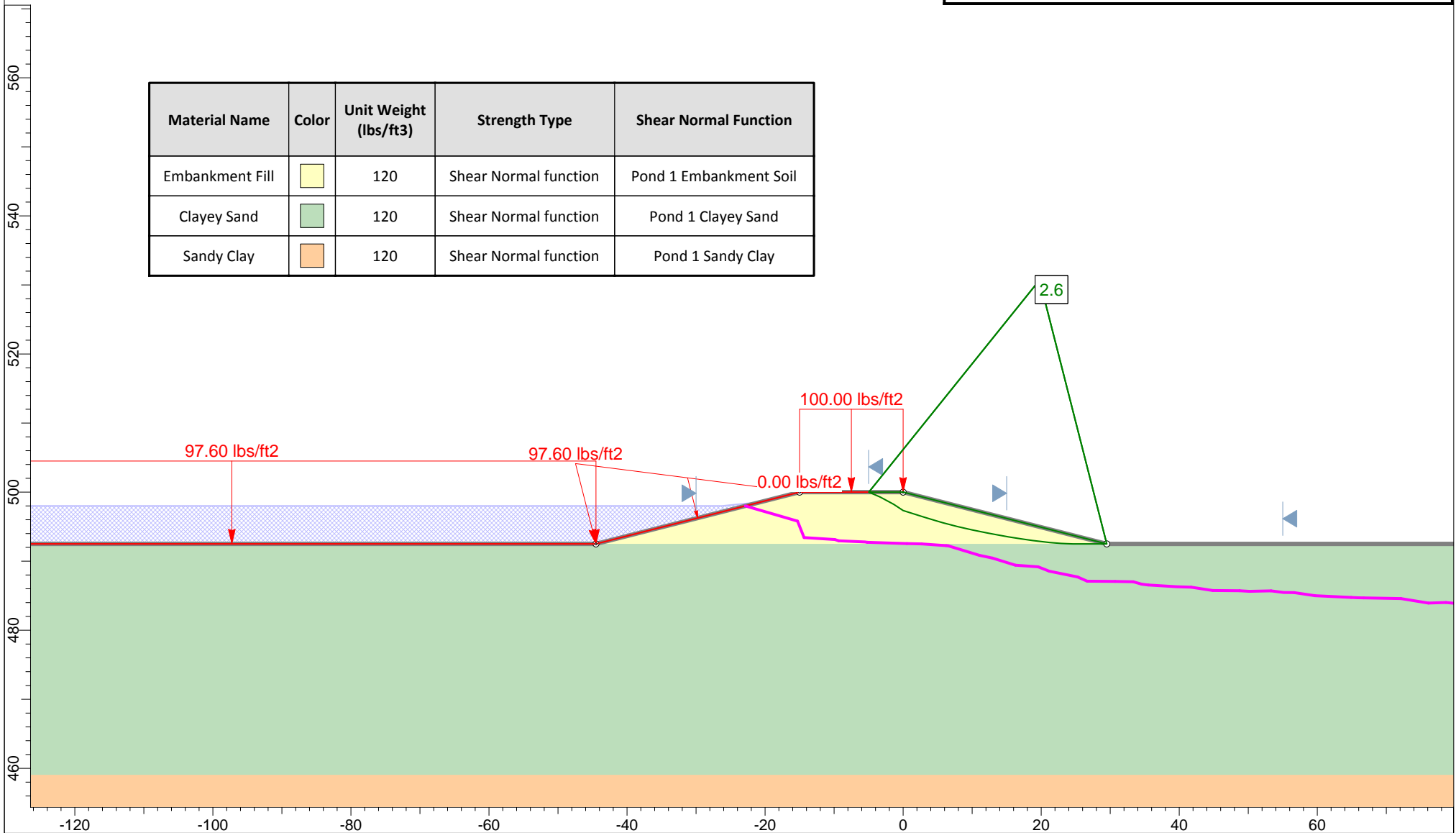



Profile "L" - Steady State
Ash Pond Berms - Spruce/Deely Generation Units

Raba Kistner Consultants, Inc.
ASA12-098-00

Figure C-13a



Global Stability Analysis

Material Name	Color	Unit Weight (lbs/ft ³)	Strength Type	Shear Normal Function
Embankment Fill		120	Shear Normal function	Pond 1 Embankment Soil
Clayey Sand		120	Shear Normal function	Pond 1 Clayey Sand
Sandy Clay		120	Shear Normal function	Pond 1 Sandy Clay

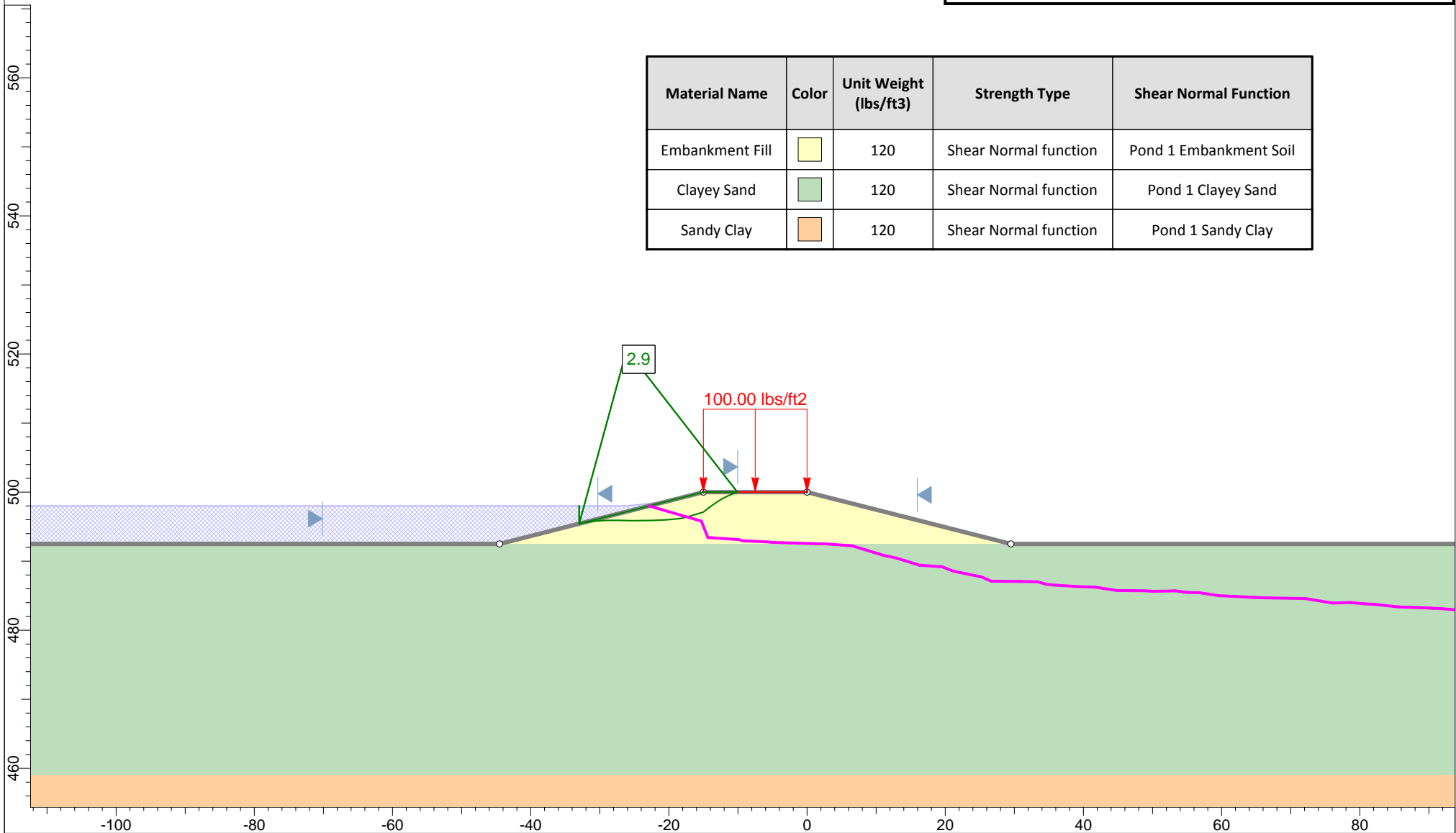



Profile "L" - Steady State
Ash Pond Berms - Spruce/Deely Generation Units

Raba Kistner Consultants, Inc.
ASA12-098-00

Figure C-13b



Global Stability Analysis

Material Name	Color	Unit Weight (lbs/ft ³)	Strength Type	Shear Normal Function
Embankment Fill		120	Shear Normal function	Pond 1 Embankment Soil
Clayey Sand		120	Shear Normal function	Pond 1 Clayey Sand
Sandy Clay		120	Shear Normal function	Pond 1 Sandy Clay

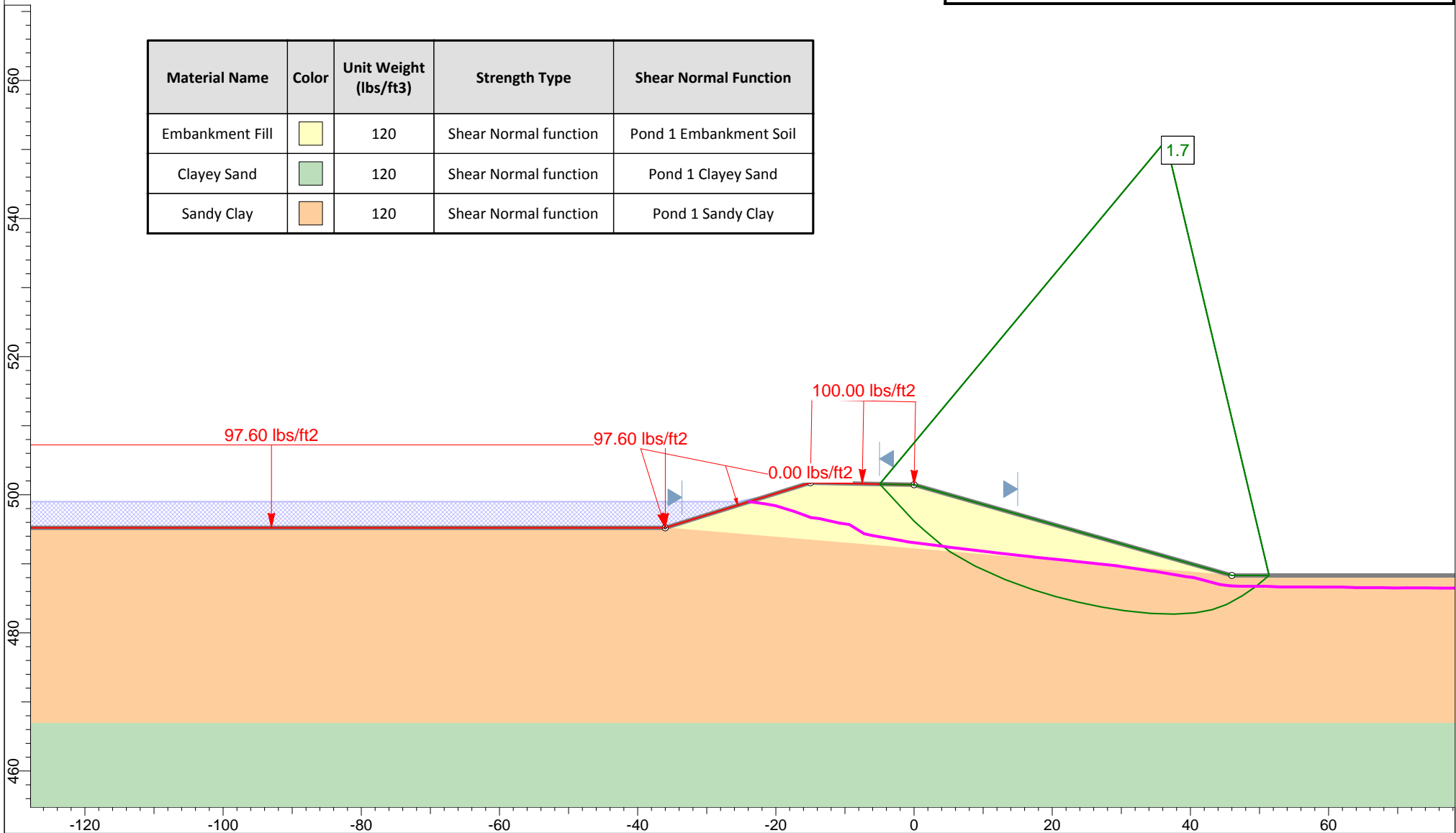

Profile "M" - Steady State
Ash Pond Berms - Spruce/Deely Generation Units

Raba Kistner Consultants, Inc.
ASA12-098-00

Figure C-14a



Global Stability Analysis

Material Name	Color	Unit Weight (lbs/ft3)	Strength Type	Shear Normal Function
Embankment Fill	Yellow	120	Shear Normal function	Pond 1 Embankment Soil
Clayey Sand	Green	120	Shear Normal function	Pond 1 Clayey Sand
Sandy Clay	Orange	120	Shear Normal function	Pond 1 Sandy Clay

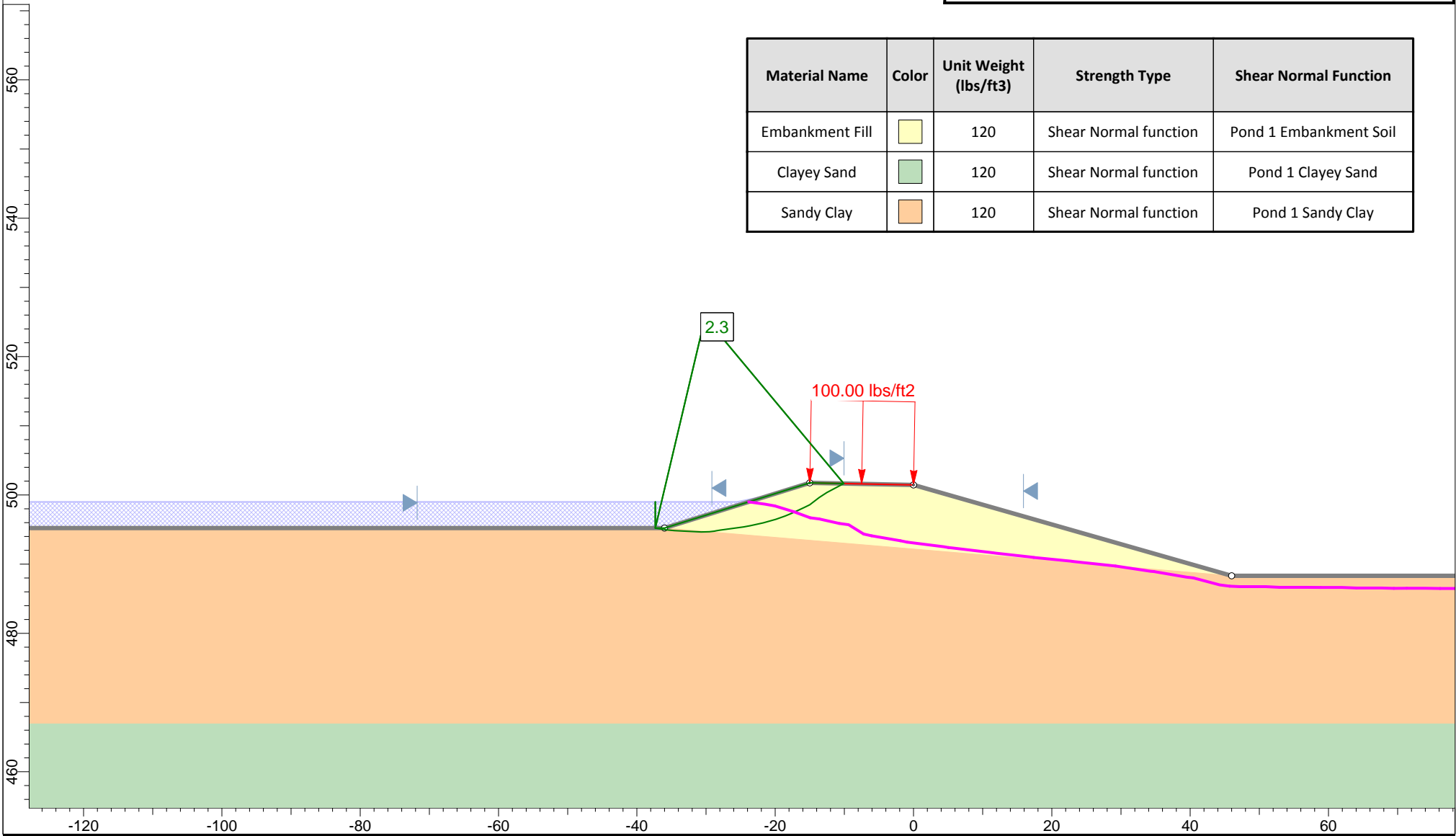

Profile "M" - Steady State
 Ash Pond Berms - Spruce/Deely Generation Units

Raba Kistner Consultants, Inc.
 ASA12-098-00

Figure C-14b

Global Stability Analysis

Material Name	Color	Unit Weight (lbs/ft ³)	Strength Type	Shear Normal Function
Embankment Fill		120	Shear Normal function	Pond 2 Embankment Soil
Clayey Sand		120	Shear Normal function	Pond 2 Clayey Sand

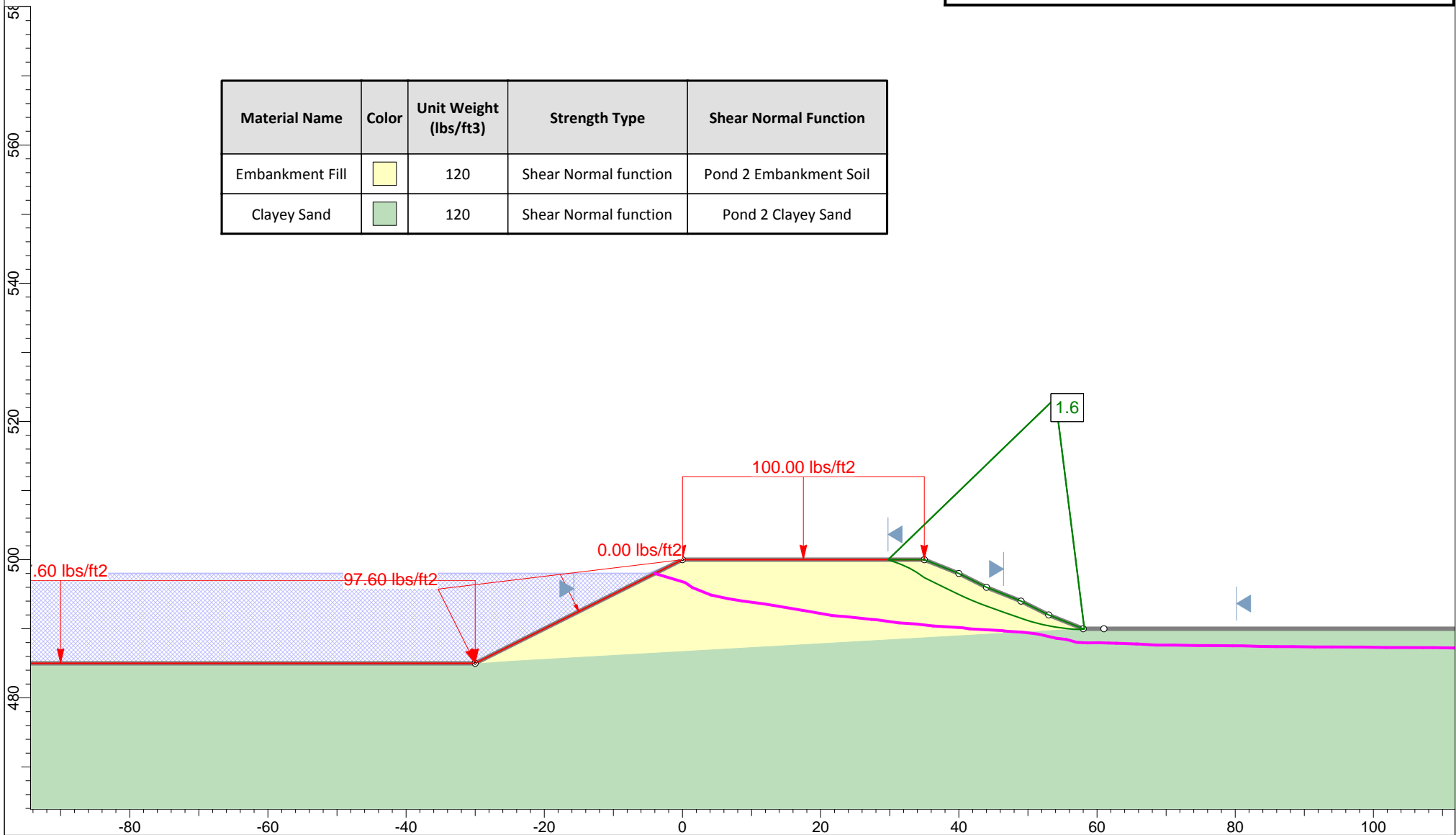



Profile "N" - Steady State
Ash Pond Berms - Spruce/Deely Generation Units

Raba Kistner Consultants, Inc.
ASA12-098-00

Figure C-15a



Global Stability Analysis

Material Name	Color	Unit Weight (lbs/ft ³)	Strength Type	Shear Normal Function
Embankment Fill		120	Shear Normal function	Pond 2 Embankment Soil
Clayey Sand		120	Shear Normal function	Pond 2 Clayey Sand

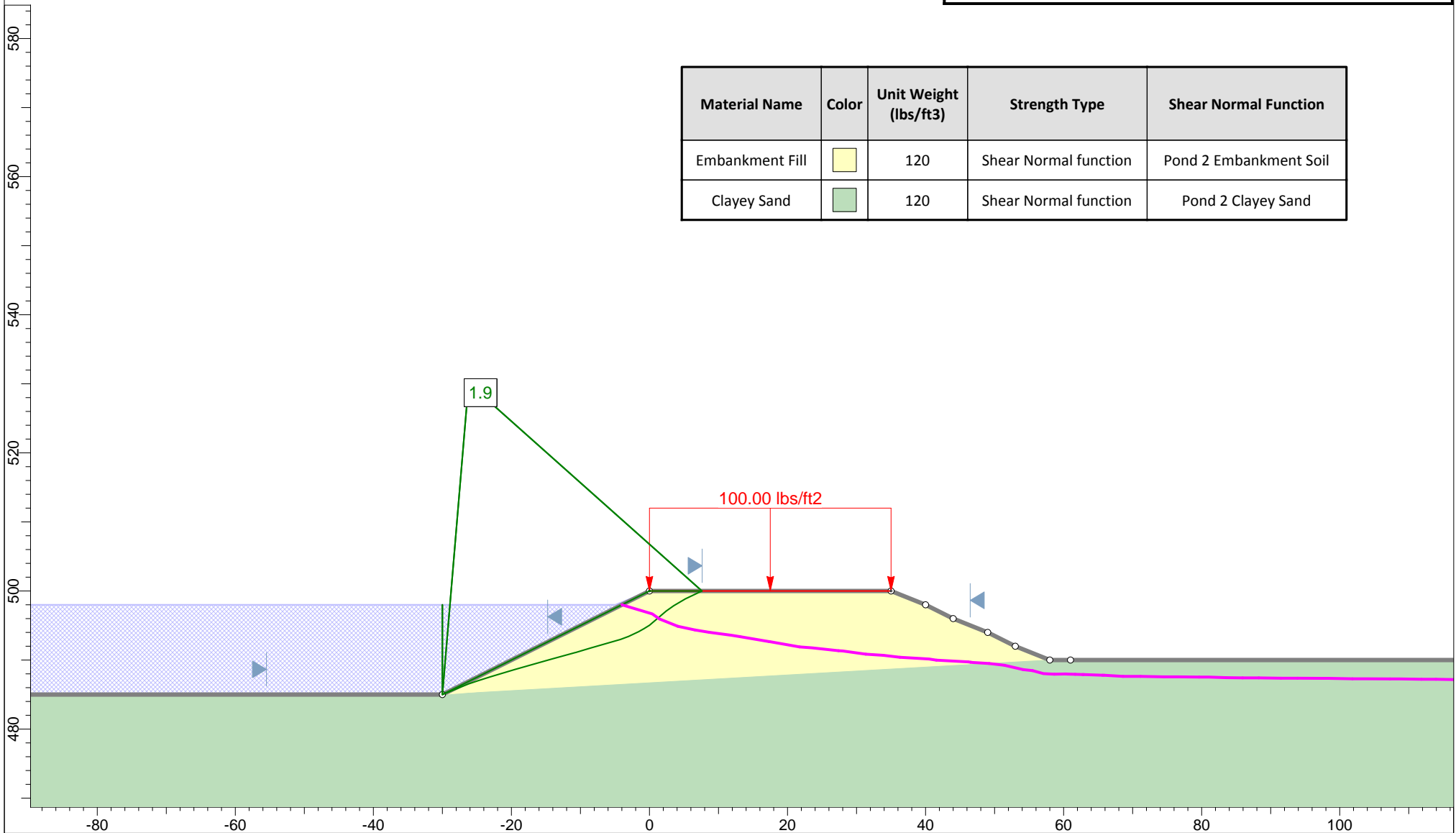



Profile "N" - Steady State
Ash Pond Berms - Spruce/Deely Generation Units

Raba Kistner Consultants, Inc.
ASA12-098-00

Figure C-15b



Global Stability Analysis

Material Name	Color	Unit Weight (lbs/ft ³)	Strength Type	Shear Normal Function
Embankment Fill		120	Shear Normal function	Pond 3 Embankment Soil
Clayey Sand		120	Shear Normal function	Pond 3 Clayey Sand

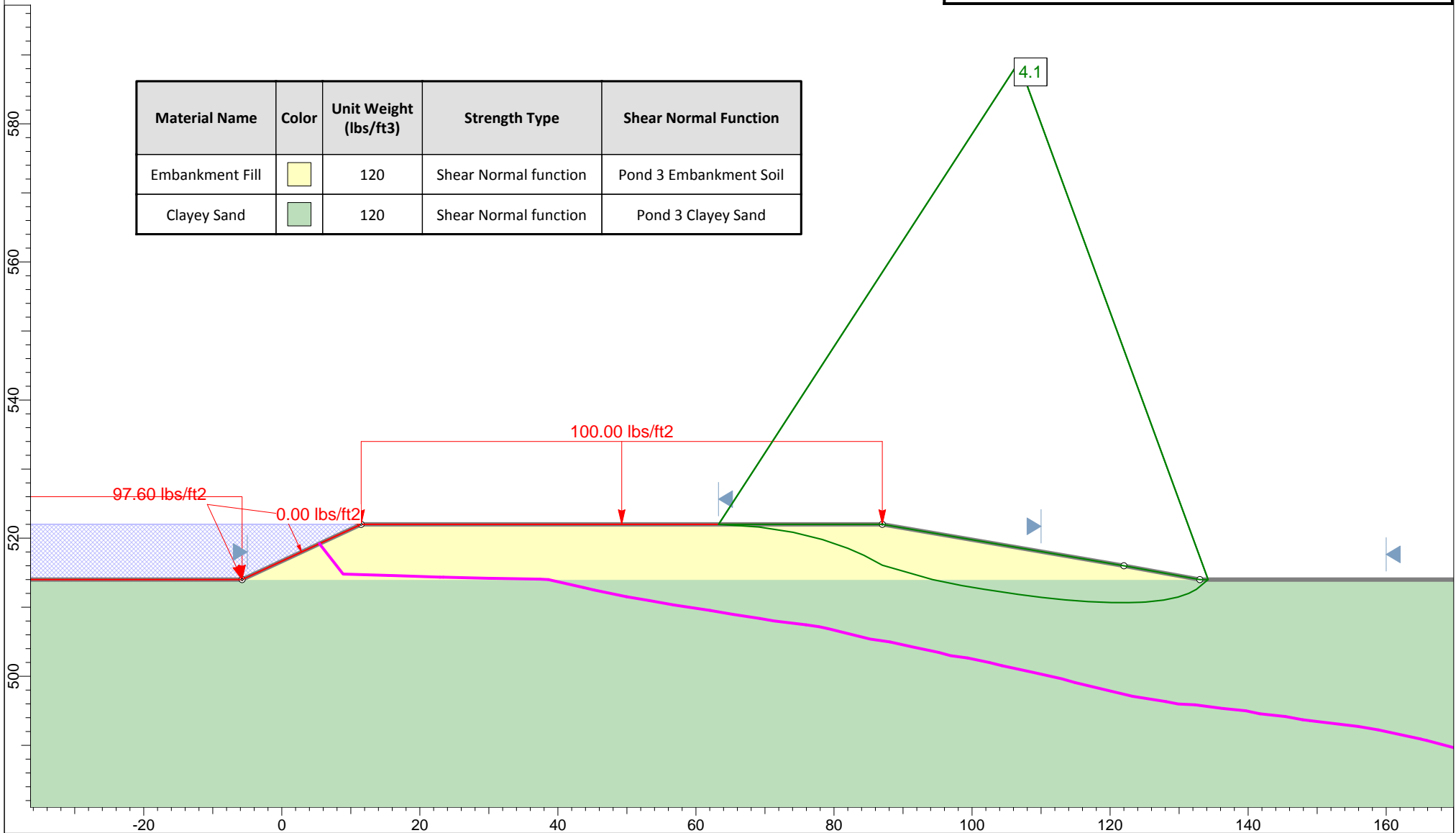



Profile "A" - Maximum Pool
Ash Pond Berms - Spruce/Deely Generation Units

Raba Kistner Consultants, Inc.
ASA12-098-00

Figure C-16a



Global Stability Analysis

Material Name	Color	Unit Weight (lbs/ft3)	Strength Type	Shear Normal Function
Embankment Fill		120	Shear Normal function	Pond 3 Embankment Soil
Clayey Sand		120	Shear Normal function	Pond 3 Clayey Sand

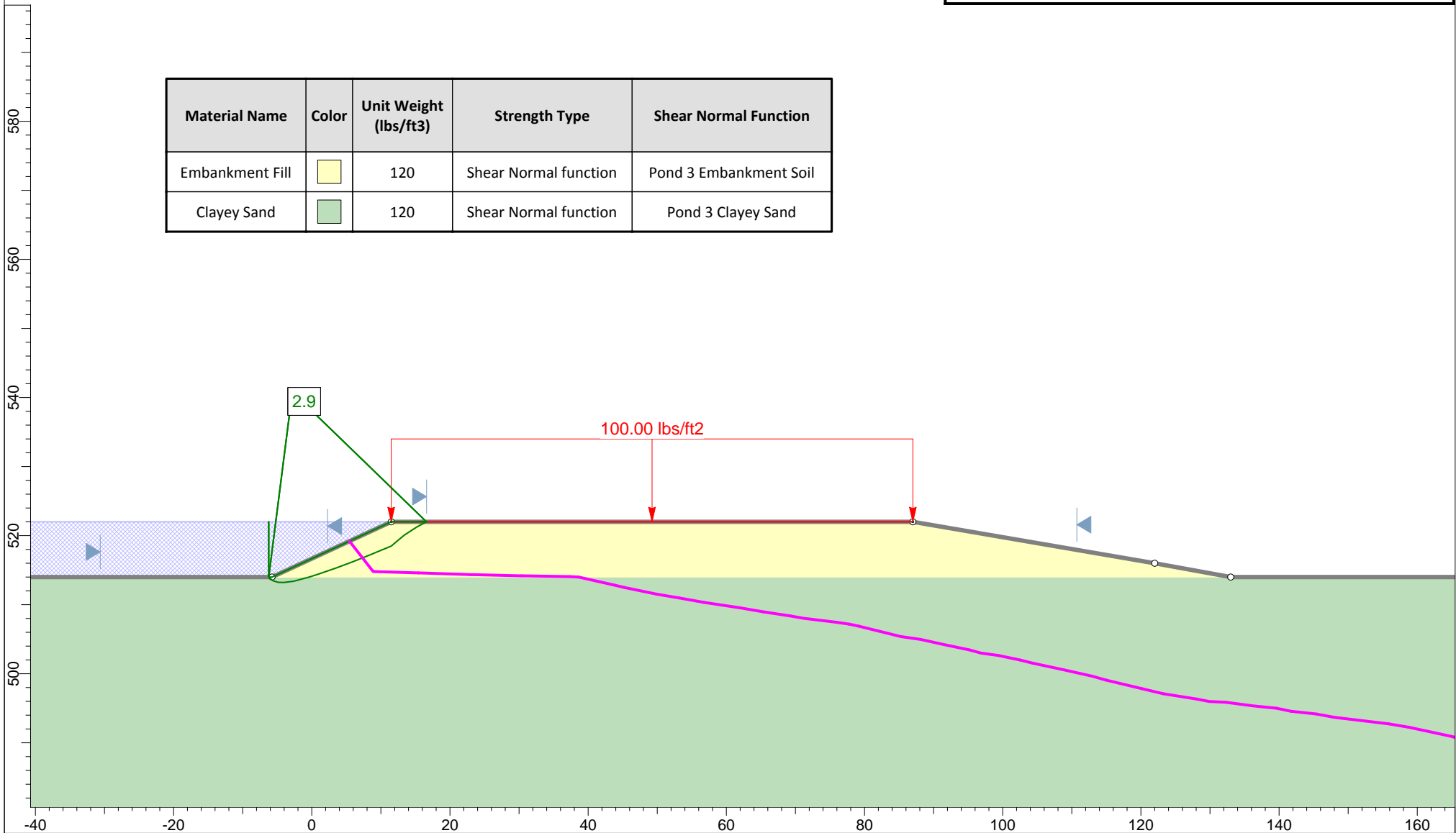



Profile "A" - Maximum Pool
Ash Pond Berms - Spruce/Deely Generation Units

Raba Kistner Consultants, Inc.
ASA12-098-00

Figure C-16b



Global Stability Analysis

Material Name	Color	Unit Weight (lbs/ft ³)	Strength Type	Shear Normal Function
Embankment Fill		120	Shear Normal function	Pond 3 Embankment Soil
Clayey Sand		120	Shear Normal function	Pond 3 Clayey Sand
Sandy Clay		120	Shear Normal function	Pond 3 Sandy Clay

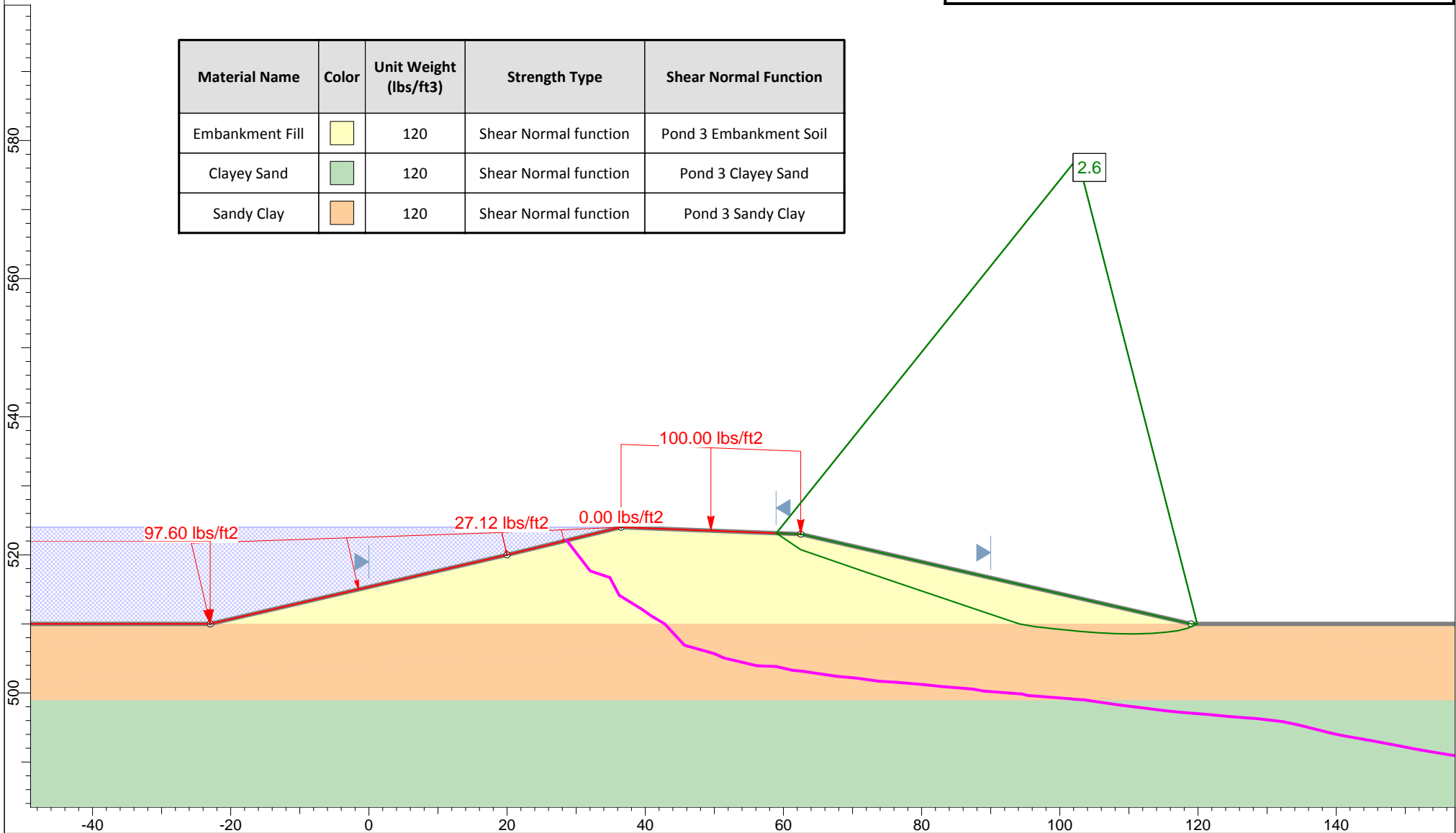



Profile "B" - Maximum Pool
Ash Pond Berms - Spruce/Deely Generation Units

Raba Kistner Consultants, Inc.
ASA12-098-00

Figure C-17a



Global Stability Analysis

Material Name	Color	Unit Weight (lbs/ft ³)	Strength Type	Shear Normal Function
Embankment Fill		120	Shear Normal function	Pond 3 Embankment Soil
Clayey Sand		120	Shear Normal function	Pond 3 Clayey Sand
Sandy Clay		120	Shear Normal function	Pond 3 Sandy Clay

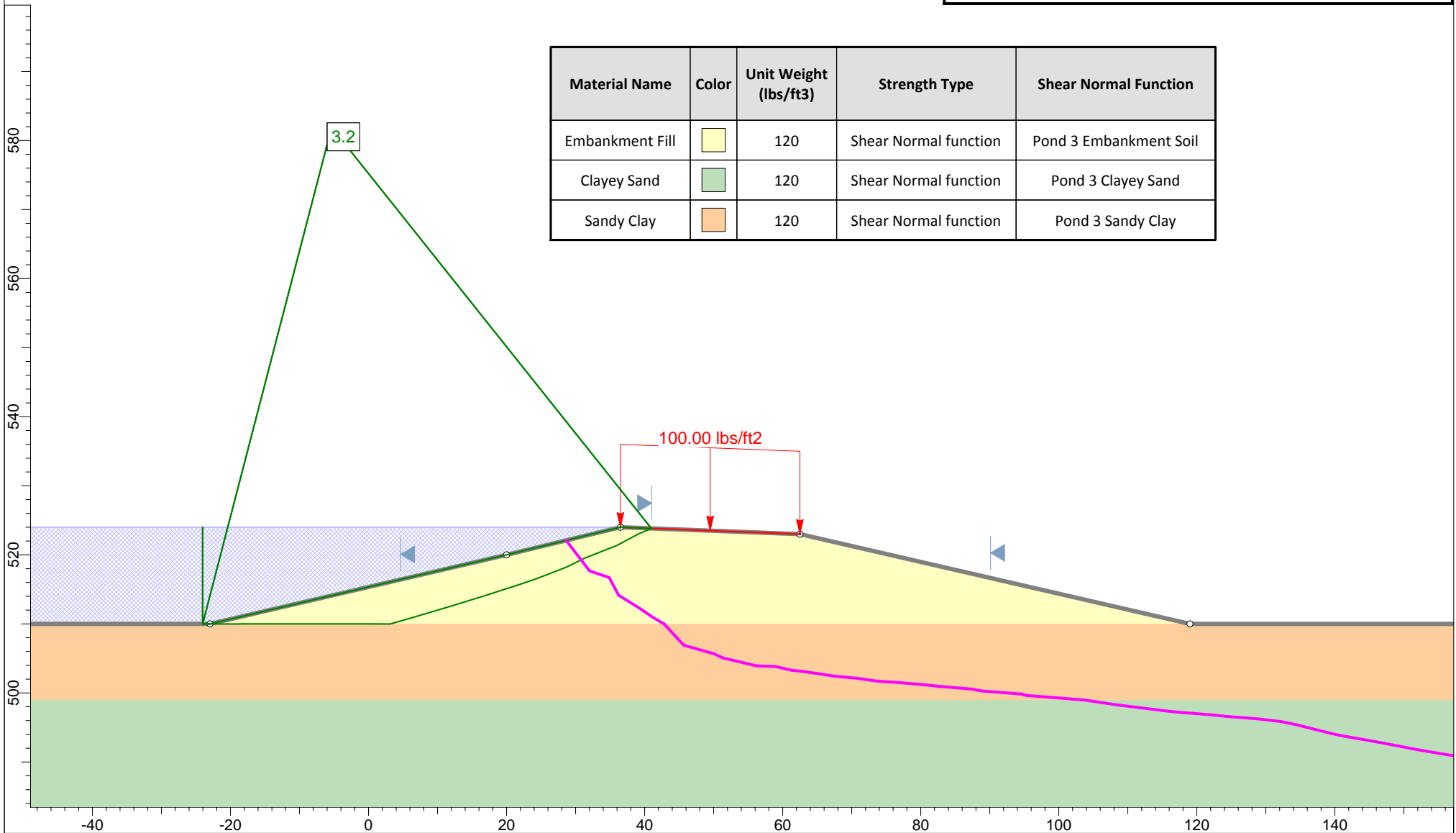

Profile "B" - Maximum Pool
Ash Pond Berms - Spruce/Deely Generation Units

Raba Kistner Consultants, Inc.
ASA12-098-00

Figure C-17b



Global Stability Analysis

Material Name	Color	Unit Weight (lbs/ft ³)	Strength Type	Shear Normal Function
Embankment Fill	Yellow	120	Shear Normal function	Pond 3 Embankment Soil
Clayey Sand	Green	120	Shear Normal function	Pond 3 Clayey Sand

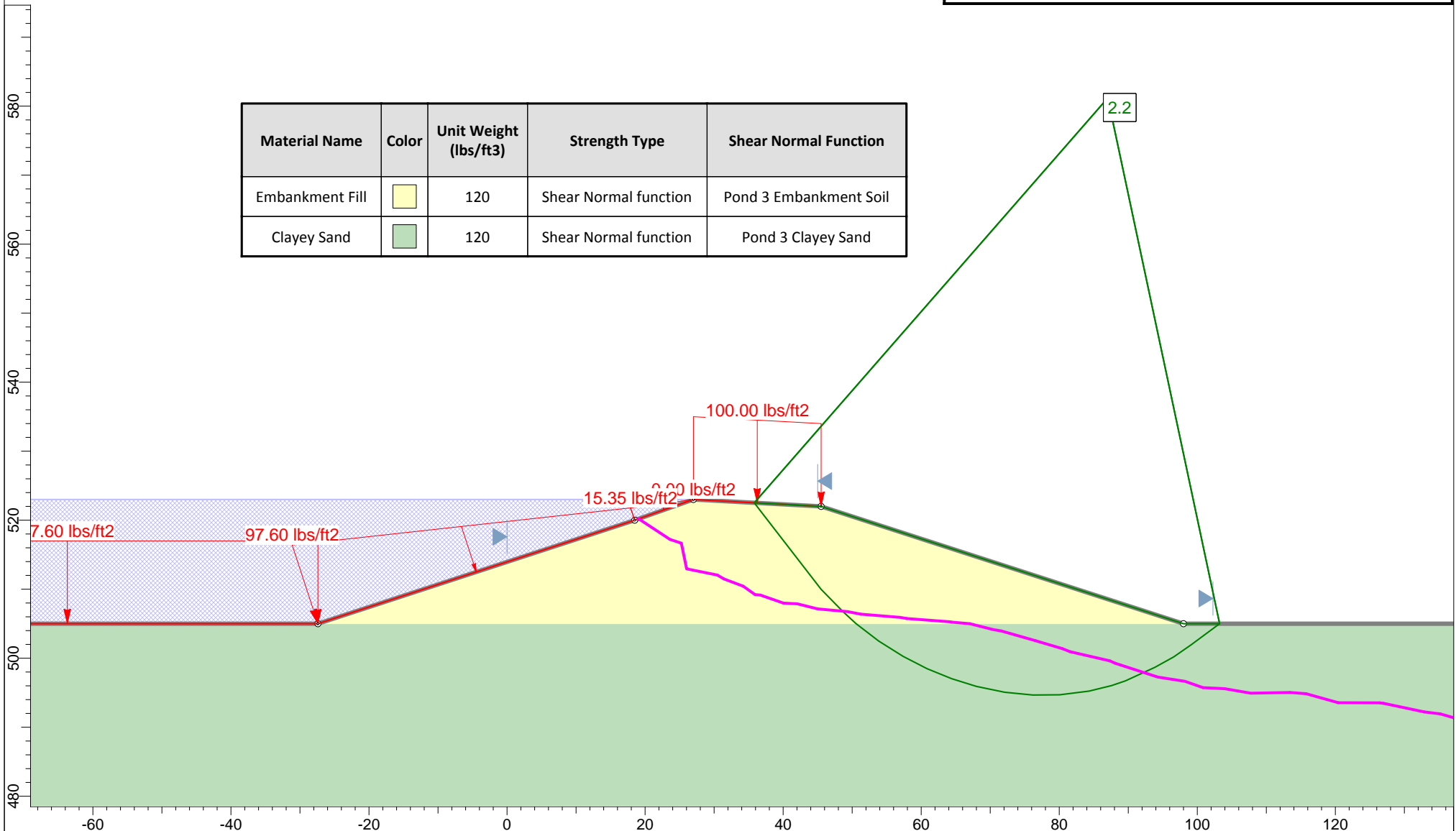

Profile "C" - Maximum Pool
Ash Pond Berms - Spruce/Deely Generation Units

Raba Kistner Consultants, Inc.
ASA12-098-00

Figure C-18a



Global Stability Analysis

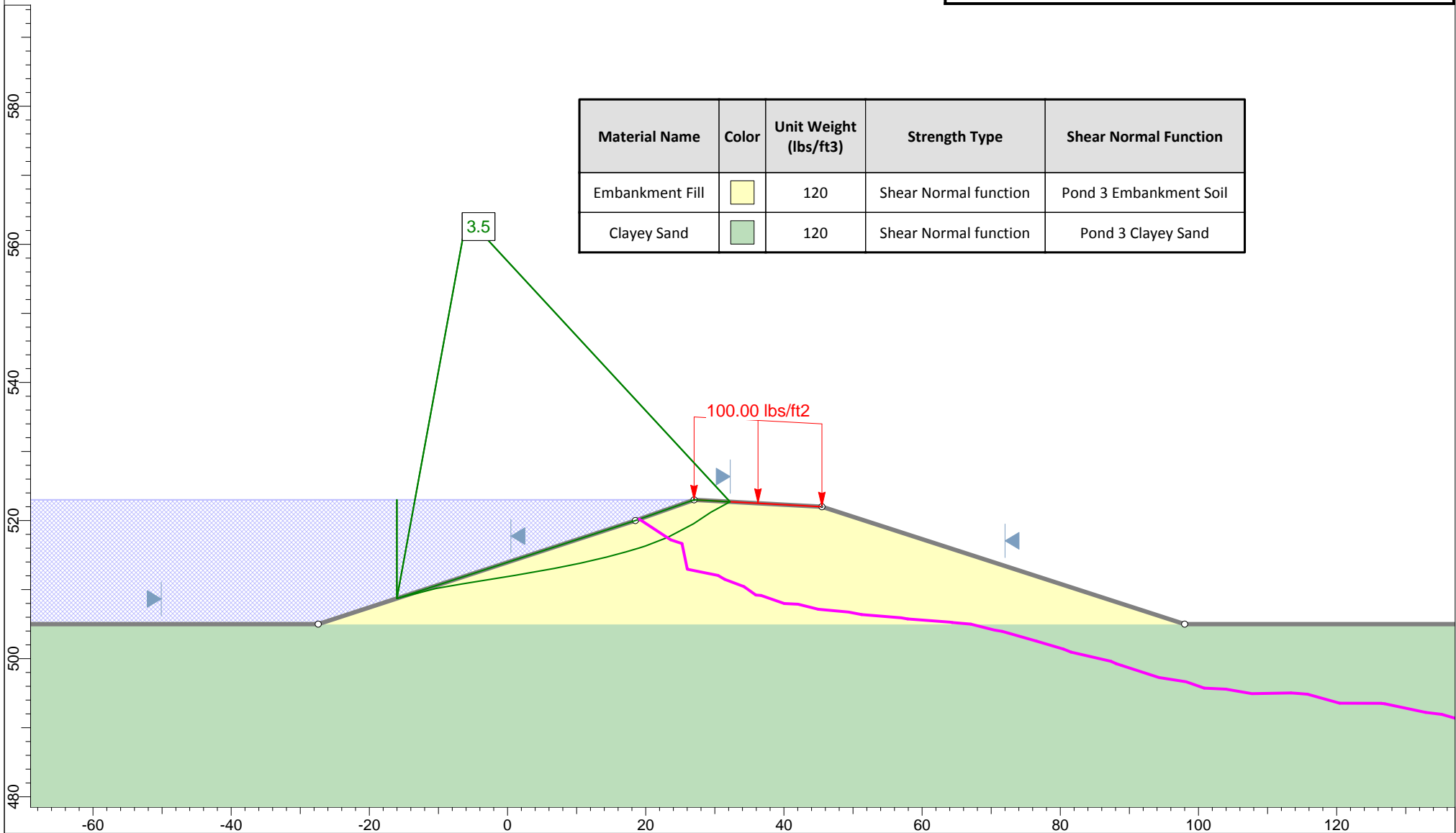



Profile "C" - Maximum Pool
Ash Pond Berms - Spruce/Deely Generation Units

Raba Kistner Consultants, Inc.
ASA12-098-00

Figure C-18b



Global Stability Analysis

Material Name	Color	Unit Weight (lbs/ft ³)	Strength Type	Shear Normal Function
Embankment Fill		120	Shear Normal function	Pond 3 Embankment Soil
Clayey Sand		120	Shear Normal function	Pond 3 Clayey Sand
Sandy Clay		120	Shear Normal function	Pond 3 Sandy Clay

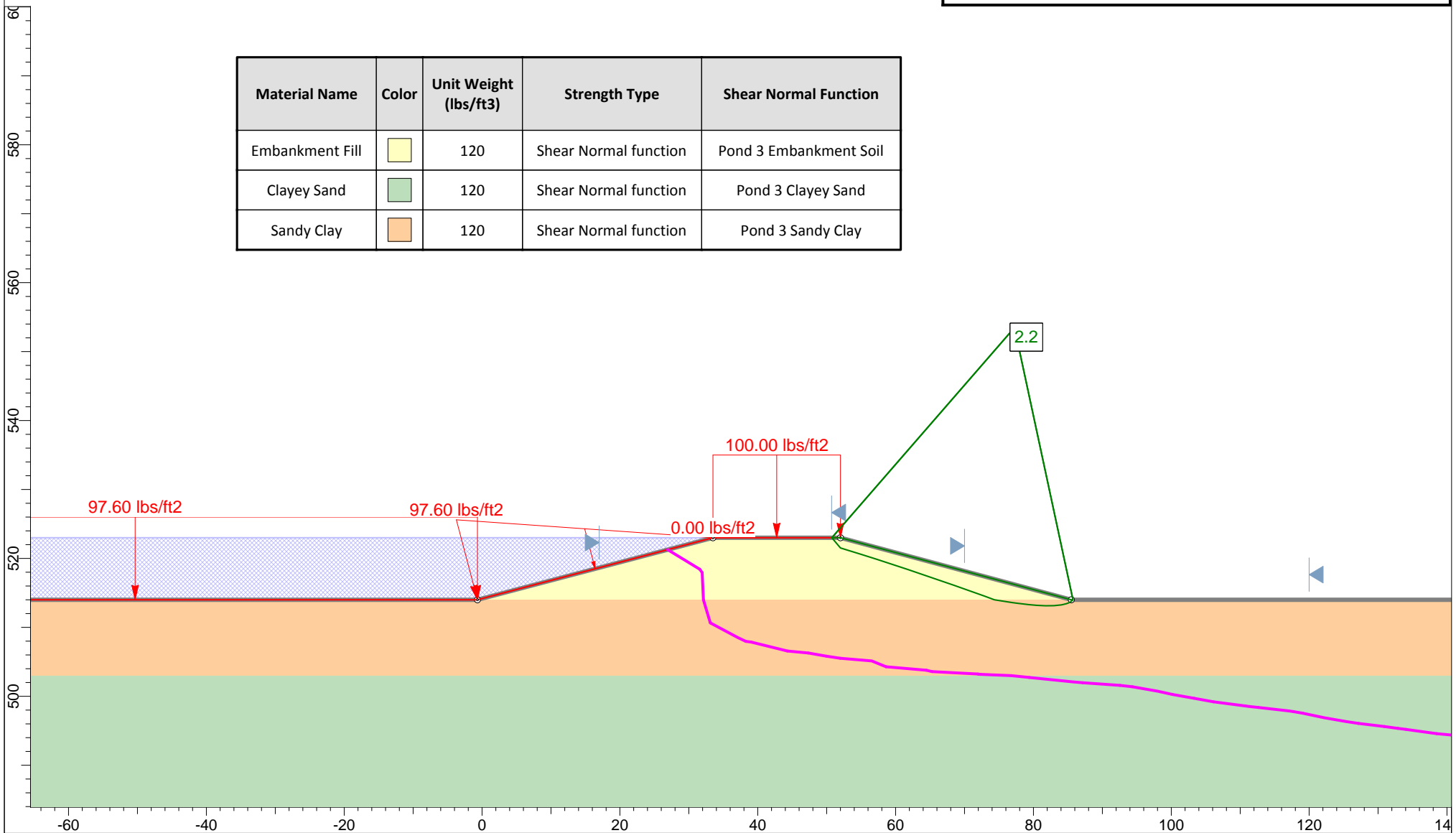

Profile "D" - Maximum Pool
Ash Pond Berms - Spruce/Deely Generation Units

Raba Kistner Consultants, Inc.
ASA12-098-00

Figure C-19a



Global Stability Analysis

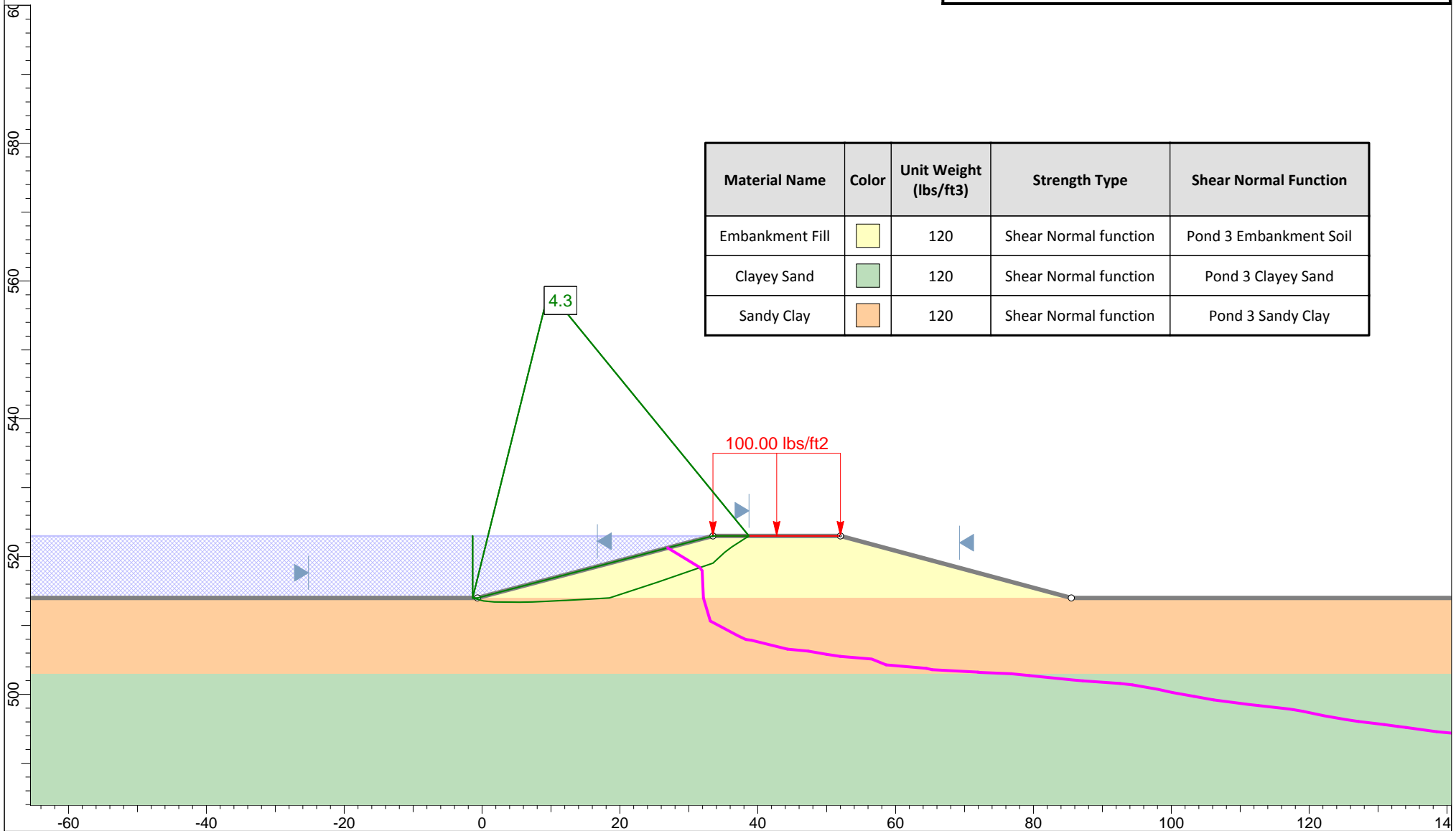

Material Name	Color	Unit Weight (lbs/ft ³)	Strength Type	Shear Normal Function
Embankment Fill		120	Shear Normal function	Pond 3 Embankment Soil
Clayey Sand		120	Shear Normal function	Pond 3 Clayey Sand
Sandy Clay		120	Shear Normal function	Pond 3 Sandy Clay



Profile "D" - Maximum Pool
Ash Pond Berms - Spruce/Deely Generation Units

Raba Kistner Consultants, Inc.
ASA12-098-00

Figure C-19b



Global Stability Analysis

Material Name	Color	Unit Weight (lbs/ft ³)	Strength Type	Shear Normal Function
Embankment Soil		120	Shear Normal function	Pond 2 Embankment Soil
Clayey Sand		120	Shear Normal function	Pond 2 Clayey Sand
Sandy Clay		120	Shear Normal function	Pond 2 Sandy Clay

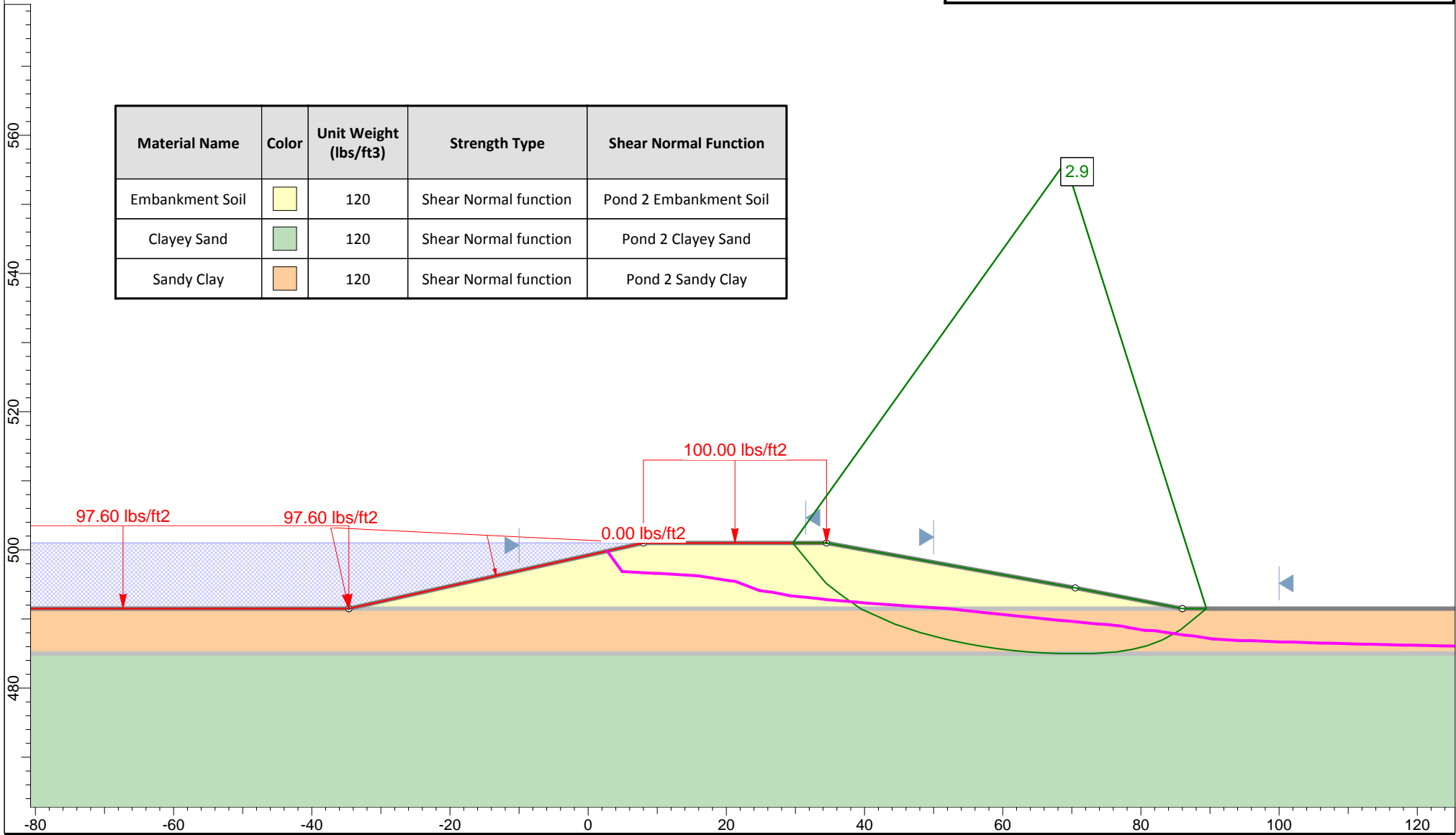

Profile "E" - Maximum Pool
Ash Pond Berms - Spruce/Deely Generation Units

Raba Kistner Consultants, Inc.
ASA12-098-00

Figure C-20a



Global Stability Analysis

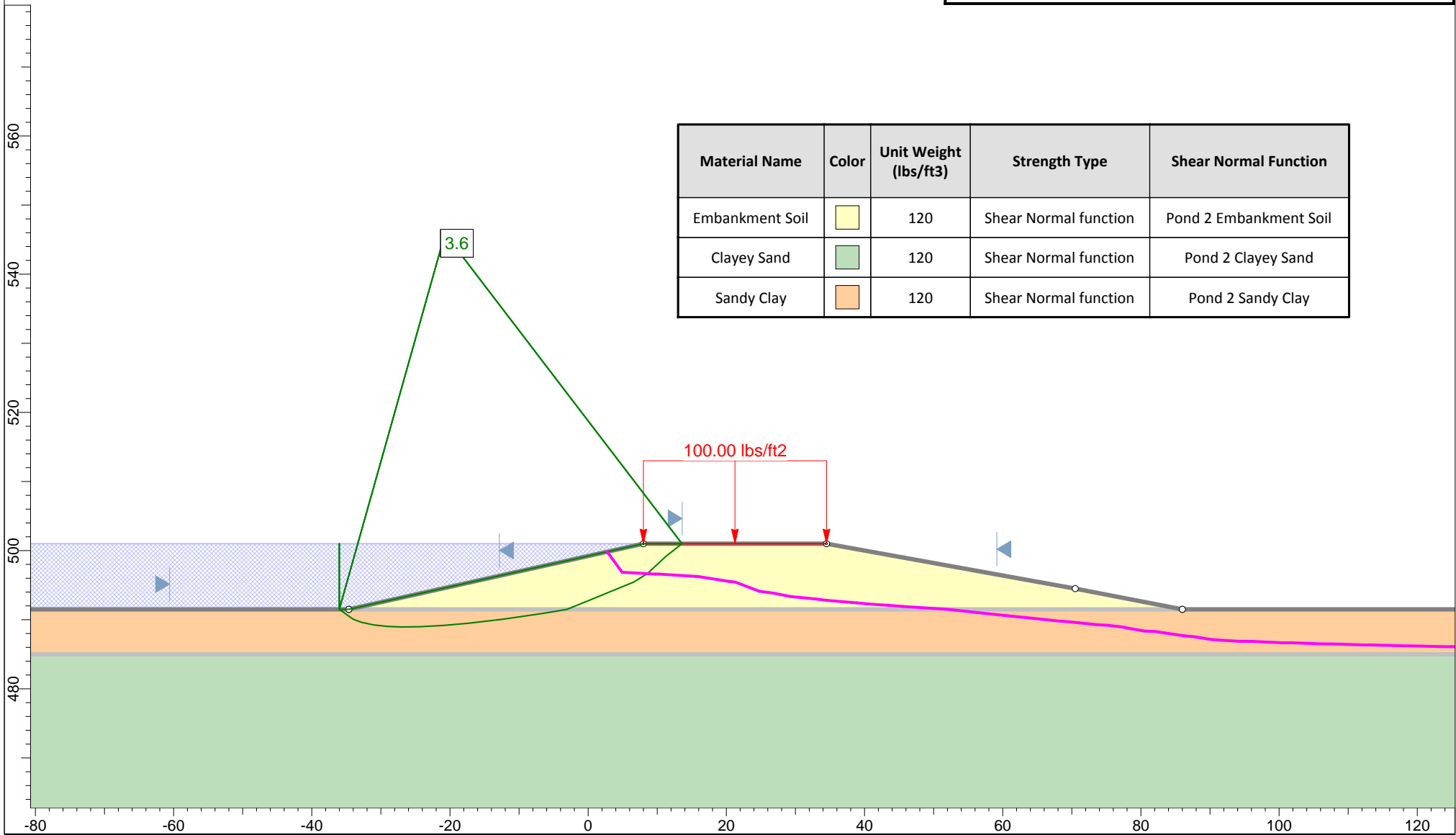

Material Name	Color	Unit Weight (lbs/ft ³)	Strength Type	Shear Normal Function
Embankment Soil		120	Shear Normal function	Pond 2 Embankment Soil
Clayey Sand		120	Shear Normal function	Pond 2 Clayey Sand
Sandy Clay		120	Shear Normal function	Pond 2 Sandy Clay

Profile "E" - Maximum Pool
Ash Pond Berms - Spruce/Deely Generation Units

Raba Kistner Consultants, Inc.
ASA12-098-00

Figure C-20b



Global Stability Analysis

Material Name	Color	Unit Weight (lbs/ft ³)	Strength Type	Shear Normal Function
Embankment Fill	Yellow	120	Shear Normal function	Pond 2 Embankment Soil
Clayey Sand	Green	120	Shear Normal function	Pond 2 Clayey Sand
Sandy Clay	Orange	120	Shear Normal function	Pond 2 Sandy Clay

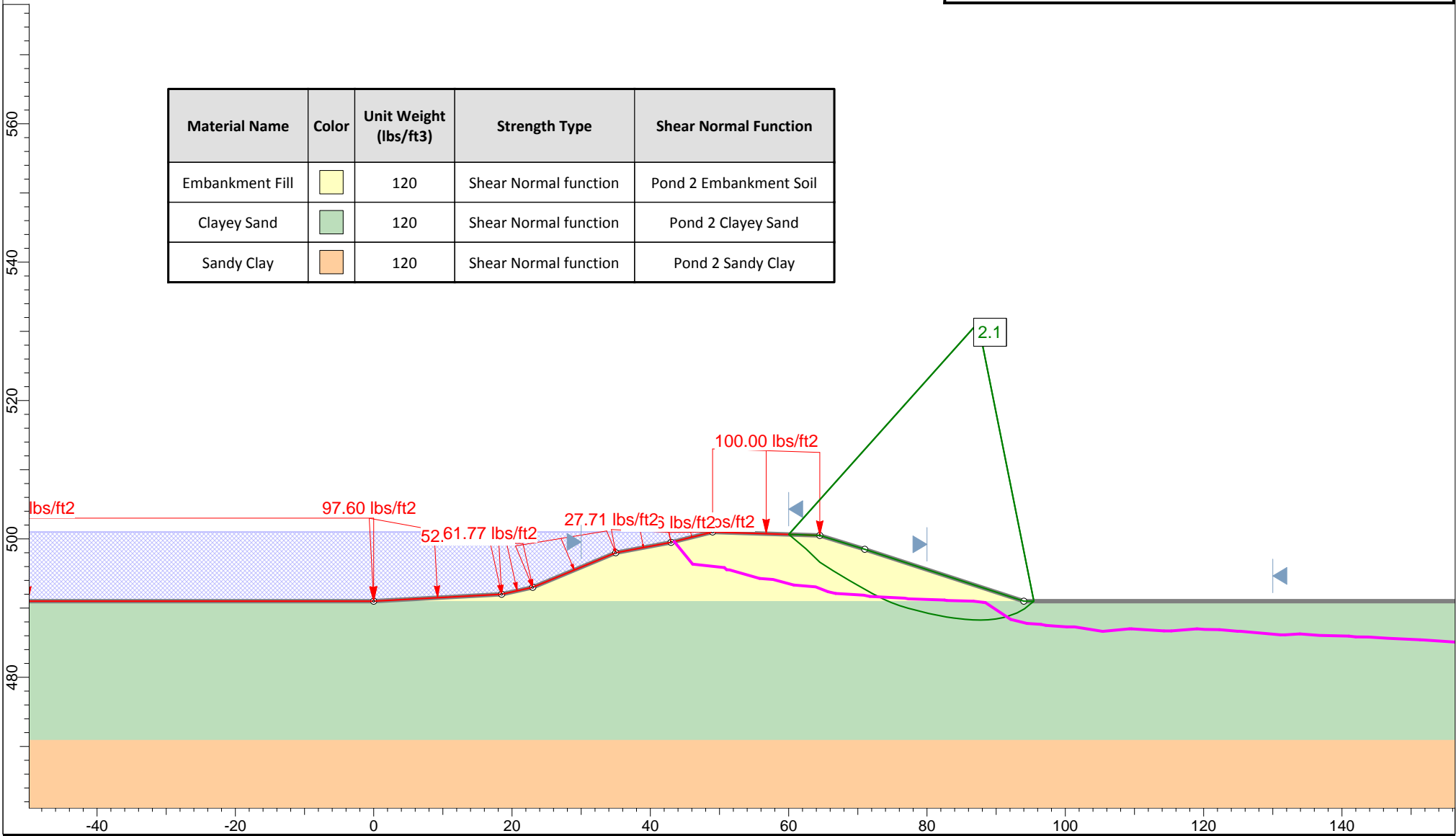



Profile "F" - Maximum Pool
Ash Pond Berms - Spruce/Deely Generation Units

Raba Kistner Consultants, Inc.
ASA12-098-00

Figure C-21a



Global Stability Analysis

Material Name	Color	Unit Weight (lbs/ft ³)	Strength Type	Shear Normal Function
Embankment Fill		120	Shear Normal function	Pond 2 Embankment Soil
Clayey Sand		120	Shear Normal function	Pond 2 Clayey Sand
Sandy Clay		120	Shear Normal function	Pond 2 Sandy Clay

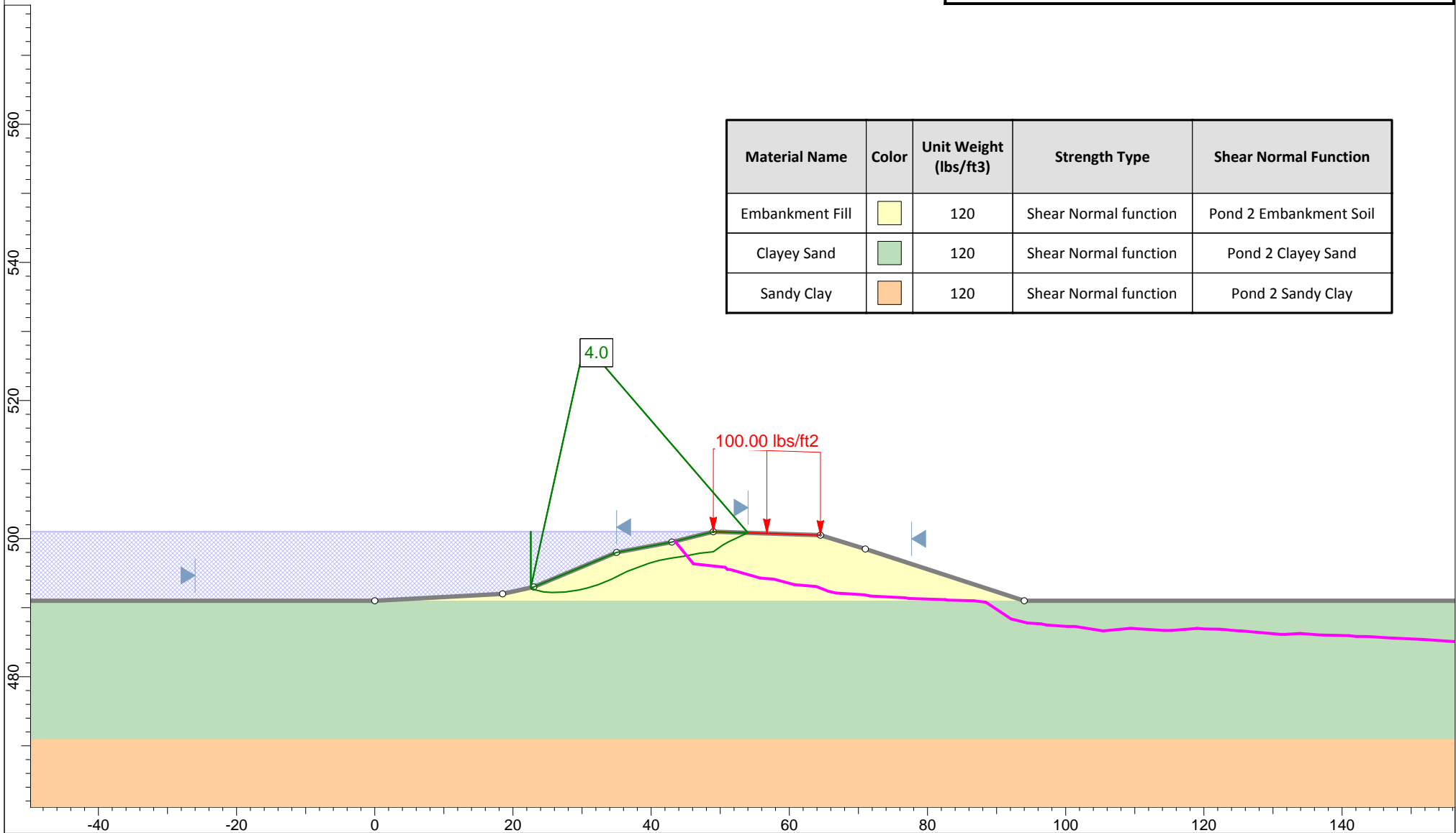



Profile "F" - Maximum Pool
Ash Pond Berms - Spruce/Deely Generation Units

Raba Kistner Consultants, Inc.
ASA12-098-00

Figure C-21b



Global Stability Analysis

Material Name	Color	Unit Weight (lbs/ft ³)	Strength Type	Shear Normal Function
Embankment Fill		120	Shear Normal function	Pond 2 Embankment Soil
Clayey Sand		120	Shear Normal function	Pond 2 Clayey Sand
Sandy Clay		120	Shear Normal function	Pond 2 Sandy Clay

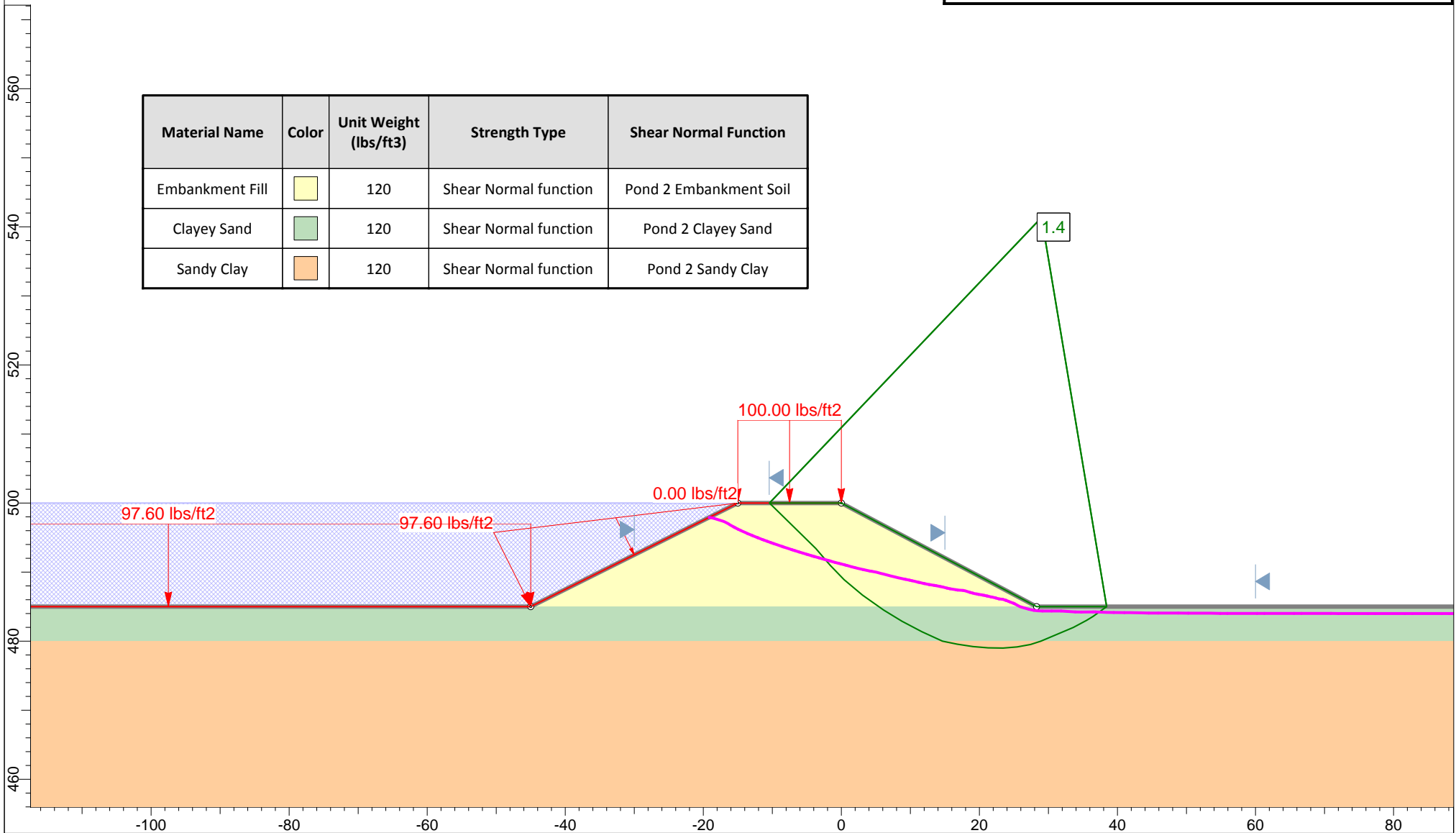



Profile "G" - Maximum Pool
Ash Pond Berms - Spruce/Deely Generation Units

Raba Kistner Consultants, Inc.
ASA12-098-00

Figure C-22a



Global Stability Analysis

Material Name	Color	Unit Weight (lbs/ft ³)	Strength Type	Shear Normal Function
Embankment Fill		120	Shear Normal function	Pond 2 Embankment Soil
Clayey Sand		120	Shear Normal function	Pond 2 Clayey Sand
Sandy Clay		120	Shear Normal function	Pond 2 Sandy Clay

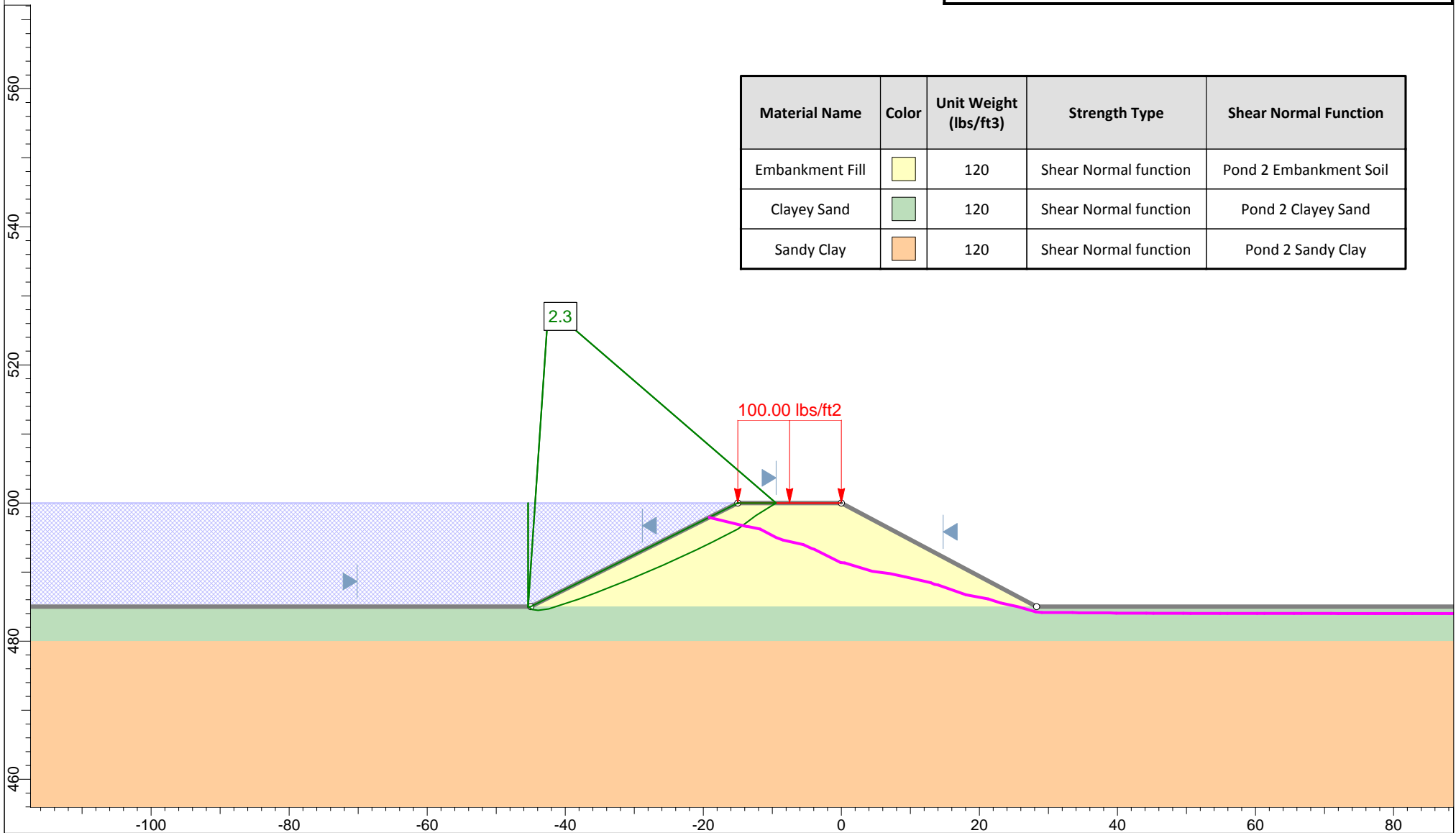



Profile "G" - Maximum Pool
Ash Pond Berms - Spruce/Deely Generation Units

Raba Kistner Consultants, Inc.
ASA12-098-00

Figure C-22b



Global Stability Analysis

Material Name	Color	Unit Weight (lbs/ft ³)	Strength Type	Shear Normal Function
Embankment Fill		120	Shear Normal function	Pond 2 Embankment Soil
Clayey Sand		120	Shear Normal function	Pond 2 Clayey Sand
Sandy Clay		120	Shear Normal function	Pond 2 Sandy Clay

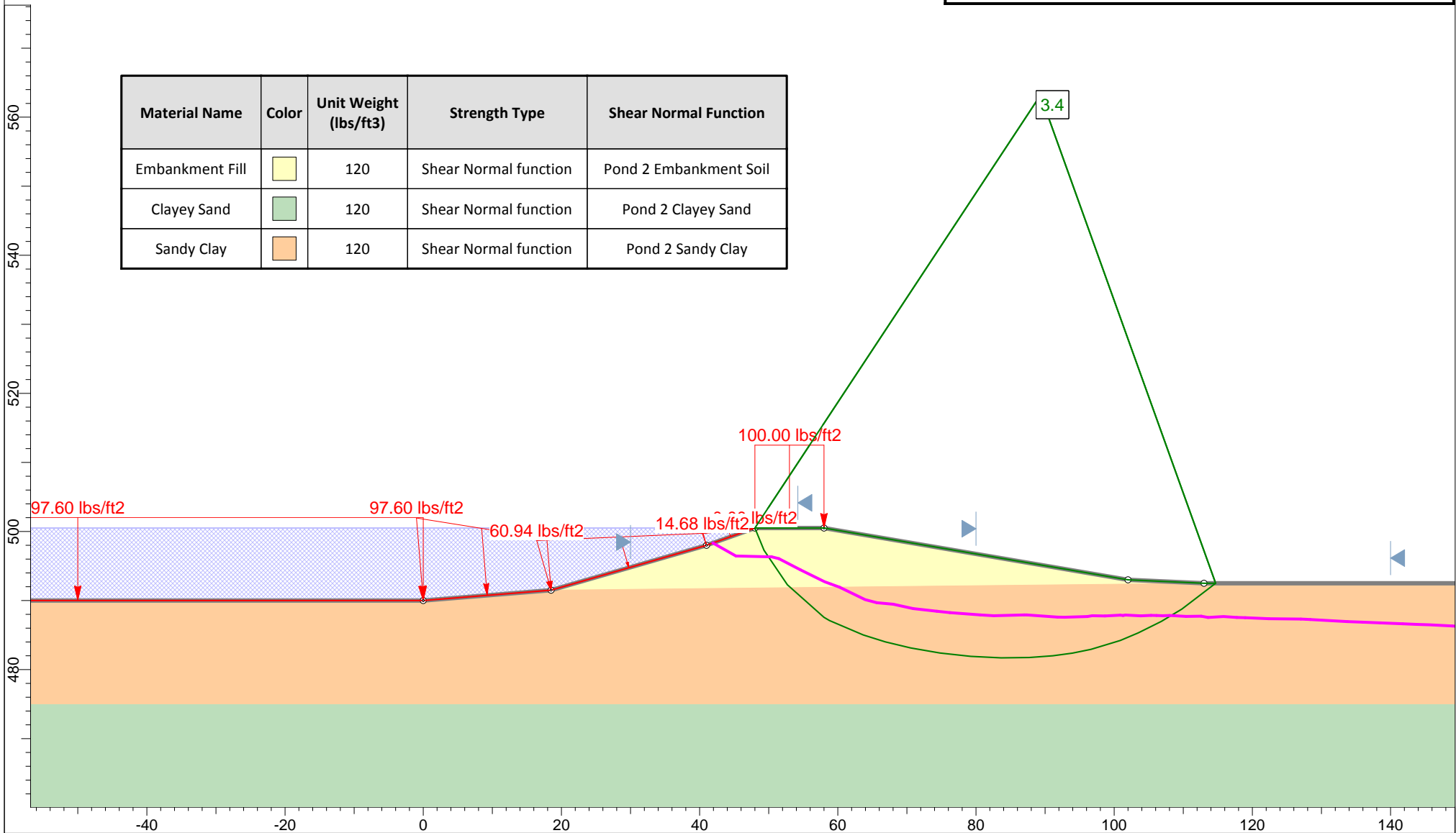



Profile "H" - Maximum Pool
Ash Pond Berms - Spruce/Deely Generation Units

Raba Kistner Consultants, Inc.
ASA12-098-00

Figure C-23a



Global Stability Analysis

Material Name	Color	Unit Weight (lbs/ft ³)	Strength Type	Shear Normal Function
Embankment Fill		120	Shear Normal function	Pond 2 Embankment Soil
Clayey Sand		120	Shear Normal function	Pond 2 Clayey Sand
Sandy Clay		120	Shear Normal function	Pond 2 Sandy Clay

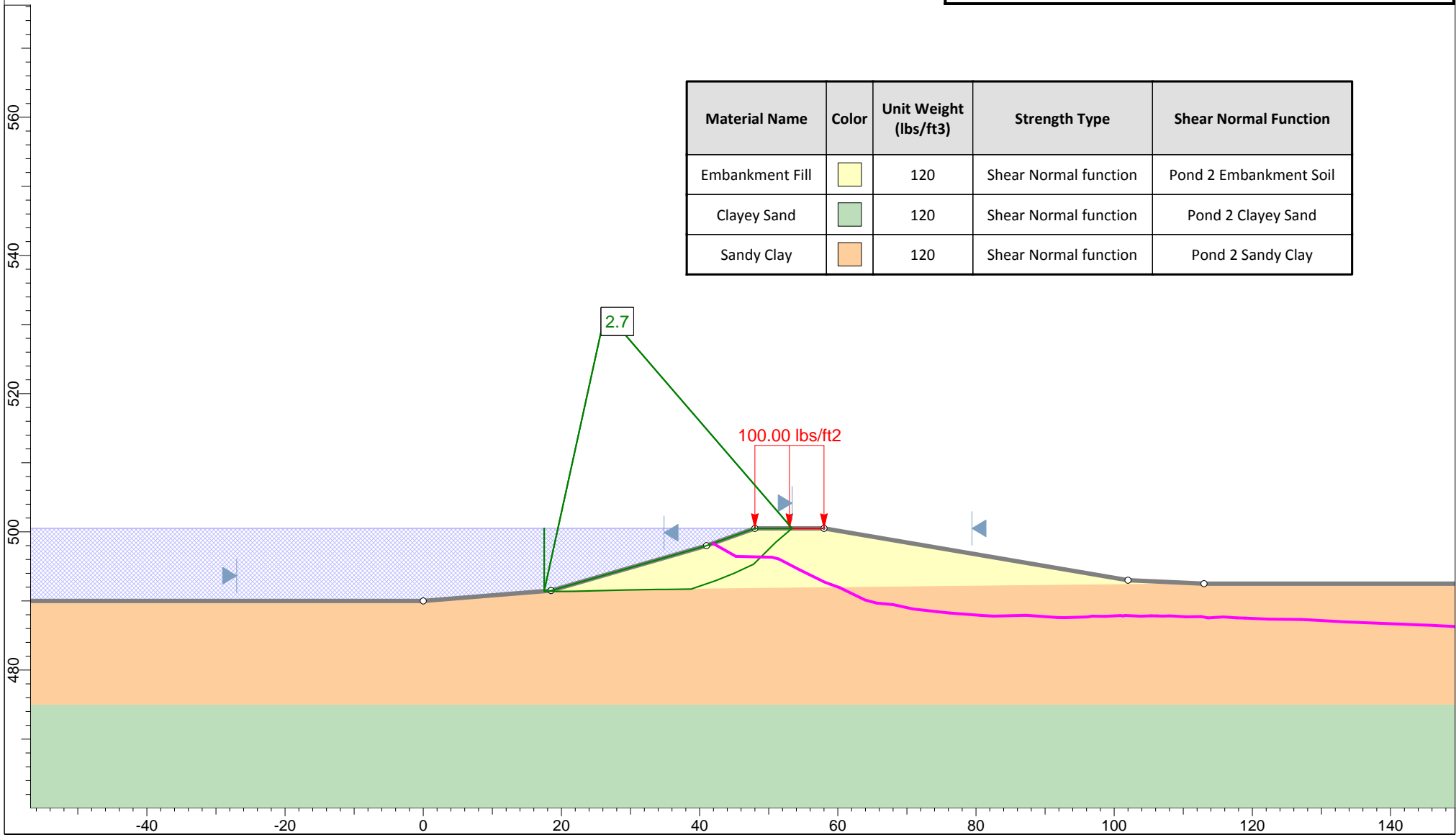



Profile "H" - Maximum Pool
Ash Pond Berms - Spruce/Deely Generation Units

Raba Kistner Consultants, Inc.
ASA12-098-00

Figure C-23b



Global Stability Analysis

Material Name	Color	Unit Weight (lbs/ft ³)	Strength Type	Shear Normal Function
Embankment Fill		120	Shear Normal function	Pond 2 Embankment Soil
Clayey Sand		120	Shear Normal function	Pond 2 Clayey Sand
Sandy Clay		120	Shear Normal function	Pond 2 Sandy Clay

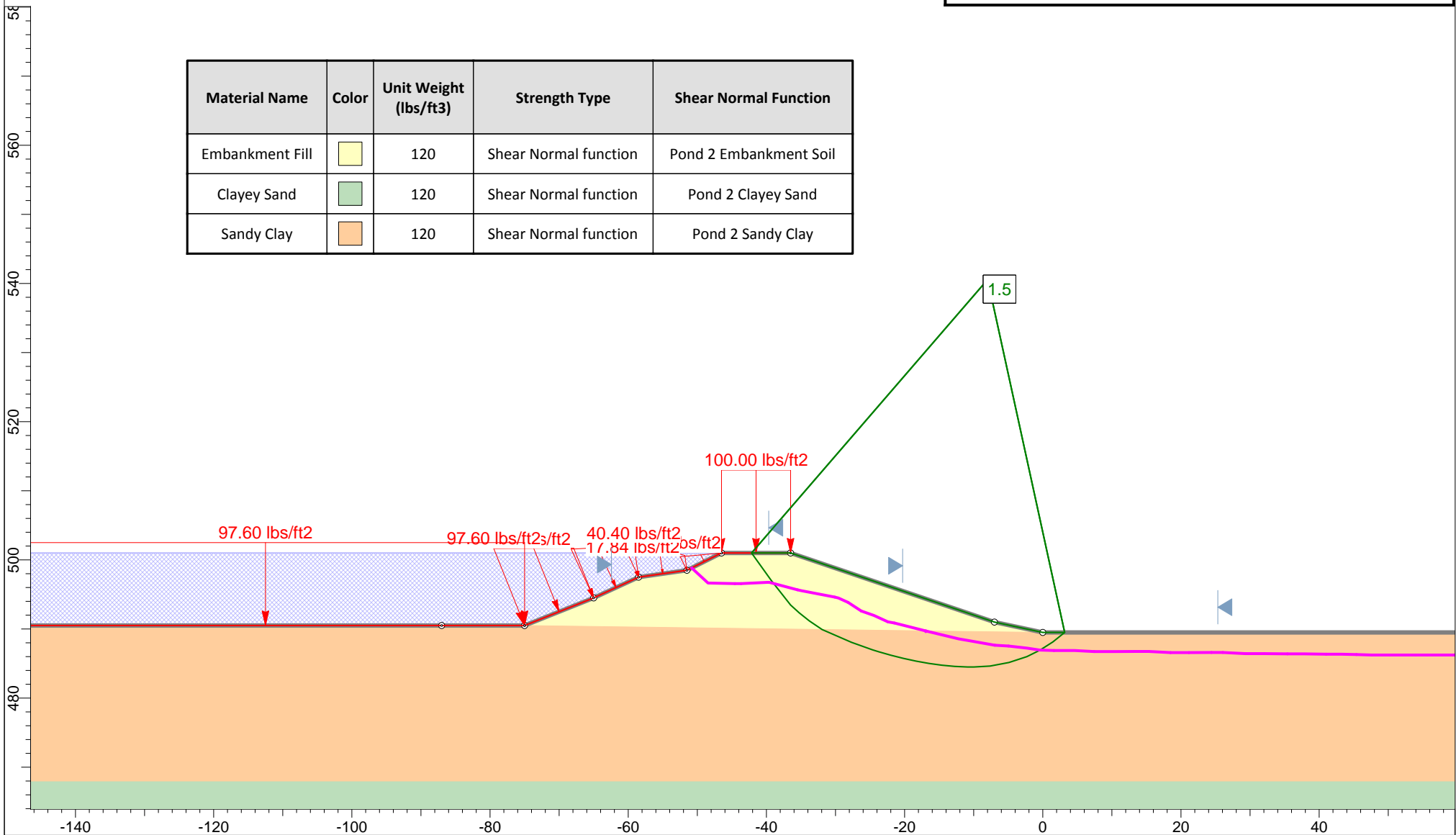



Profile "I" - Maximum Pool
Ash Pond Berms - Spruce/Deely Generation Units

Raba Kistner Consultants, Inc.
ASA12-098-00

Figure C-24a



Global Stability Analysis

Material Name	Color	Unit Weight (lbs/ft ³)	Strength Type	Shear Normal Function
Embankment Fill		120	Shear Normal function	Pond 2 Embankment Soil
Clayey Sand		120	Shear Normal function	Pond 2 Clayey Sand
Sandy Clay		120	Shear Normal function	Pond 2 Sandy Clay

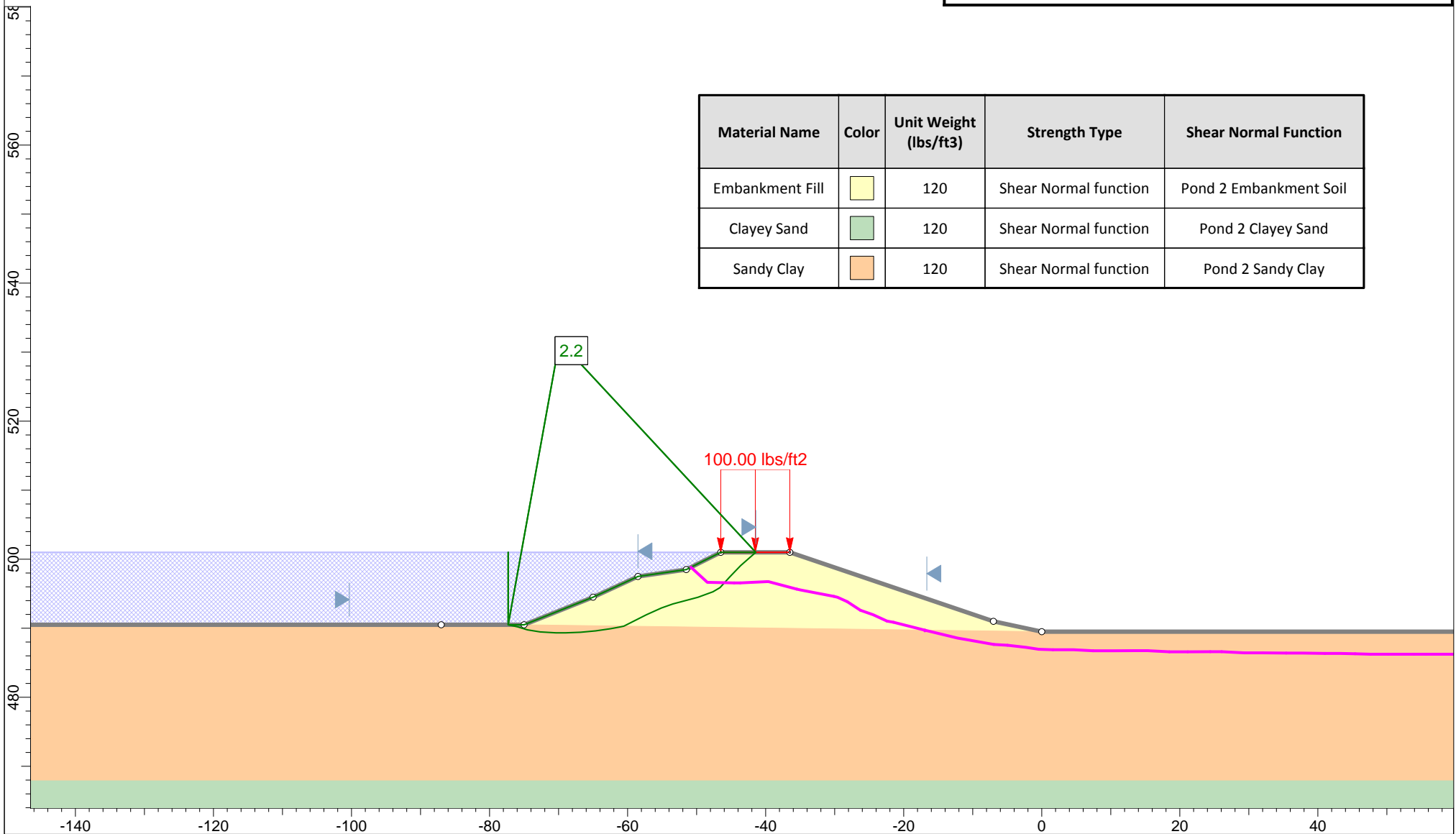



Profile "I" - Maximum Pool
Ash Pond Berms - Spruce/Deely Generation Units

Raba Kistner Consultants, Inc.
ASA12-098-00

Figure C-24b



Global Stability Analysis

Material Name	Color	Unit Weight (lbs/ft ³)	Strength Type	Shear Normal Function
Embankment Fill		120	Shear Normal function	Pond 1 Embankment Soil
Clayey Sand		120	Shear Normal function	Pond 1 Clayey Sand

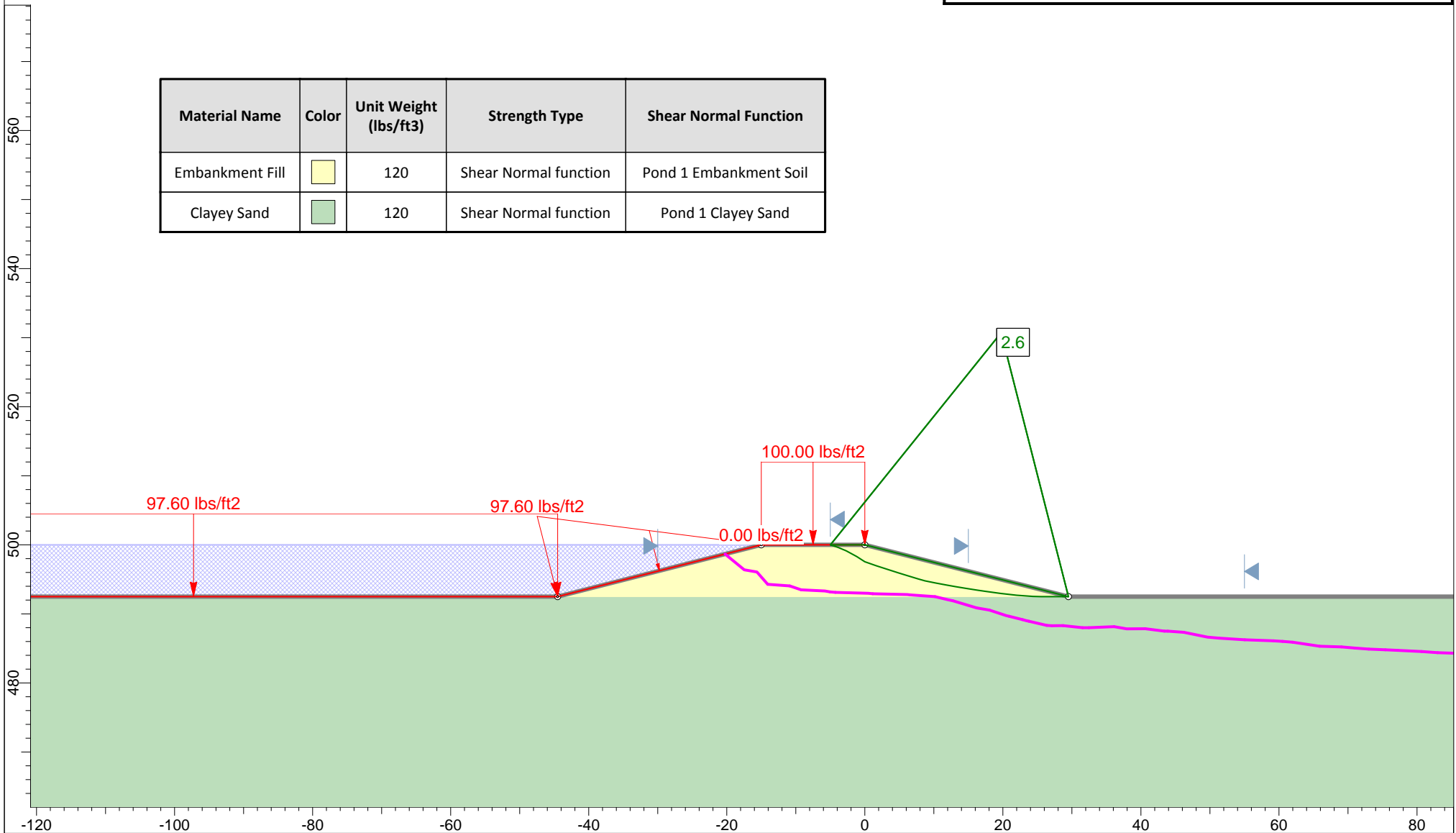



Profile "J" - Maximum Pool
Ash Pond Berms - Spruce/Deely Generation Units

Raba Kistner Consultants, Inc.
ASA12-098-00

Figure C-25a



Global Stability Analysis

Material Name	Color	Unit Weight (lbs/ft ³)	Strength Type	Shear Normal Function
Embankment Fill		120	Shear Normal function	Pond 1 Embankment Soil
Clayey Sand		120	Shear Normal function	Pond 1 Clayey Sand

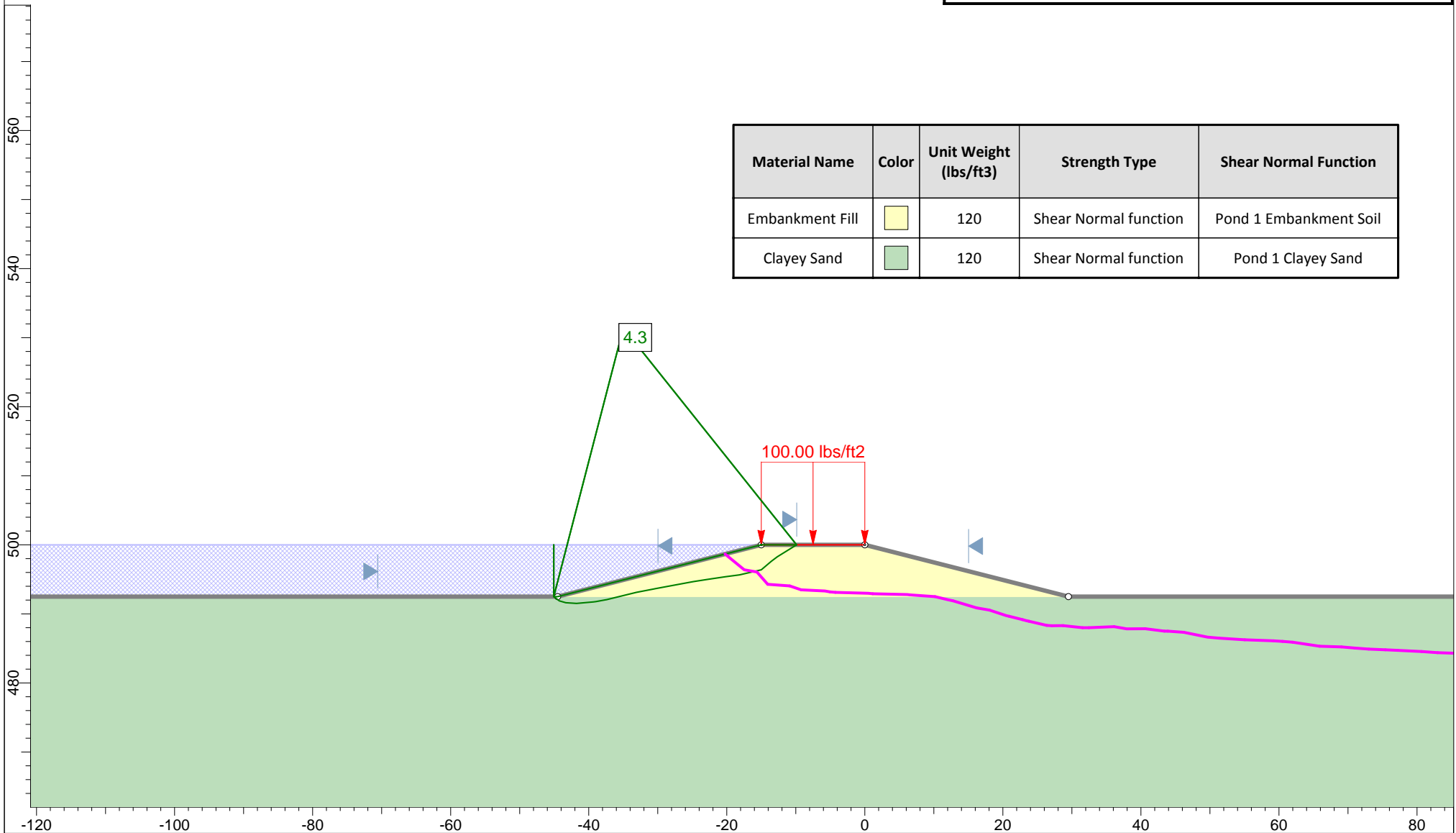



Profile "J" - Maximum Pool
Ash Pond Berms - Spruce/Deely Generation Units

Raba Kistner Consultants, Inc.
ASA12-098-00

Figure C-25b



Global Stability Analysis

Material Name	Color	Unit Weight (lbs/ft ³)	Strength Type	Shear Normal Function
Embankment Fill		120	Shear Normal function	Pond 1 Embankment Soil
Sandy Clay		120	Shear Normal function	Pond 1 Sandy Clay

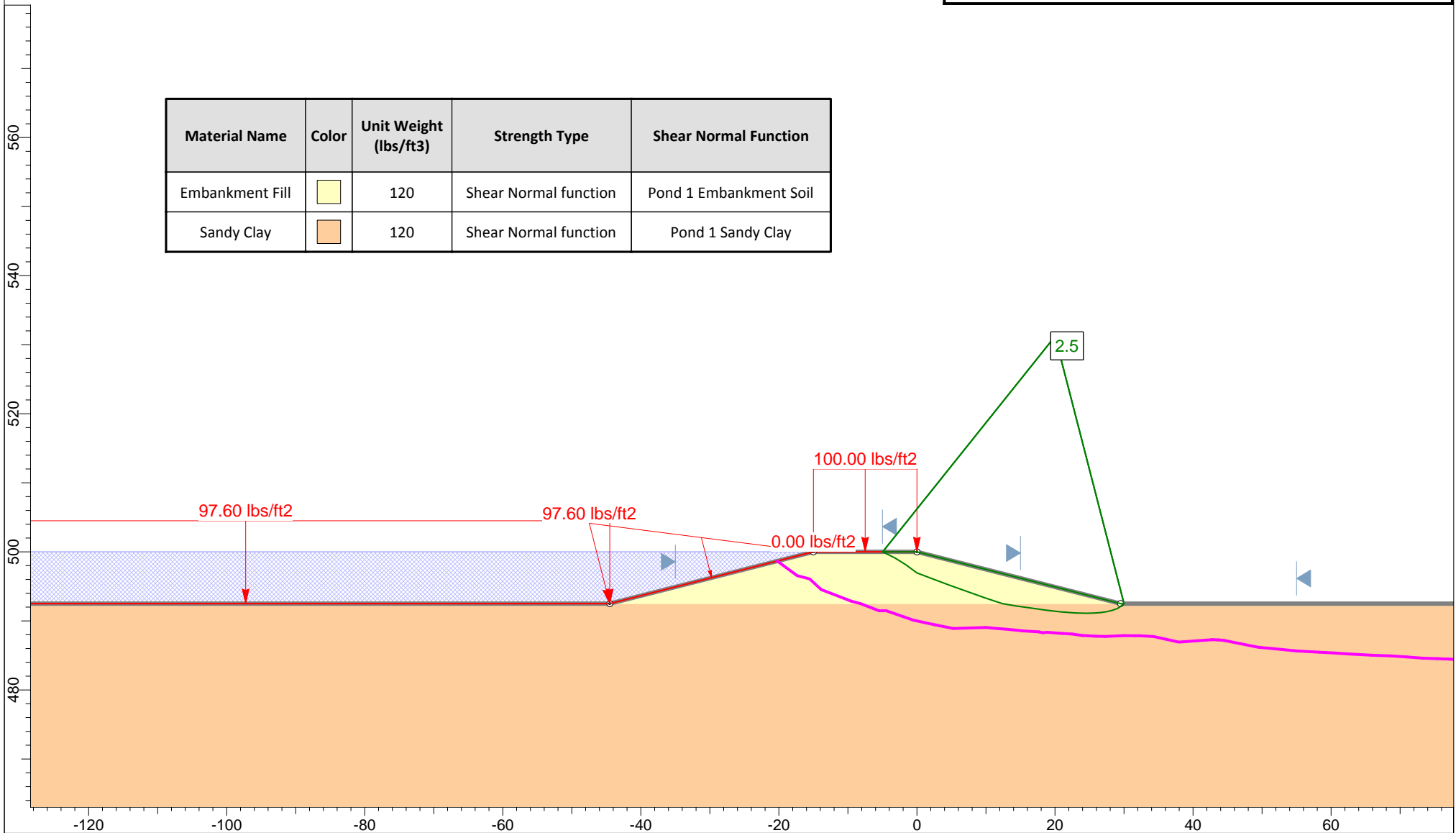



Profile "K" - Maximum Pool
Ash Pond Berms - Spruce/Deely Generation Units

Raba Kistner Consultants, Inc.
ASA12-098-00

Figure C-26a



Global Stability Analysis

Material Name	Color	Unit Weight (lbs/ft ³)	Strength Type	Shear Normal Function
Embankment Fill		120	Shear Normal function	Pond 1 Embankment Soil
Sandy Clay		120	Shear Normal function	Pond 1 Sandy Clay

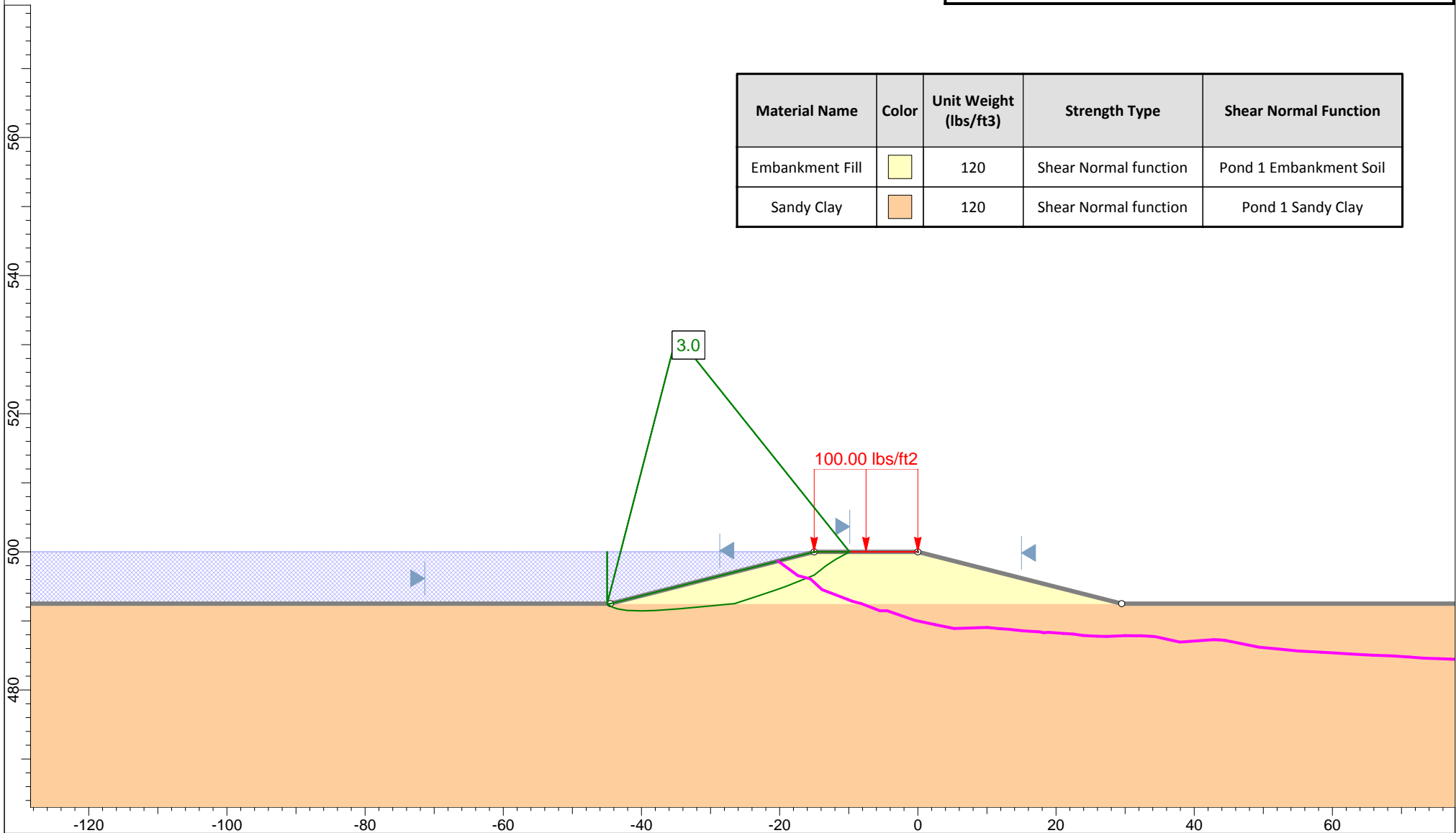



Profile "K" - Maximum Pool
Ash Pond Berms - Spruce/Deely Generation Units

Raba Kistner Consultants, Inc.
ASA12-098-00

Figure C-26b



Global Stability Analysis

Material Name	Color	Unit Weight (lbs/ft ³)	Strength Type	Shear Normal Function
Embankment Fill		120	Shear Normal function	Pond 1 Embankment Soil
Clayey Sand		120	Shear Normal function	Pond 1 Clayey Sand
Sandy Clay		120	Shear Normal function	Pond 1 Sandy Clay

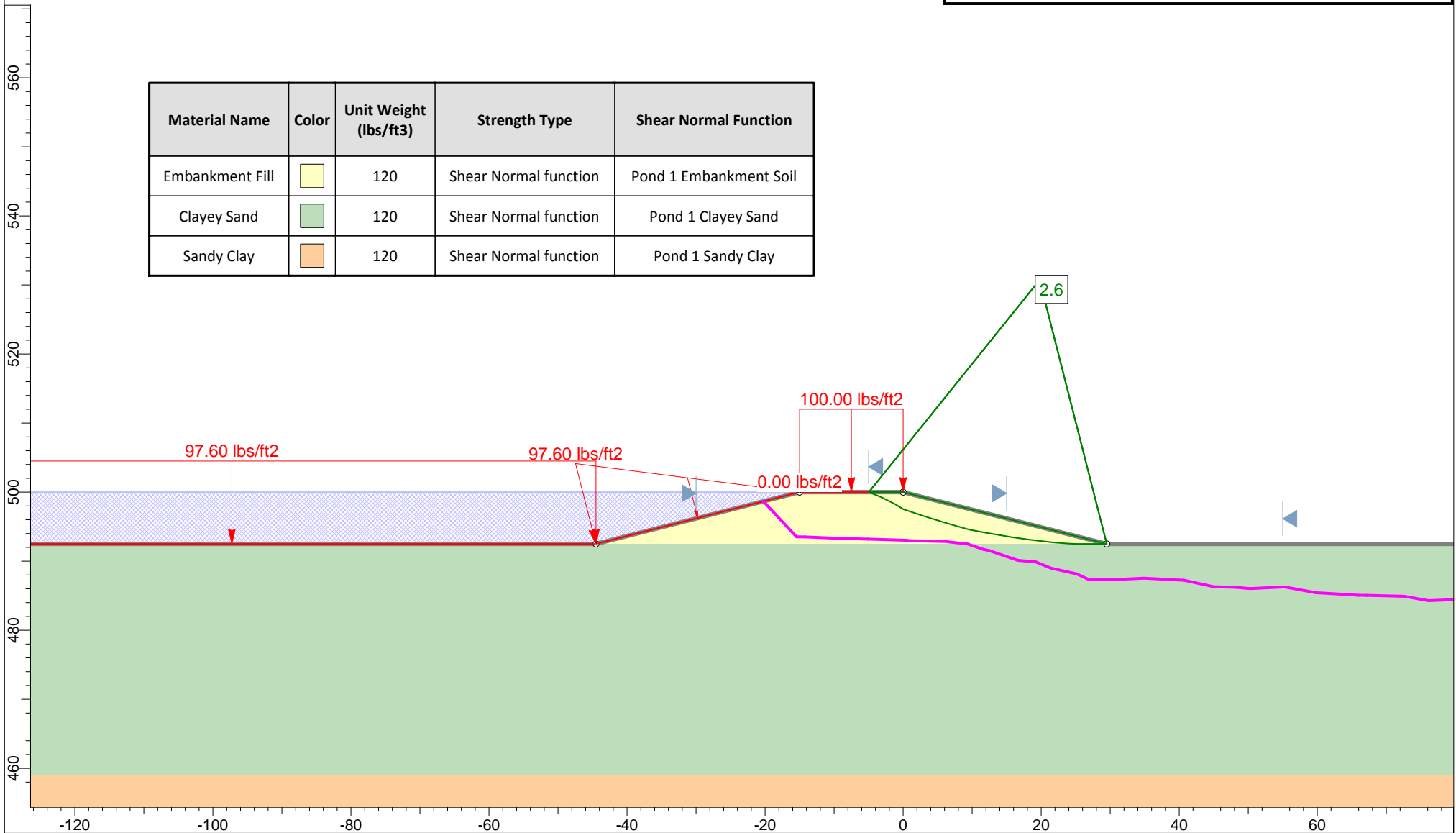



Profile "L" - Maximum Pool
Ash Pond Berms - Spruce/Deely Generation Units

Raba Kistner Consultants, Inc.
ASA12-098-00

Figure C-27a



Global Stability Analysis

Material Name	Color	Unit Weight (lbs/ft ³)	Strength Type	Shear Normal Function
Embankment Fill		120	Shear Normal function	Pond 1 Embankment Soil
Clayey Sand		120	Shear Normal function	Pond 1 Clayey Sand
Sandy Clay		120	Shear Normal function	Pond 1 Sandy Clay

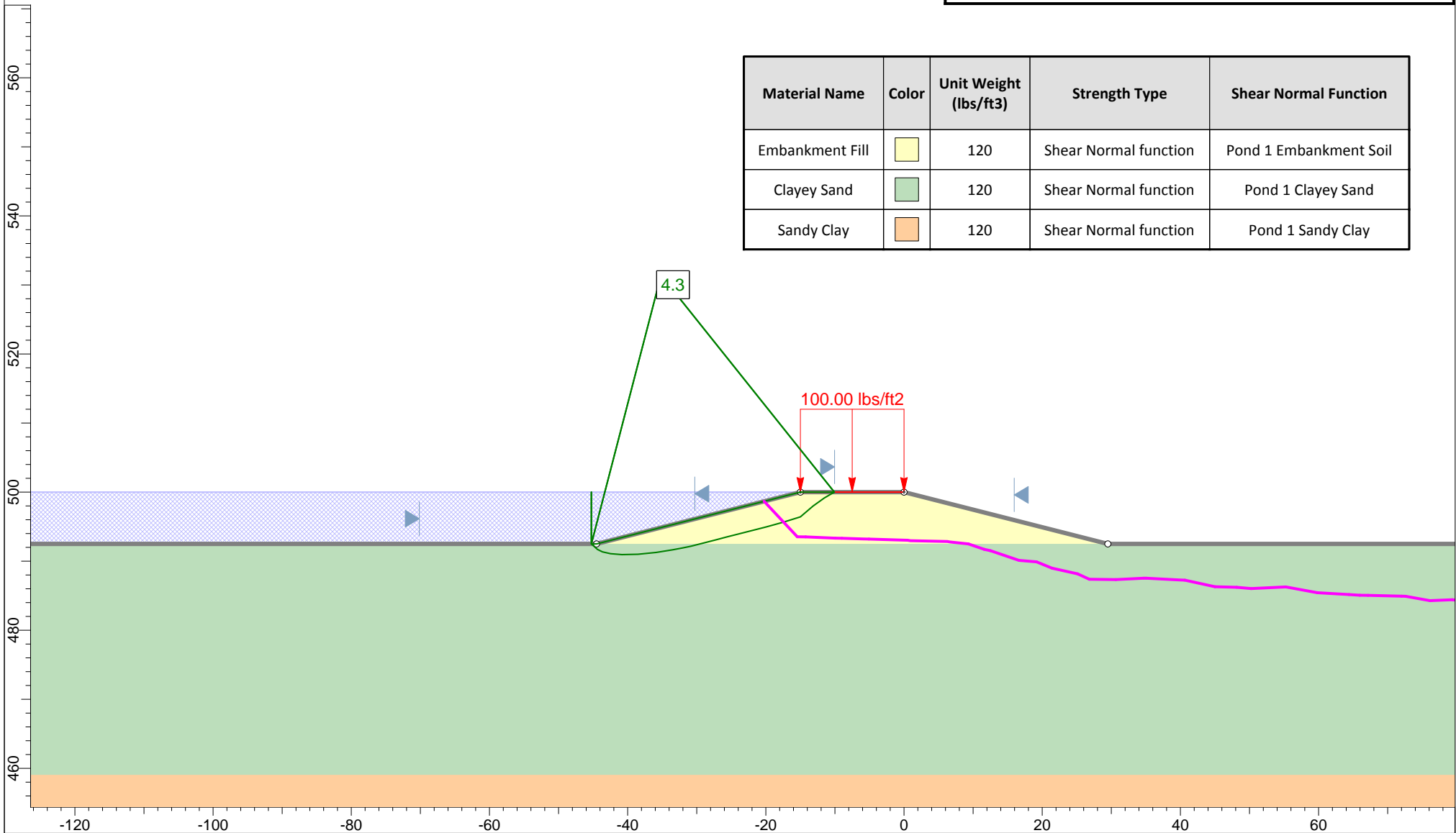



Profile "L" - Maximum Pool
Ash Pond Berms - Spruce/Deely Generation Units

Raba Kistner Consultants, Inc.
ASA12-098-00

Figure C-27b



Global Stability Analysis

Material Name	Color	Unit Weight (lbs/ft ³)	Strength Type	Shear Normal Function
Embankment Fill		120	Shear Normal function	Pond 1 Embankment Soil
Clayey Sand		120	Shear Normal function	Pond 1 Clayey Sand
Sandy Clay		120	Shear Normal function	Pond 1 Sandy Clay

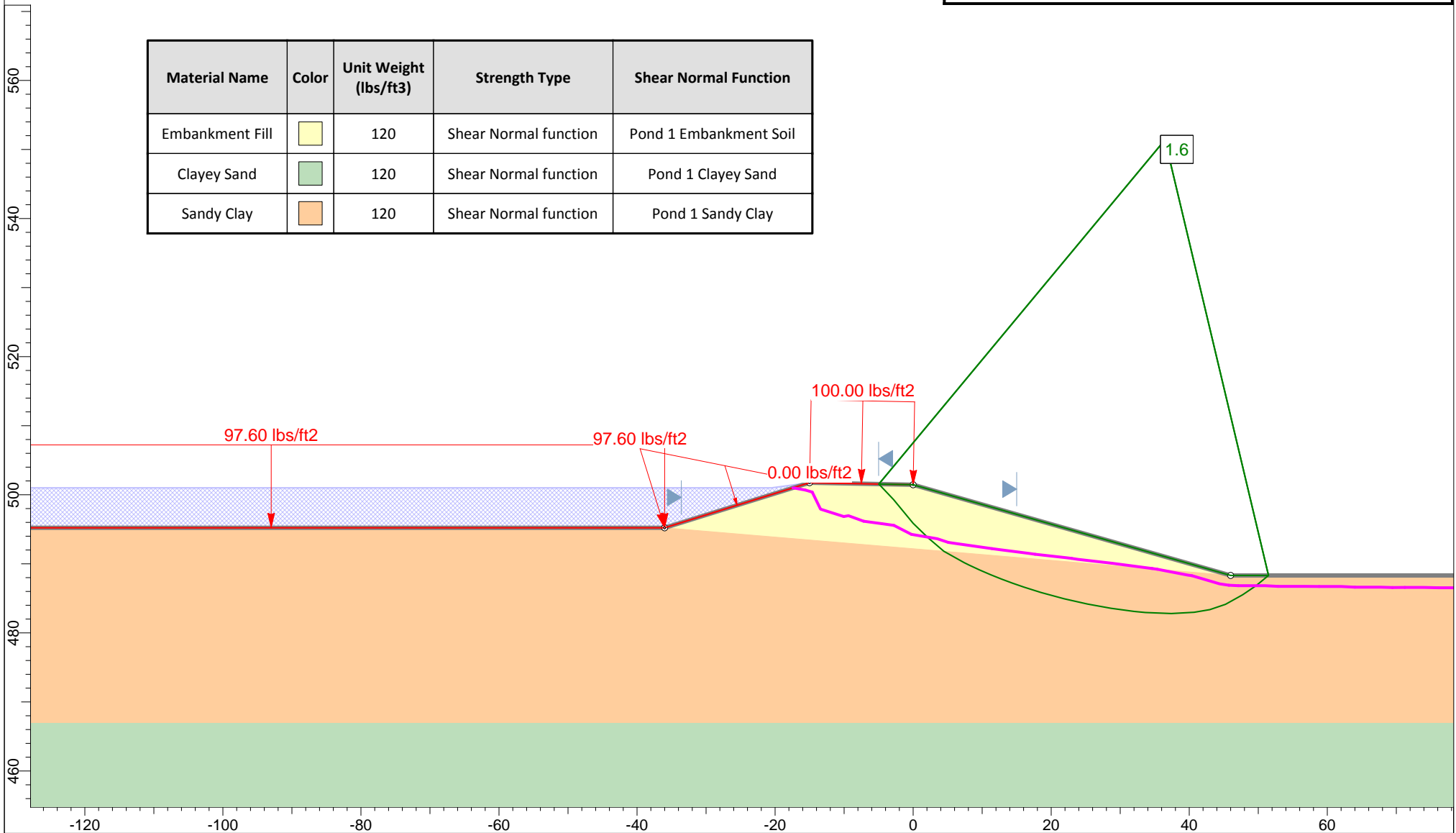

Profile "M" - Maximum Pool
Ash Pond Berms - Spruce/Deely Generation Units

Raba Kistner Consultants, Inc.
ASA12-098-00

Figure C-28a



Global Stability Analysis

Material Name	Color	Unit Weight (lbs/ft3)	Strength Type	Shear Normal Function
Embankment Fill	Yellow	120	Shear Normal function	Pond 1 Embankment Soil
Clayey Sand	Green	120	Shear Normal function	Pond 1 Clayey Sand
Sandy Clay	Orange	120	Shear Normal function	Pond 1 Sandy Clay

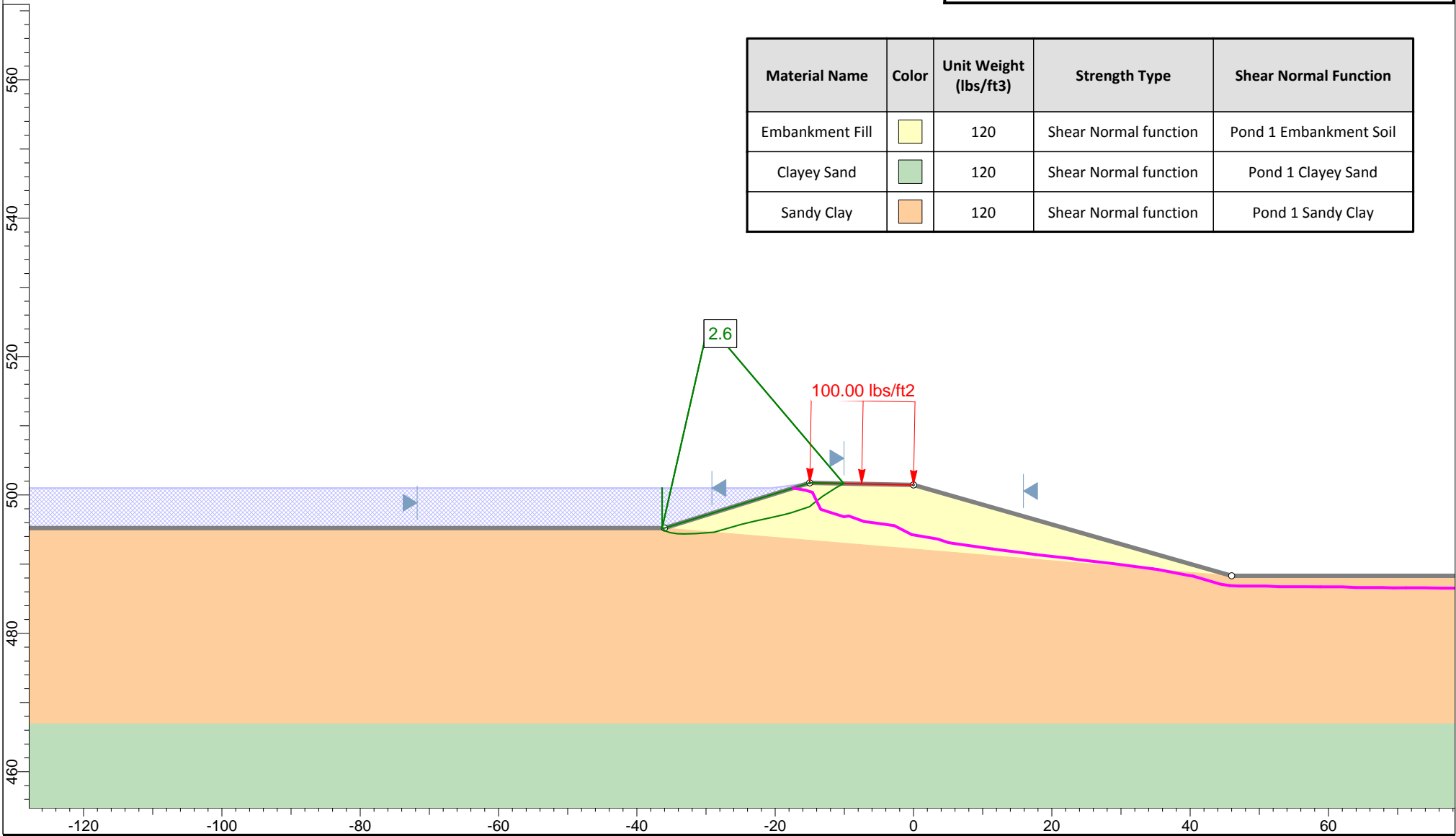

Profile "M" - Maximum Pool
Ash Pond Berms - Spruce/Deely Generation Units

Raba Kistner Consultants, Inc.
ASA12-098-00

Figure C-28b



Global Stability Analysis

Material Name	Color	Unit Weight (lbs/ft ³)	Strength Type	Shear Normal Function
Embankment Fill		120	Shear Normal function	Pond 2 Embankment Soil
Clayey Sand		120	Shear Normal function	Pond 2 Clayey Sand

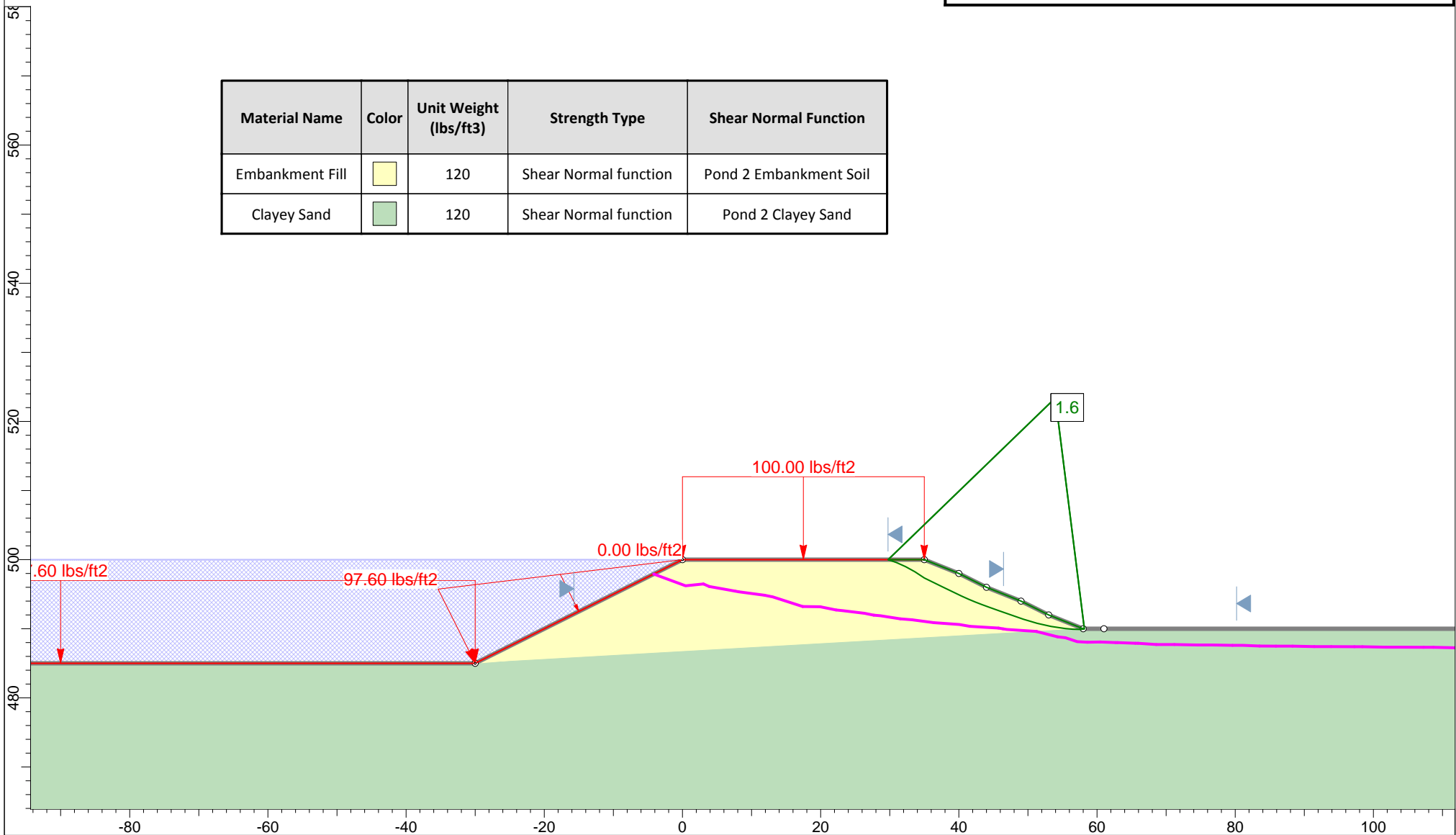



Profile "N" - Maximum Pool
Ash Pond Berms - Spruce/Deely Generation Units

Raba Kistner Consultants, Inc.
ASA12-098-00

Figure C-29a



Global Stability Analysis

Material Name	Color	Unit Weight (lbs/ft ³)	Strength Type	Shear Normal Function
Embankment Fill		120	Shear Normal function	Pond 2 Embankment Soil
Clayey Sand		120	Shear Normal function	Pond 2 Clayey Sand

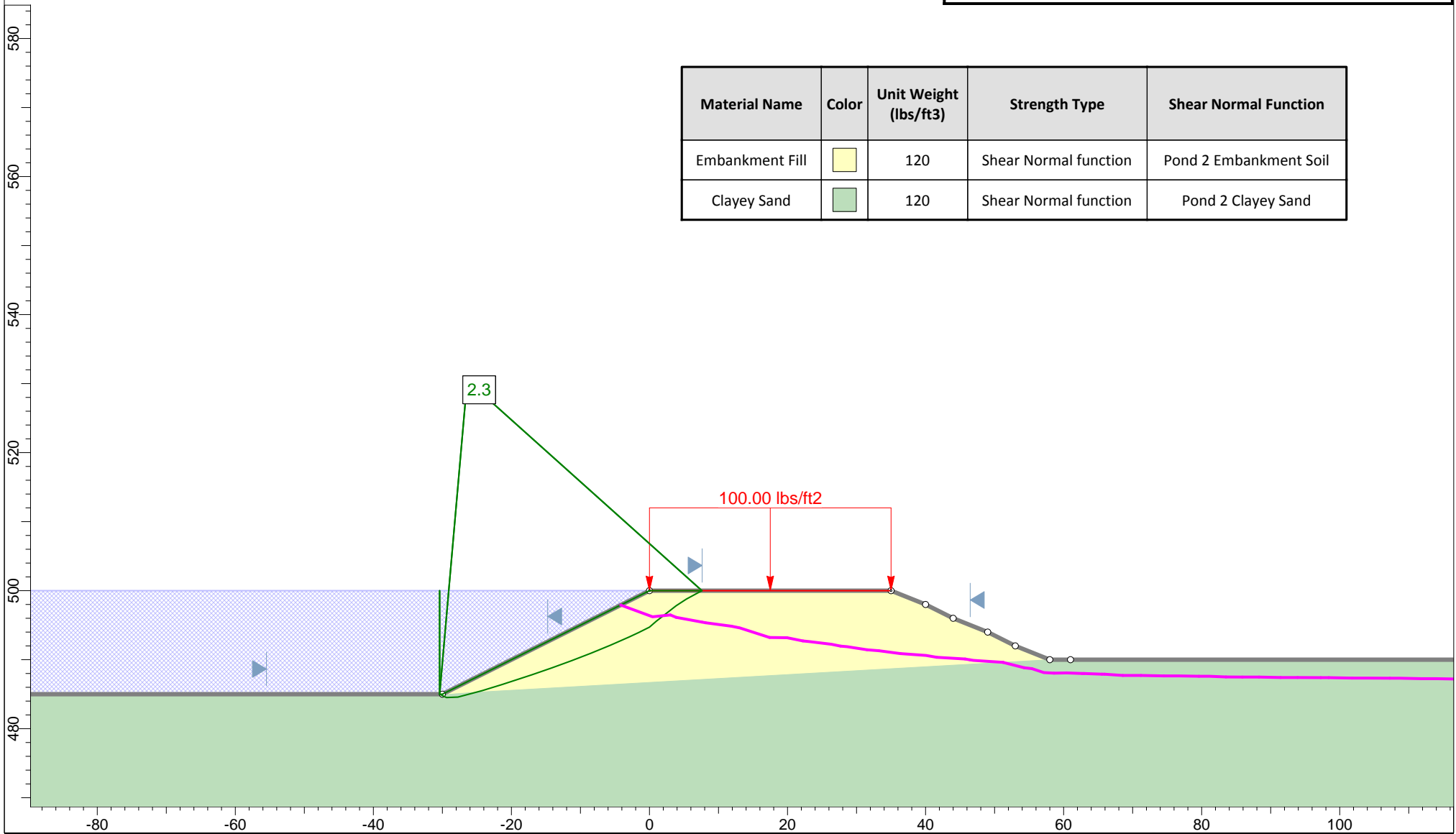

Profile "N" - Maximum Pool
Ash Pond Berms - Spruce/Deely Generation Units

Raba Kistner Consultants, Inc.
ASA12-098-00

Figure C-29b



APPENDIX D

SEISMIC ANALYSES

Design Maps Summary Report

User-Specified Input

Building Code Reference Document 2009 NEHRP Recommended Seismic Provisions
(which makes use of 2008 USGS hazard data)

Site Coordinates 29.30821°N, 98.3168°W

Site Soil Classification Site Class D - "Stiff Soil"

Risk Category I/II/III

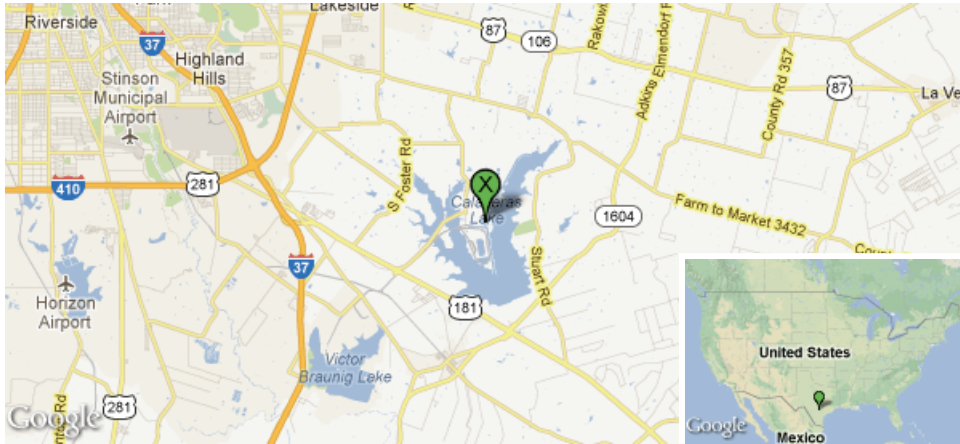

USGS-Provided Output

$S_s = 0.092 \text{ g}$	$S_{MS} = 0.147 \text{ g}$	$S_{DS} = 0.098 \text{ g}$
$S_1 = 0.031 \text{ g}$	$S_{M1} = 0.075 \text{ g}$	$S_{D1} = 0.050 \text{ g}$

For information on how the S_s and S_1 values above have been calculated from probabilistic (risk-targeted) and deterministic ground motions in the direction of maximum horizontal response, please [view the detailed report](#).

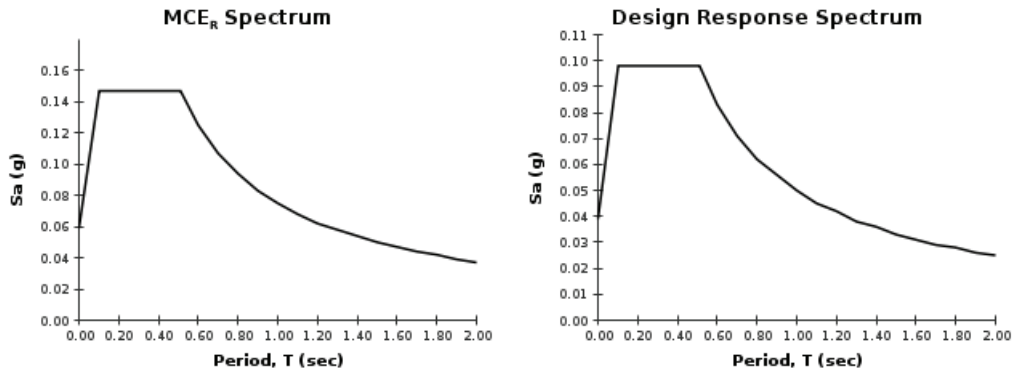

For PGA_M , T_L , C_{RSF} , and C_{R1} values, please [view the detailed report](#).

Although this information is a product of the U.S. Geological Survey, we provide no warranty, expressed or implied, as to the accuracy of the data contained therein. This tool is not a substitute for technical subject-matter knowledge.

Probability of earthquake with $M > 5.0$ within 250 years & 50 km

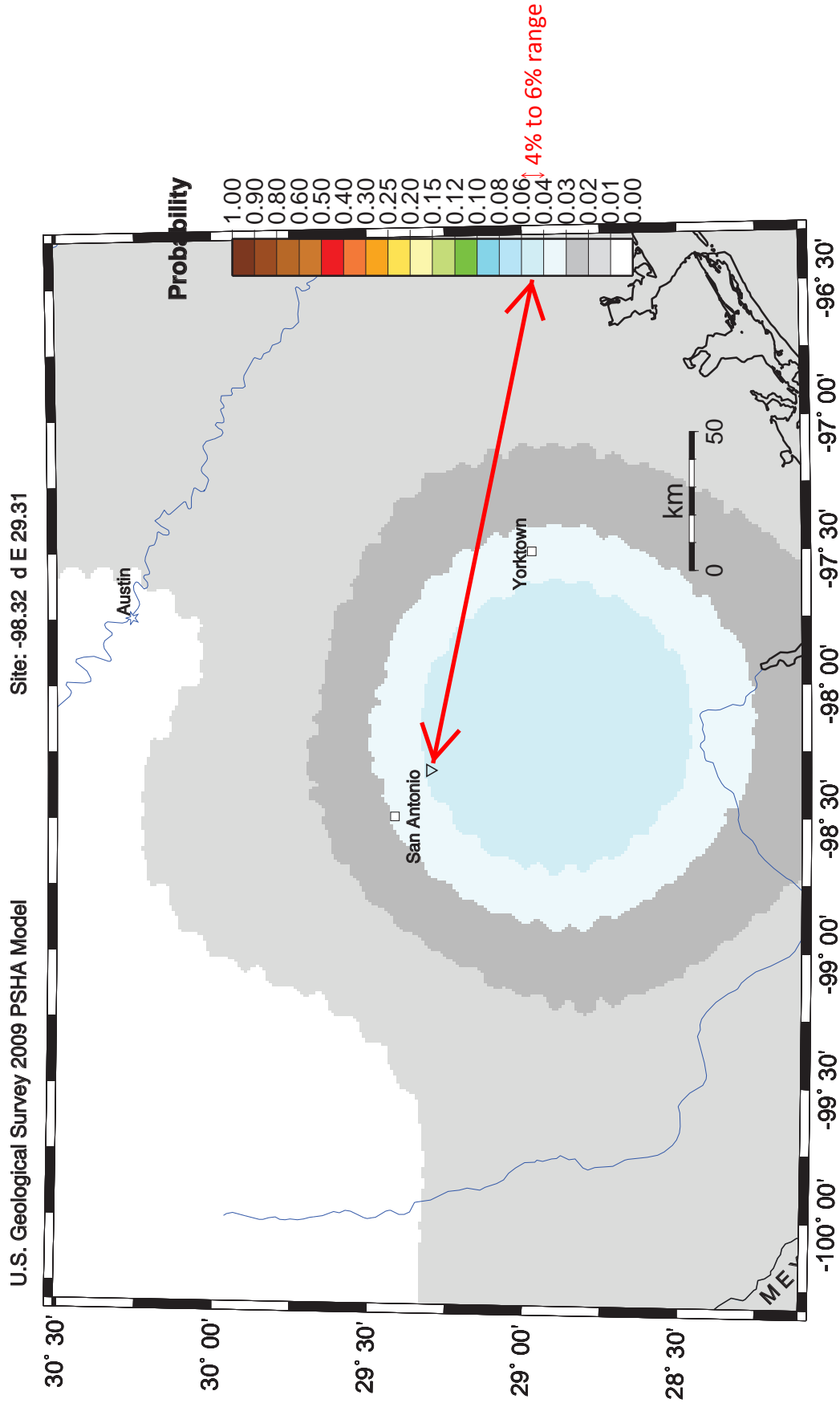

GMT 2012 Nov 19 15:18:38 Earthquake probabilities from USGS OFR 08-1128 PSHA. 50 km maximum horizontal distance. Site of interest: triangle. Epicenters mbs=5 black circles; rivers blue.

USGS Design Maps Detailed Report

2009 NEHRP Recommended Seismic Provisions (29.30821°N, 98.3168°W)

Section 11.4.1 — Mapped Acceleration Parameters and Risk Coefficients

Note: Ground motion values contoured on Figures 22-1, 2, 5, & 6 below are for the direction of maximum horizontal spectral response acceleration. They have been converted from corresponding geometric mean ground motions computed by the USGS by applying factors of 1.1 (to obtain S_{SUH} and S_{SD}) and 1.3 (to obtain S_{1UH} and S_{1D}). Maps in the 2009 NEHRP Provisions are provided for Site Class B. Adjustments for other Site Classes are made, as needed, in Section 11.4.3.

Figure 22-1: Uniform-Hazard (2% in 50-Year) Ground Motions of 0.2-Second Spectral Response Acceleration (5% of Critical Damping), Site Class B

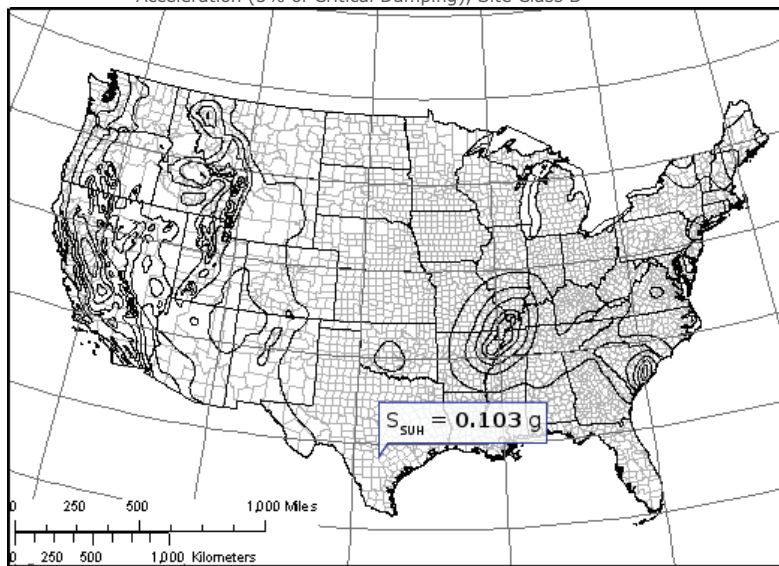

Figure 22-2: Uniform-Hazard (2% in 50-Year) Ground Motions of 1.0-Second Spectral Response Acceleration (5% of Critical Damping), Site Class B

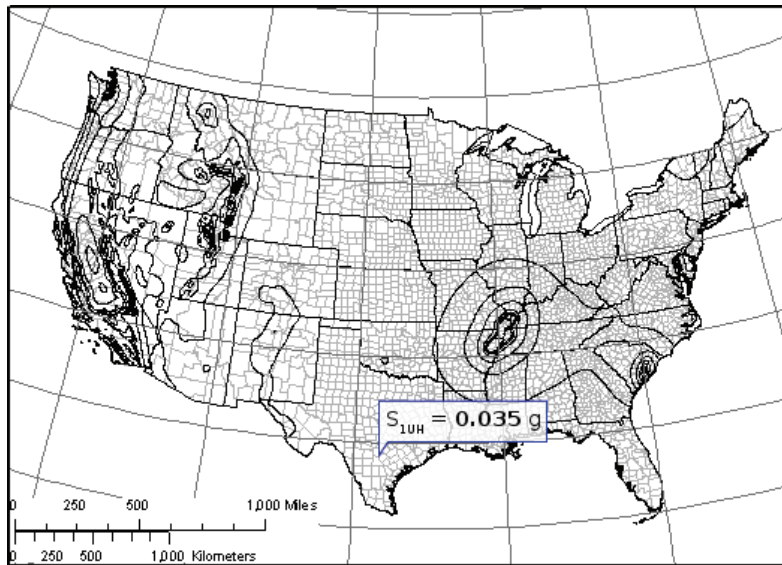

Figure 22-3: Risk Coefficient at 0.2-Second Spectral Response Period

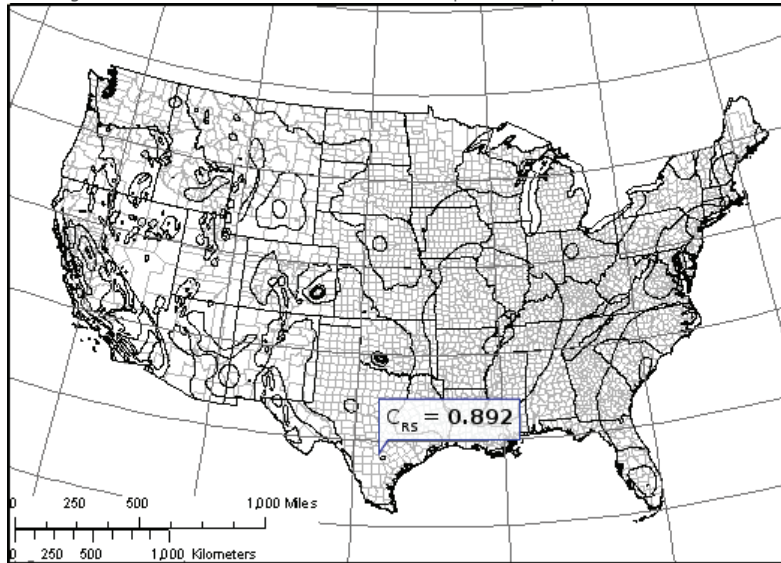

Figure 22-4: Risk Coefficient at 1.0-Second Spectral Response Period

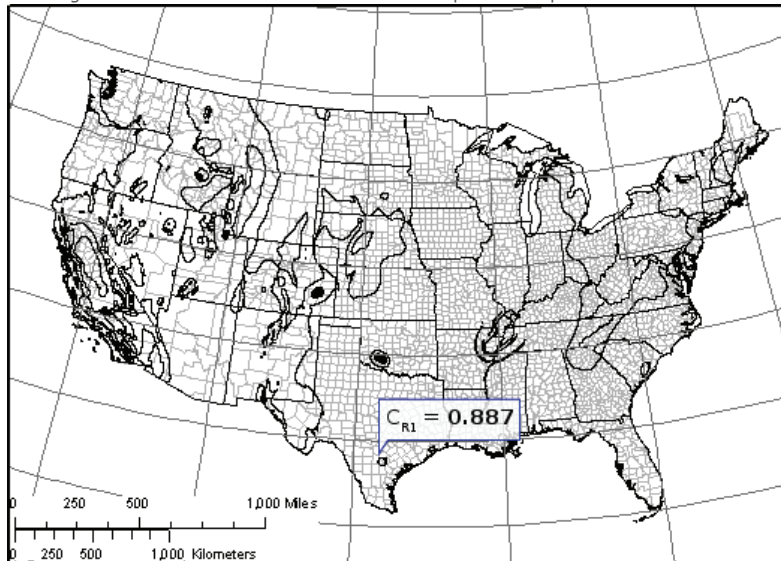

Figure 22-5: Deterministic Ground Motions of 0.2-Second Spectral Response Acceleration (5% of Critical Damping), Site Class B

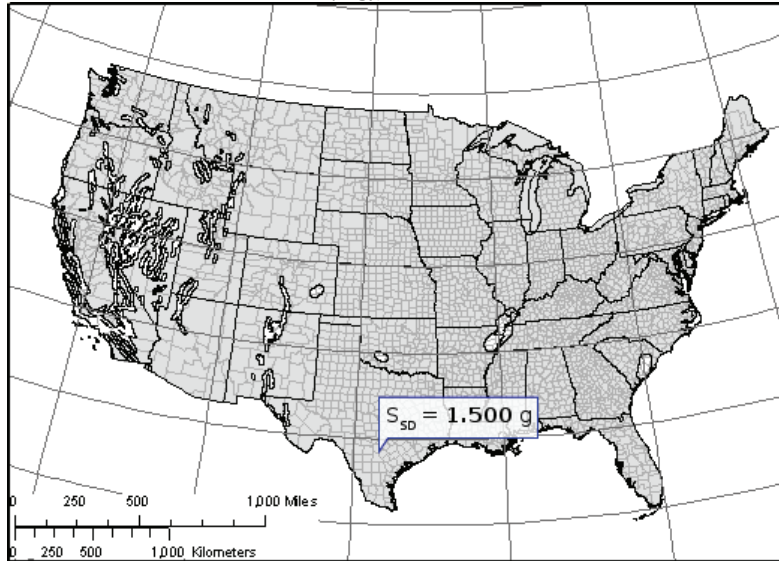
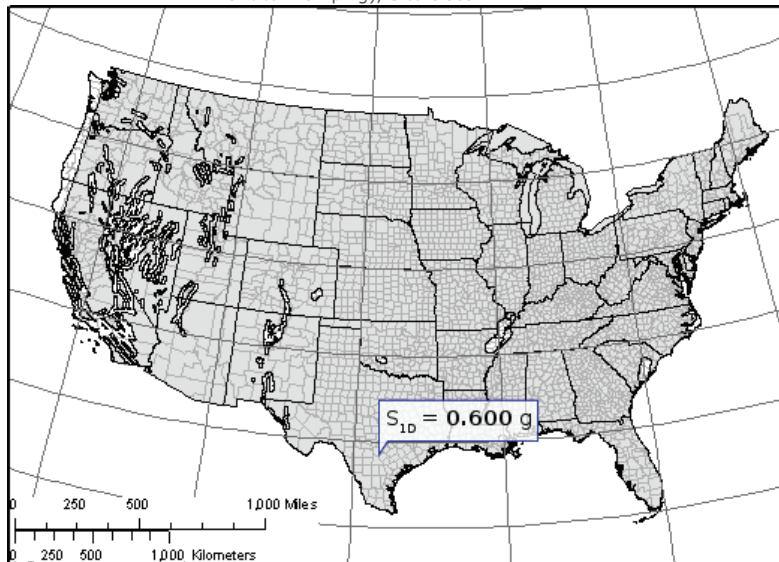

Figure 22-6: Deterministic Ground Motions of 1.0-Second Spectral Response Acceleration (5% of Critical Damping), Site Class B



Section 11.4.2 – Site Class

The authority having jurisdiction (not the USGS), site-specific geotechnical data, and/or the default has classified the site as Site Class D, based on the site soil properties in accordance with Chapter 20.

Table 20.3-1 Site Classification

Site Class	\bar{v}_s	\bar{N} or \bar{N}_{ch}	\bar{s}_u
A. Hard Rock	>5,000 ft/s	N/A	N/A
B. Rock	2,500 to 5,000 ft/s	N/A	N/A
C. Very dense soil and soft rock	1,200 to 2,500 ft/s	>50	>2,000 psf
D. Stiff Soil	600 to 1,200 ft/s	15 to 50	1,000 to 2,000 psf
E. Soft clay soil	<600 ft/s	<15	<1,000 psf

Any profile with more than 10 ft of soil having the characteristics:

- Plasticity index $PI > 20$,
- Moisture content $w \geq 40\%$, and
- Undrained shear strength $\bar{s}_u < 500$ psf

F. Soils requiring site response analysis in accordance with Section 21.1

See Section 20.3.1

For SI: 1ft/s = 0.3048 m/s 1lb/ft² = 0.0479 kN/m²

Section 11.4.3 – Site Coefficients, Risk Coefficients, and Risk-Targeted Maximum Considered Earthquake (MCE_R) Spectral Response Acceleration Parameters

Equation (11.4-1): $C_{RS} S_{SUH} = 0.892 \times 0.103 = 0.092 \text{ g}$

Equation (11.4-2): $S_{SD} = 1.500 \text{ g}$

$S_s \equiv \text{"Lesser of values from Equations (11.4-1) and (11.4-2)"} = 0.092 \text{ g}$

Equation (11.4-3): $C_{R1} S_{1UH} = 0.887 \times 0.035 = 0.031 \text{ g}$

Equation (11.4-4): $S_{1D} = 0.600 \text{ g}$

$S_1 \equiv \text{"Lesser of values from Equations (11.4-3) and (11.4-4)"} = 0.031 \text{ g}$

Table 11.4-1: Site Coefficient F_a

Site Class	Spectral Response Acceleration Parameter at Short Period				
	$S_s \leq 0.25$	$S_s = 0.5$	$S_s = 0.75$	$S_s = 1$	$S_s \geq 1.25$
A	0.8	0.8	0.8	0.8	0.8
B	1.0	1.0	1.0	1.0	1.0
C	1.2	1.2	1.1	1.0	1.0
D	1.6	1.4	1.2	1.1	1.0
E	2.5	1.7	1.2	0.9	0.9
F	See Section 11.4.7 of ASCE 7				

Note: Use straight-line interpolation for intermediate values of S_s

For Site Class = D and $S_s = 0.092$ g, $F_a = 1.600$

Table 11.4-2: Site Coefficient F_v

Site Class	Spectral Response Acceleration Parameter at 1-Second Period				
	$S_1 \leq 0.1$	$S_1 = 0.2$	$S_1 = 0.3$	$S_1 = 0.4$	$S_1 \geq 0.5$
A	0.8	0.8	0.8	0.8	0.8
B	1.0	1.0	1.0	1.0	1.0
C	1.7	1.6	1.5	1.4	1.3
D	2.4	2.0	1.8	1.6	1.5
E	3.5	3.2	2.8	2.4	2.4
F	See Section 11.4.7 of ASCE 7				

Note: Use straight-line interpolation for intermediate values of S_1

For Site Class = D and $S_1 = 0.031$ g, $F_v = 2.400$

Equation (11.4-5): $S_{MS} = F_a S_s = 1.600 \times 0.092 = 0.147 \text{ g}$

Equation (11.4-6): $S_{M1} = F_v S_1 = 2.400 \times 0.031 = 0.075 \text{ g}$

Section 11.4.4 – Design Spectral Acceleration Parameters

Equation (11.4-7): $S_{DS} = \frac{2}{3} S_{MS} = \frac{2}{3} \times 0.147 = 0.098 \text{ g}$

Equation (11.4-8): $S_{D1} = \frac{2}{3} S_{M1} = \frac{2}{3} \times 0.075 = 0.050 \text{ g}$

Section 11.4.5 – Design Response Spectrum

Figure 22-7: Long-period Transition Period, T_L (s)

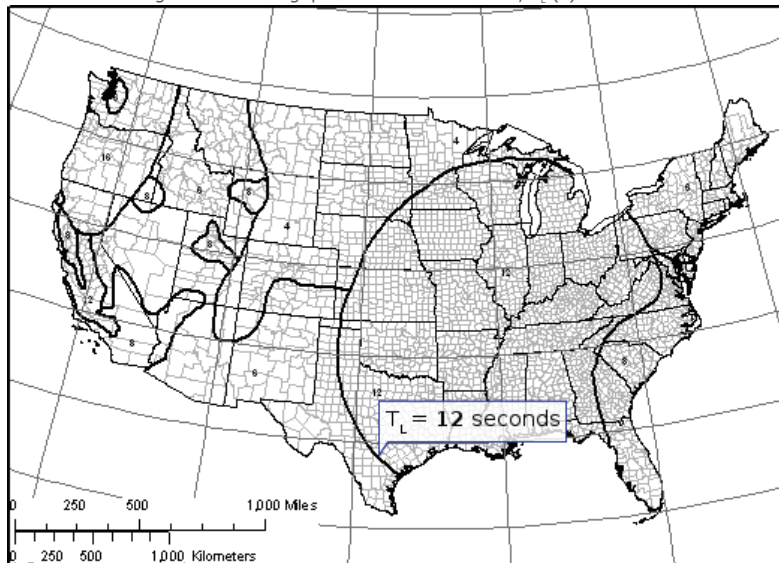

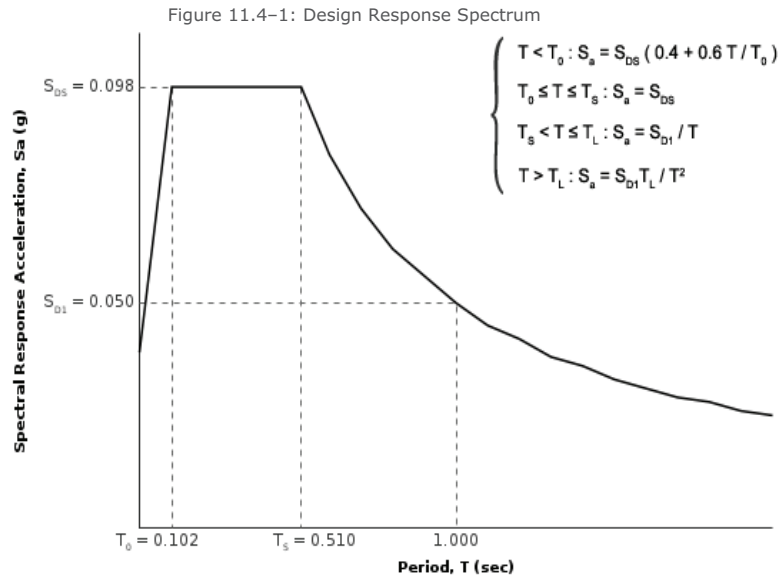

Section 11.4.6 — MCE_R Response Spectrum

The MCE_R response spectrum is determined by multiplying the design response spectrum above by 1.5.

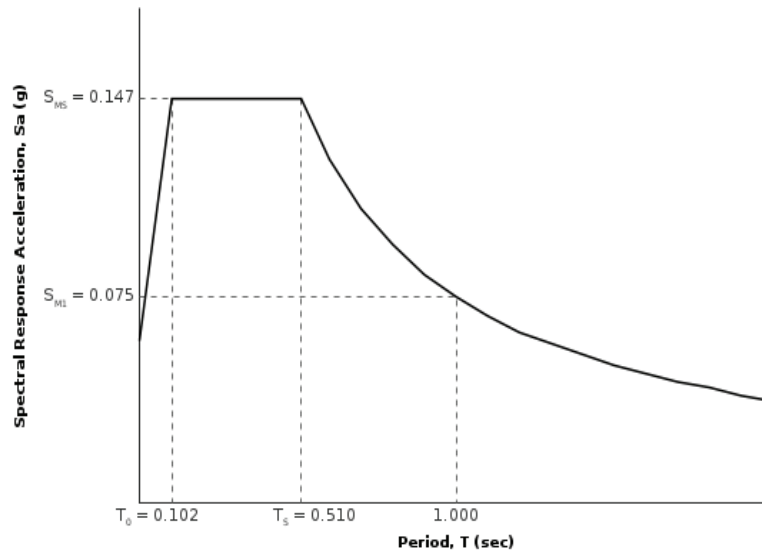

Section 11.8.3 – Additional Geotechnical Investigation Report Requirements for Seismic Design Categories D through F

Table 11.8-1: Site Coefficient F_{PGA}

Site Class	Mapped MCE Geometric Mean Peak Ground Acceleration, PGA				
	PGA ≤ 0.1	PGA = 0.2	PGA = 0.3	PGA = 0.4	PGA ≥ 0.5
A	0.8	0.8	0.8	0.8	0.8
B	1.0	1.0	1.0	1.0	1.0
C	1.2	1.2	1.1	1.0	1.0
D	1.6	1.4	1.2	1.1	1.0
E	2.5	1.7	1.2	0.9	0.9
F	See Section 11.4.7 of ASCE 7				

Note: Use straight-line interpolation for intermediate values of PGA

For Site Class = D and PGA = 0.047 g, $F_{PGA} = 1.600$

Mapped PGA

PGA = 0.047 g

Equation (11.8-1):

$$PGA_M = F_{PGA}PGA = 1.600 \times 0.047 = 0.075 \text{ g}$$

STRUCTURAL COMPONENTS AND SYSTEMS

For the Seismic Retrofit of Tilt-Up Buildings

[Home](#) [Mercalli XII](#) [Products](#) [Information](#) [Photos](#) [Contact](#)

[TERMS OF USE](#)

▶ [Information](#) ▶ Seismic Intensity Scales vs Peak Ground Acceleration

Seismic Intensity Scales vs Peak Ground Acceleration

Modified Mercalli Scale and PGA	
MMI	PGA (g)
IV	0.03 and below
V	0.03 - 0.08
VI	0.08 - 0.15
VII	0.15 - 0.25
VIII	0.25 - 0.45
IX	0.45 - 0.60
X	0.60 - 0.80
XI	0.80 - 0.90
XII	0.90 and above

The above table shows the approximate relationship between Modified Mercalli Intensity and Peak Ground Acceleration (PGA).

Richter Magnitude, PGA, and Duration		
Richter Magnitude	PGA (g)	Duration (seconds)
5.0	0.09	2
5.5	0.15	6
6.0	0.22	12

<http://mercallixii.com/information/15-the-richter-scale.html>

11/19/2012

6.5	0.29	18
7.0	0.37	24
7.5	0.45	30
8.0	0.50	34
8.5	0.50	37



The above table shows the approximate relationship between Richter Magnitude, Peak Ground Acceleration (PGA), and duration of strong-phase shaking near the epicenter of earthquakes located in California.

[< Prev](#) [Next >](#)

[Home](#) | [About Mercalli XII](#) | [Contact](#) | [Terms of Use](#)

Copyright © 2004-2012, Mercalli XII, Inc. All Rights Reserved

Global Stability Analysis

Material Name	Color	Unit Weight (lbs/ft ³)	Strength Type	Cohesion (psf)	Phi (deg)
Embankment Fill		120	Mohr-Coulomb	350	20
Clayey Sand		120	Mohr-Coulomb	400	20
Clayey Sand Below WT		57.6	Mohr-Coulomb	400	20

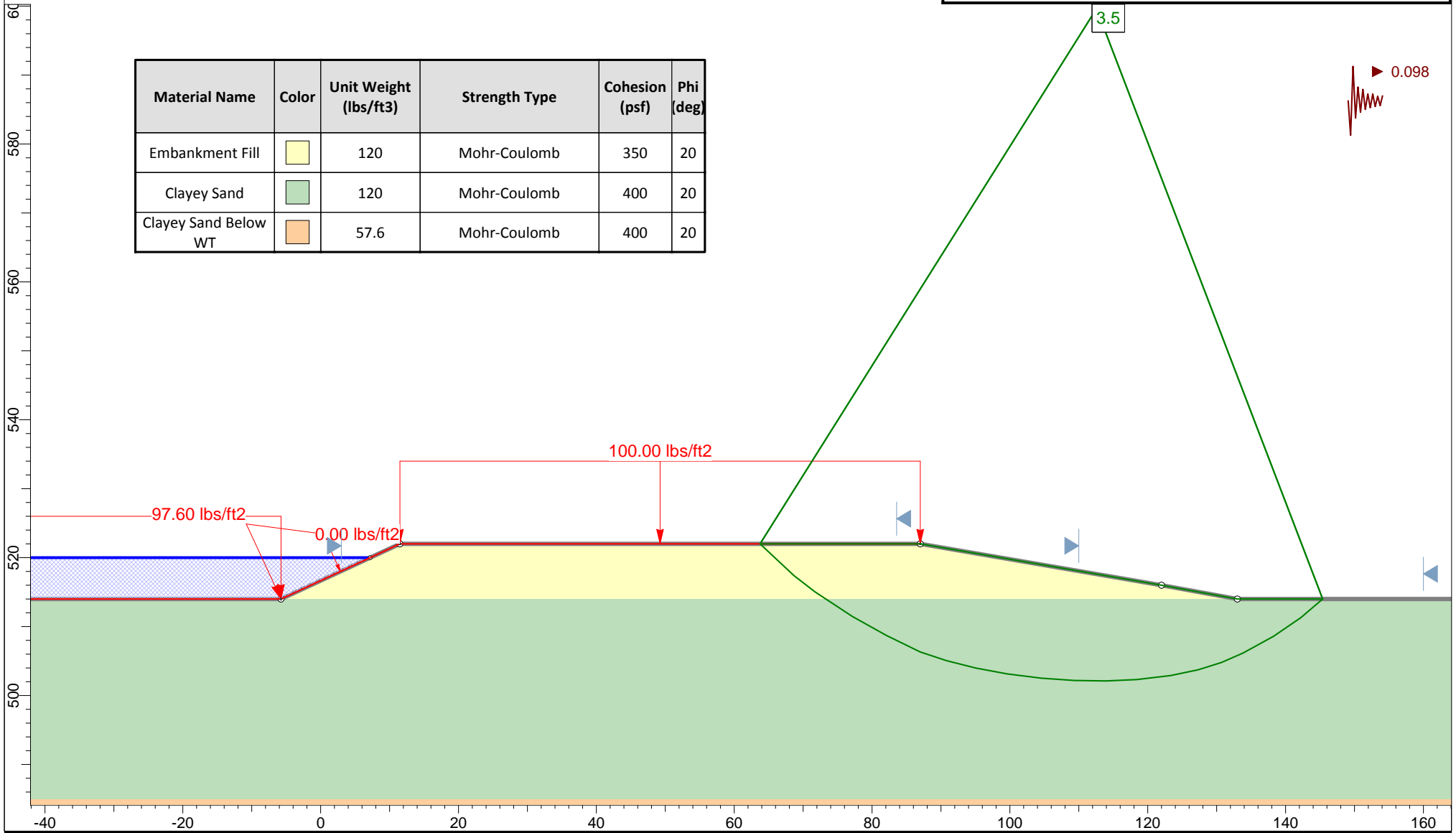

Profile "A" - Steady State
Ash Pond Berms - Spruce/Deely Generation Units

Raba Kistner Consultants, Inc.
ASA12-098-00

Figure D-14a



Global Stability Analysis

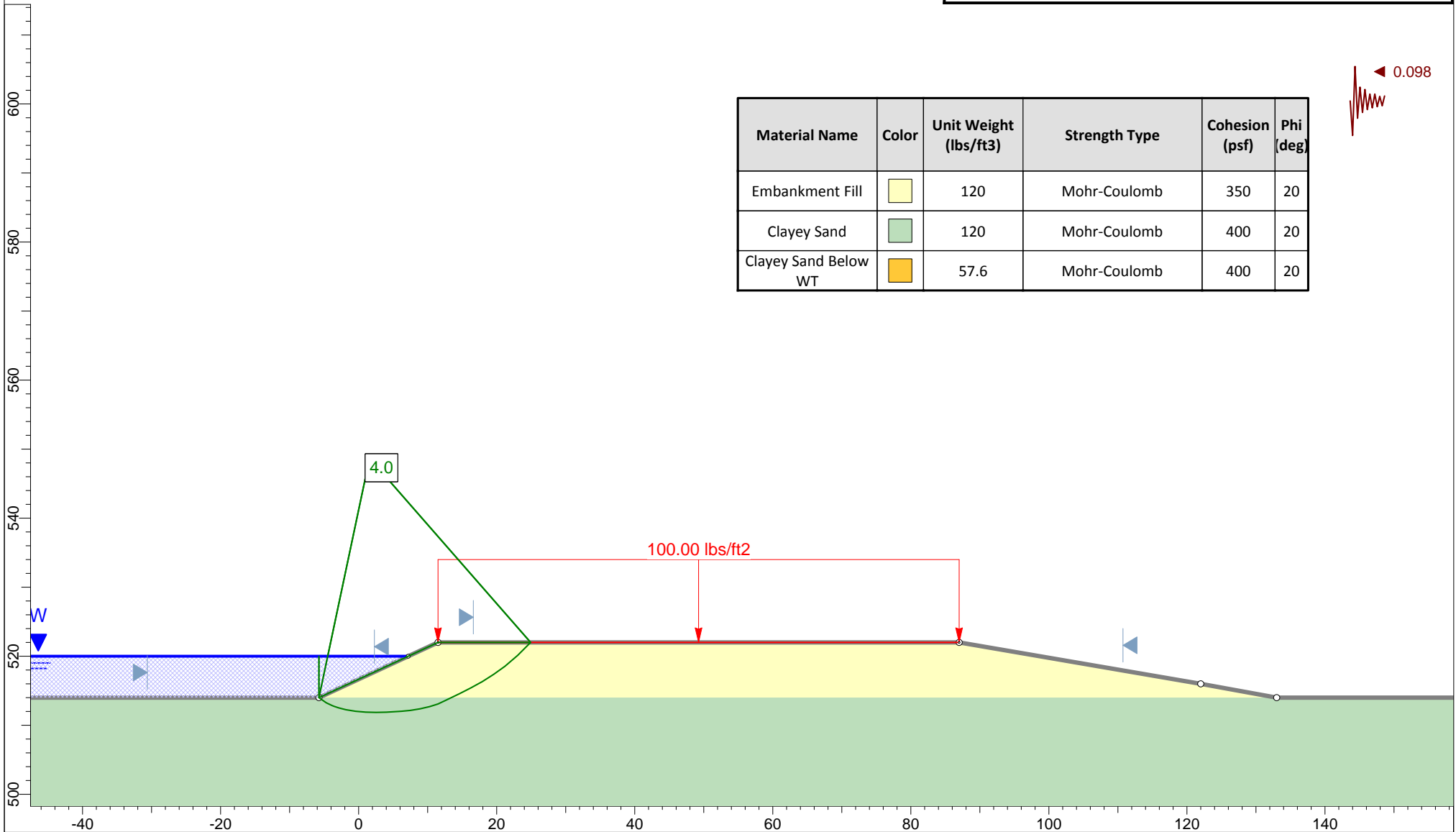





Profile "A" - Steady State
Ash Pond Berms - Spruce/Deely Generation Units

Raba Kistner Consultants, Inc.
ASA12-098-00

Figure D-14b



Global Stability Analysis

Material Name	Color	Unit Weight (lbs/ft3)	Strength Type	Cohesion (psf)	Phi (deg)
Embankment Fill		120	Mohr-Coulomb	350	20
Clayey Sand		120	Mohr-Coulomb	400	20
Sandy Clay		120	Mohr-Coulomb	500	20
Clayey Sand Below WT		57.6	Mohr-Coulomb	400	20

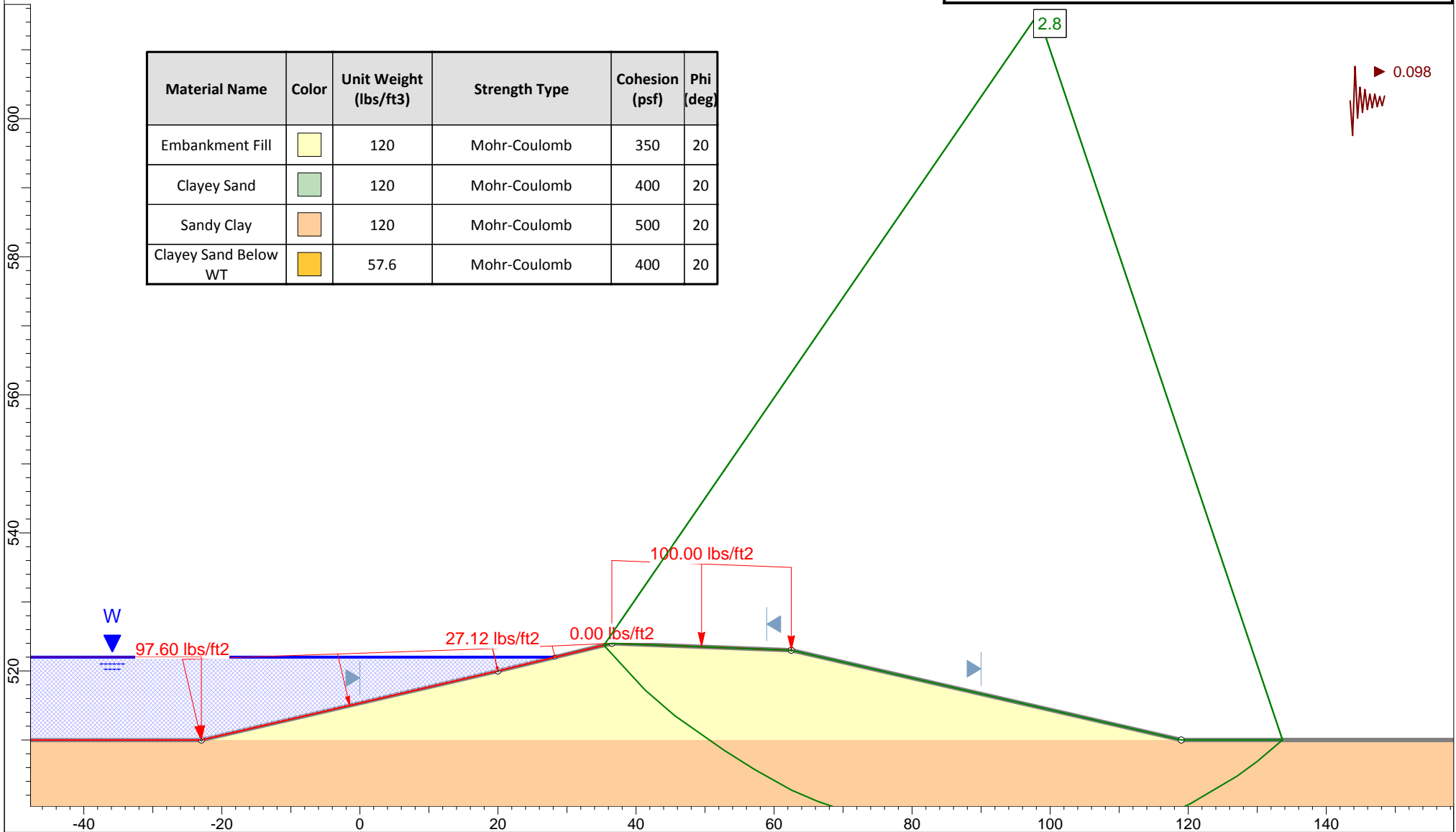

Profile "B" - Steady State
Ash Pond Berms - Spruce/Deely Generation Units





Raba Kistner Consultants, Inc.
ASA12-098-00

Figure D-15a

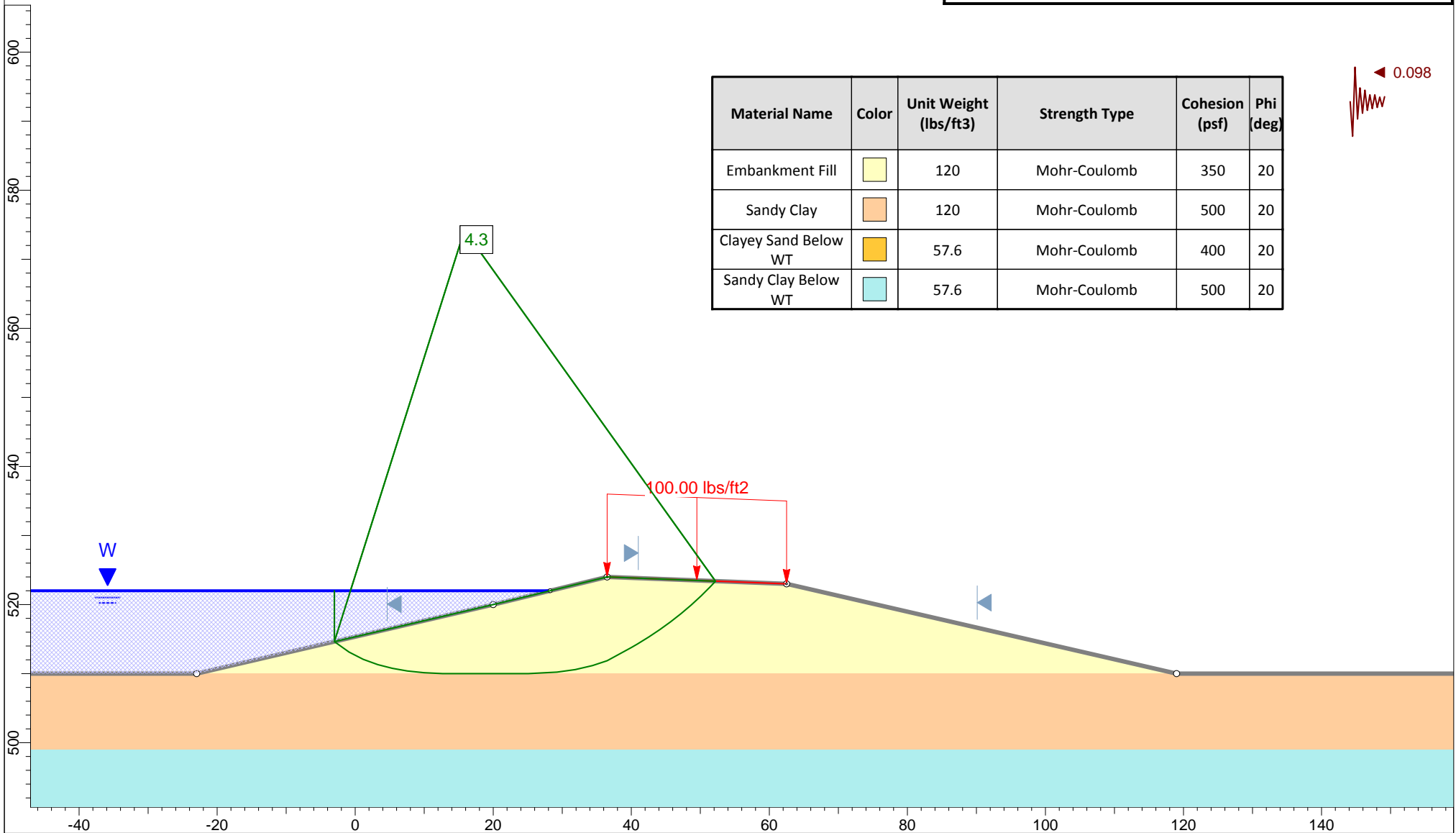

Global Stability Analysis



Material Name	Color	Unit Weight (lbs/ft3)	Strength Type	Cohesion (psf)	Phi (deg)
Embankment Fill		120	Mohr-Coulomb	350	20
Sandy Clay		120	Mohr-Coulomb	500	20
Clayey Sand Below WT		57.6	Mohr-Coulomb	400	20
Sandy Clay Below WT		57.6	Mohr-Coulomb	500	20



Profile "B" - Steady State
Ash Pond Berms - Spruce/Deely Generation Units

Raba Kistner Consultants, Inc.
ASA12-098-00

Figure D-15b



Global Stability Analysis

Material Name	Color	Unit Weight (lbs/ft ³)	Strength Type	Cohesion (psf)	Phi (deg)
Embankment Fill		120	Mohr-Coulomb	350	20
Clayey Sand		120	Mohr-Coulomb	400	20
Clayey Sand Below WT		57.6	Mohr-Coulomb	400	20

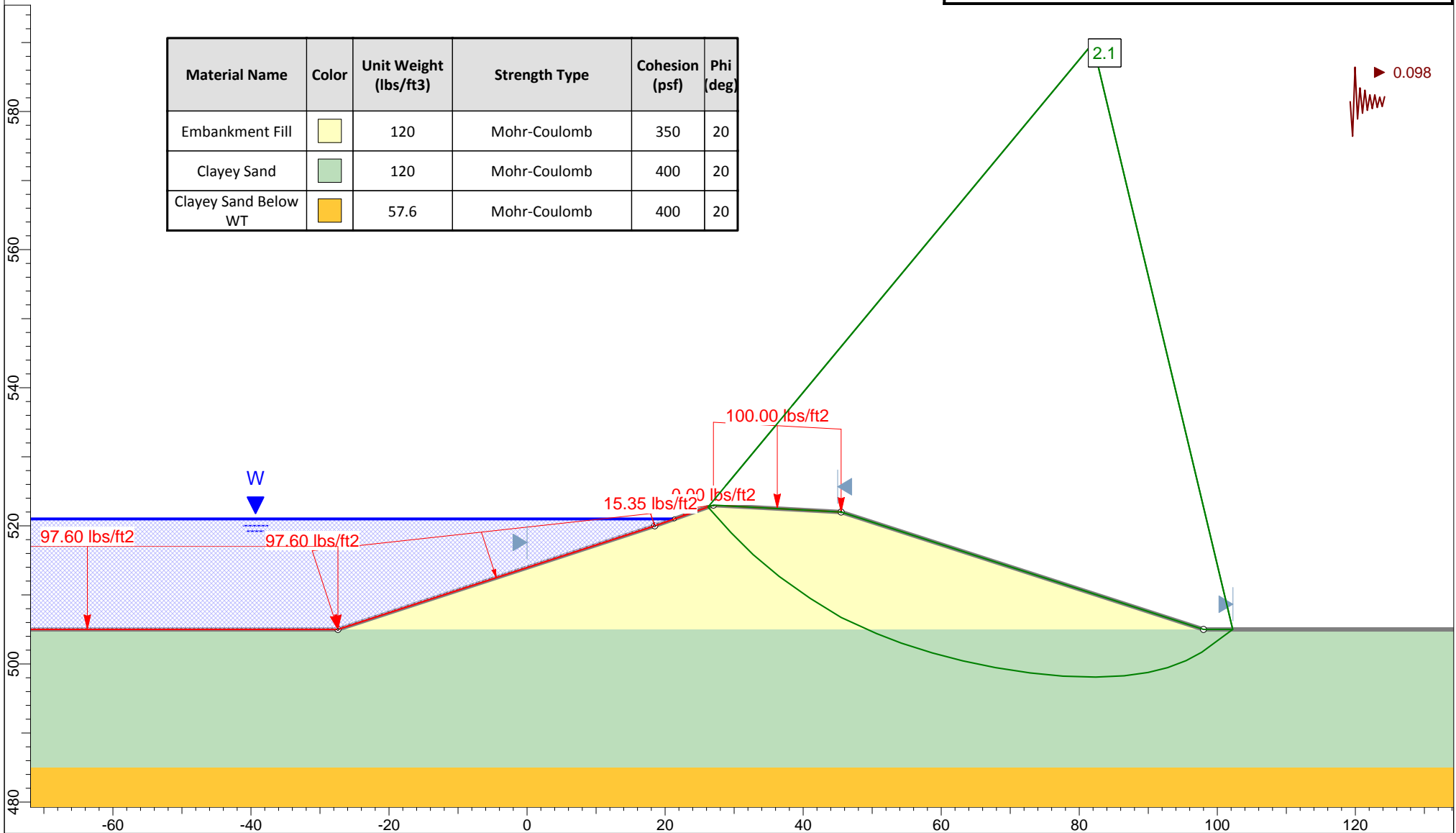

Profile "C" - Steady State
Ash Pond Berms - Spruce/Deely Generation Units

Raba Kistner Consultants, Inc.
ASA12-098-00

Figure D-16a



Global Stability Analysis

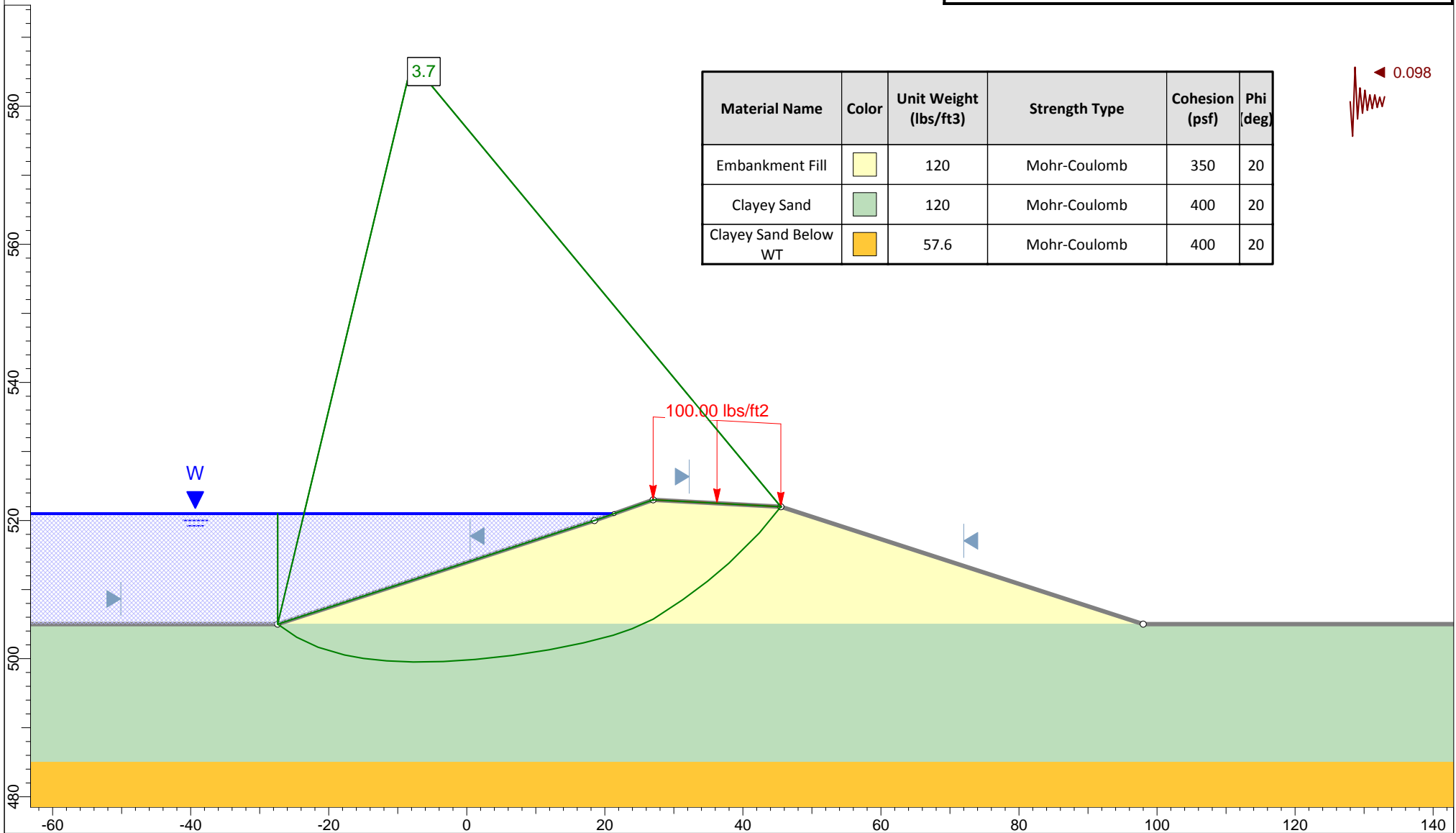

Material Name	Color	Unit Weight (lbs/ft3)	Strength Type	Cohesion (psf)	Phi (deg)
Embankment Fill	Yellow	120	Mohr-Coulomb	350	20
Clayey Sand	Green	120	Mohr-Coulomb	400	20
Clayey Sand Below WT	Orange	57.6	Mohr-Coulomb	400	20

0.098





Profile "C" - Steady State
Ash Pond Berms - Spruce/Deely Generation Units

Raba Kistner Consultants, Inc.
ASA12-098-00

Figure D-16b



Global Stability Analysis

Material Name	Color	Unit Weight (lbs/ft ³)	Strength Type	Cohesion (psf)	Phi (deg)
Embankment Fill		120	Mohr-Coulomb	350	20
Clayey Sand		120	Mohr-Coulomb	400	20
Sandy Clay		120	Mohr-Coulomb	500	20
Clayey Sand Below WT		57.6	Mohr-Coulomb	400	20

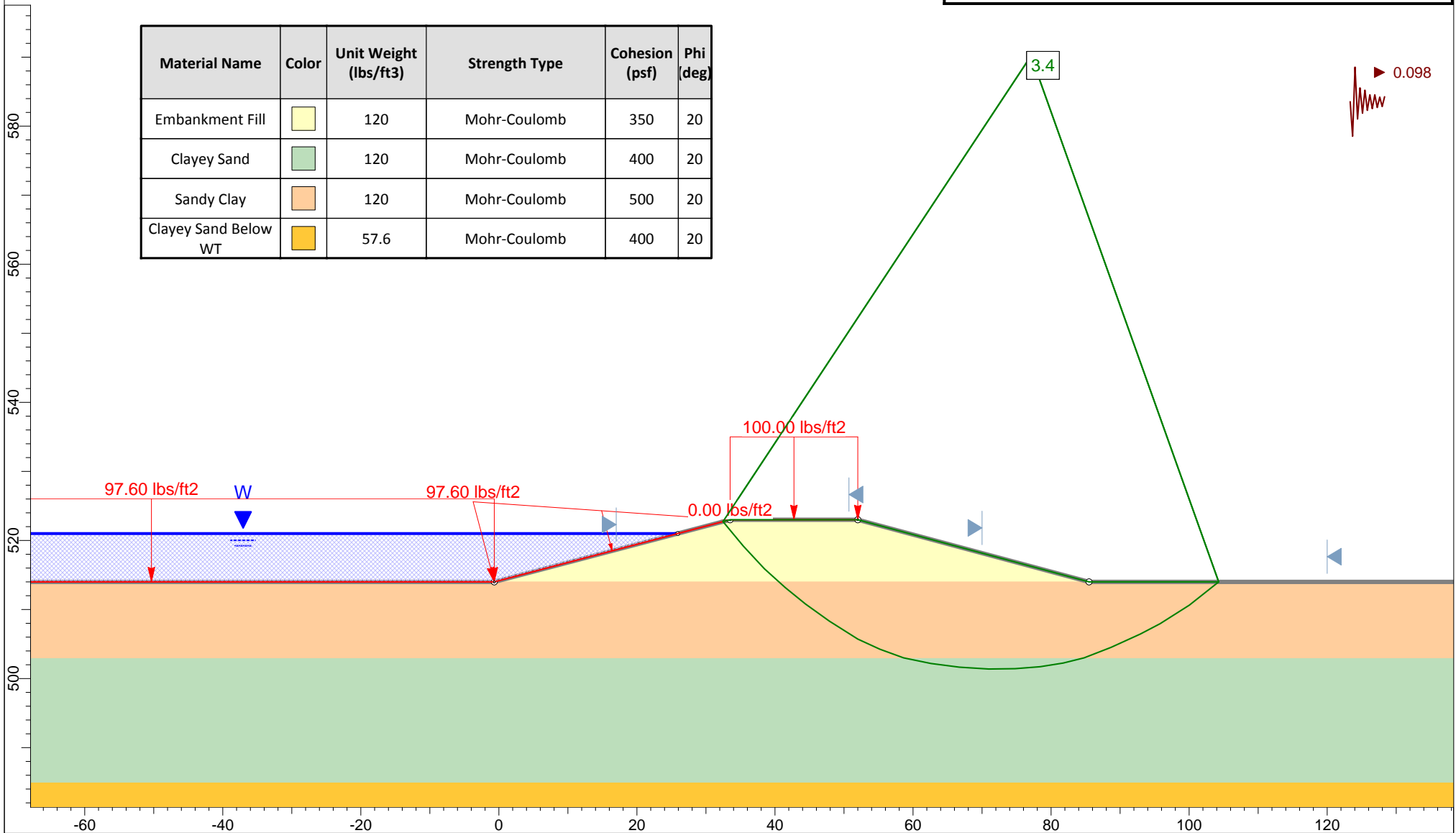





Profile "D" - Steady State
Ash Pond Berms - Spruce/Deely Generation Units

Raba Kistner Consultants, Inc.
ASA12-098-00

Figure D-17a



Global Stability Analysis

Material Name	Color	Unit Weight (lbs/ft ³)	Strength Type	Cohesion (psf)	Phi (deg)
Embankment Fill		120	Mohr-Coulomb	350	20
Clayey Sand		120	Mohr-Coulomb	400	20
Sandy Clay		120	Mohr-Coulomb	500	20
Clayey Sand Below WT		57.6	Mohr-Coulomb	400	20

 0.098

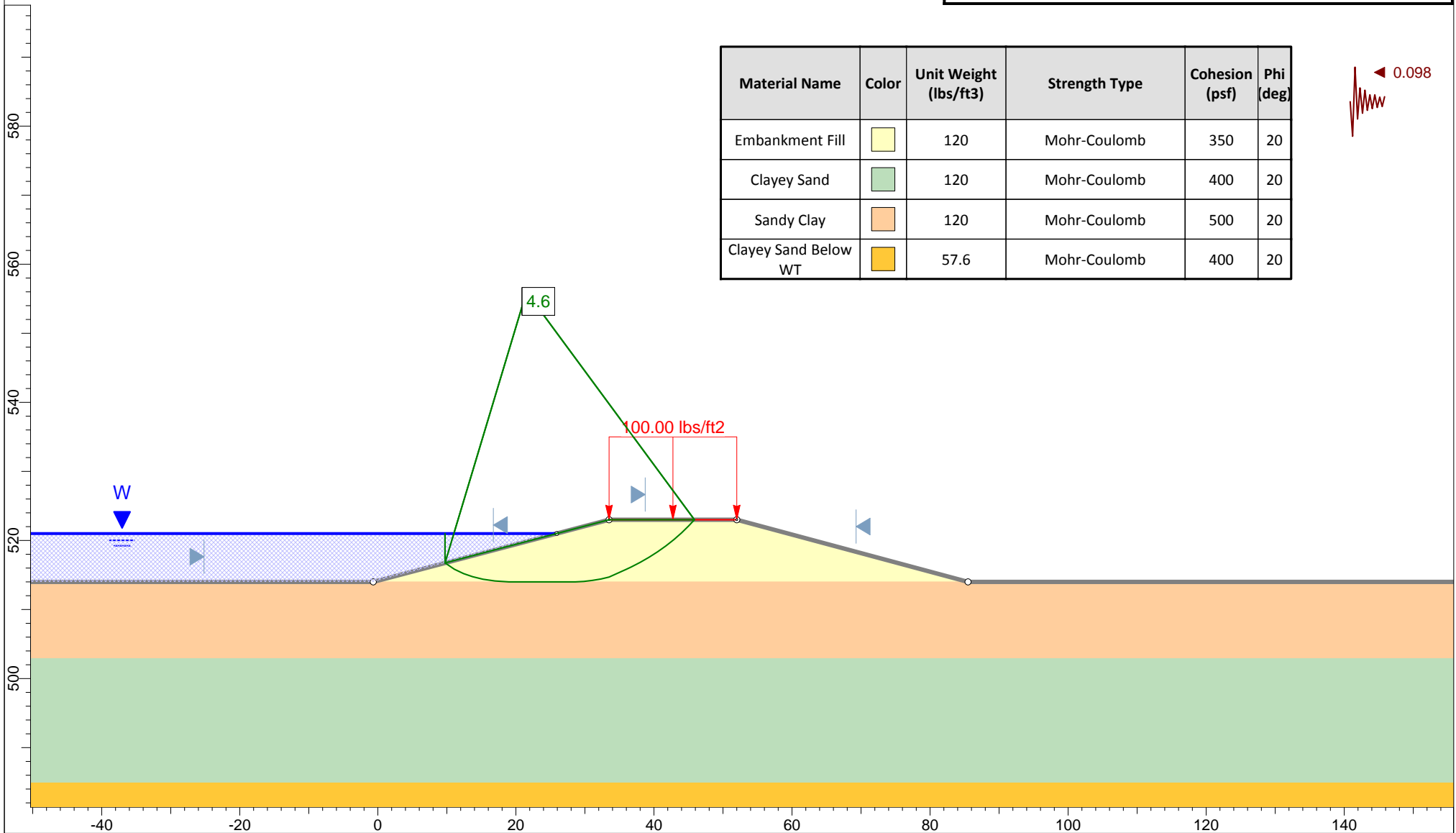



Profile "D" - Steady State
Ash Pond Berms - Spruce/Deely Generation Units

Raba Kistner Consultants, Inc.
ASA12-098-00

Figure D-17b



Global Stability Analysis

Material Name	Color	Unit Weight (lbs/ft ³)	Strength Type	Cohesion (psf)	Phi (deg)
Embankment Soil		120	Mohr-Coulomb	350	20
Sandy Clay		120	Mohr-Coulomb	500	20
Clayey Sand Below WT		57.6	Mohr-Coulomb	400	20

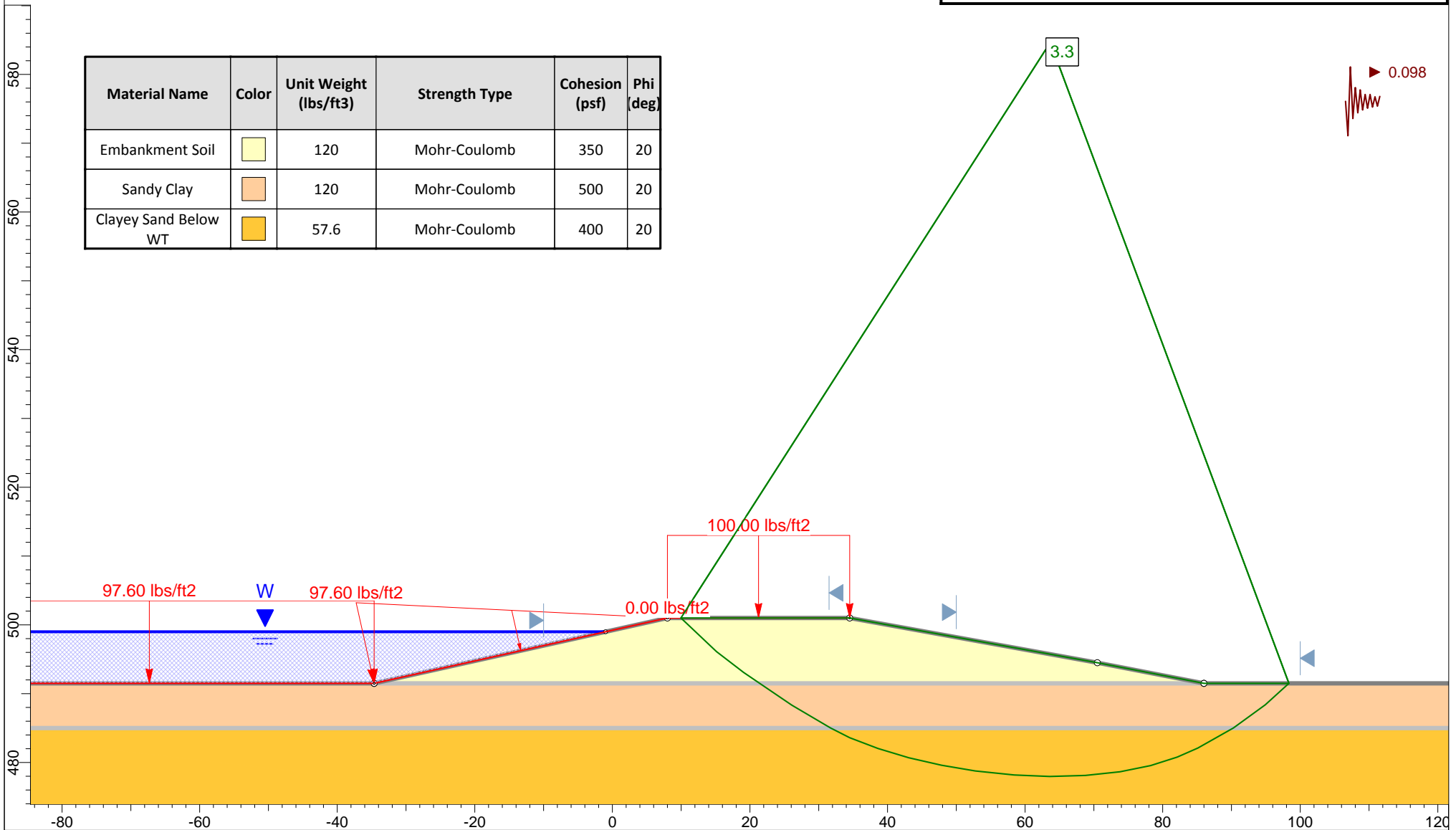

Profile "E" - Steady State
Ash Pond Berms - Spruce/Deely Generation Units

Raba Kistner Consultants, Inc.
ASA12-098-00

Figure D-18a



Global Stability Analysis

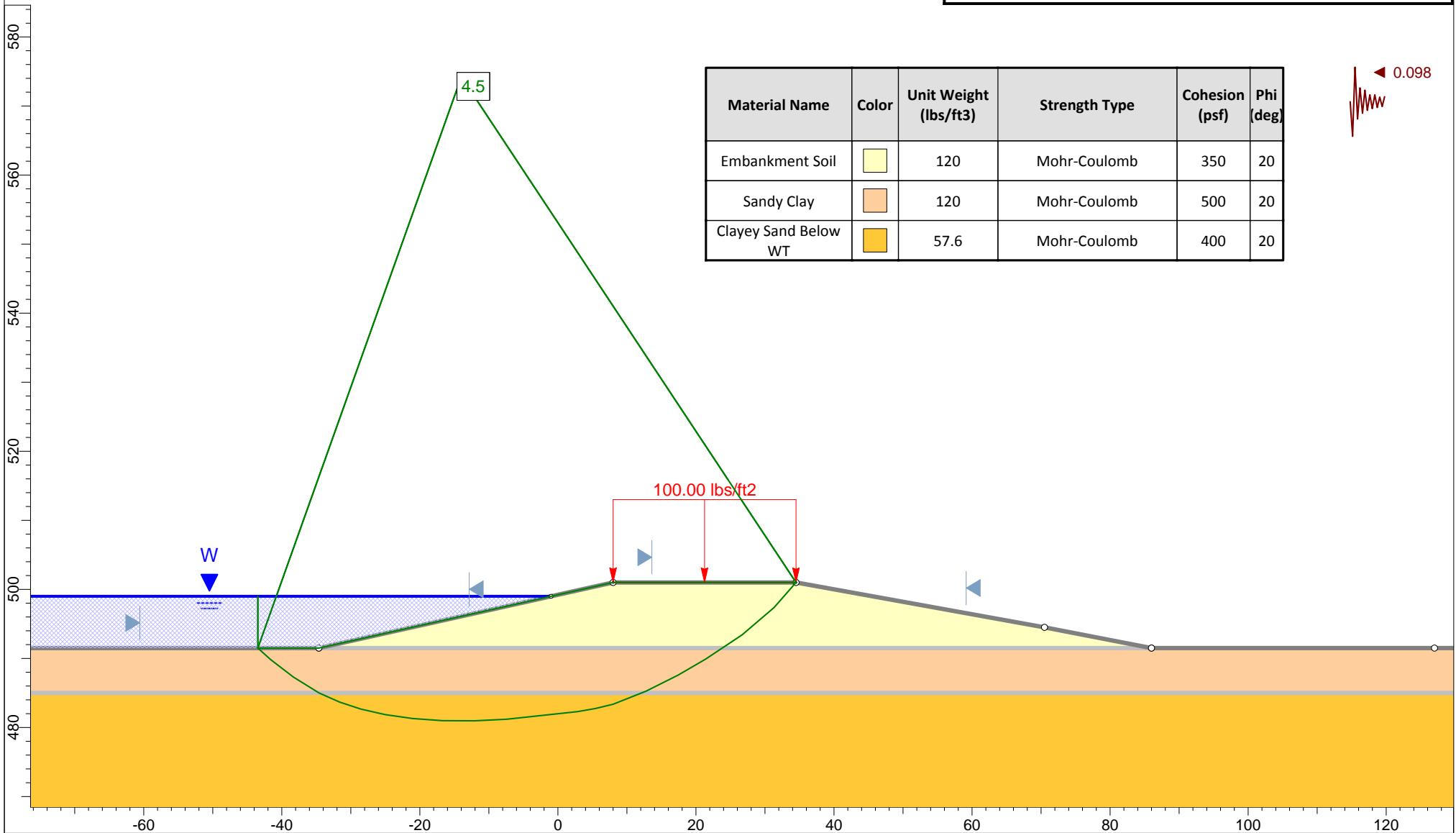





Profile "E" - Steady State
Ash Pond Berms - Spruce/Deely Generation Units

Raba Kistner Consultants, Inc.
ASA12-098-00

Figure D-18b



Global Stability Analysis

Material Name	Color	Unit Weight (lbs/ft ³)	Strength Type	Cohesion (psf)	Phi (deg)
Embankment Fill		120	Mohr-Coulomb	350	20
Clayey Sand		120	Mohr-Coulomb	400	20
Clayey Sand Below WT		57.6	Mohr-Coulomb	400	20
Sandy Clay Below WT		57.6	Mohr-Coulomb	500	20

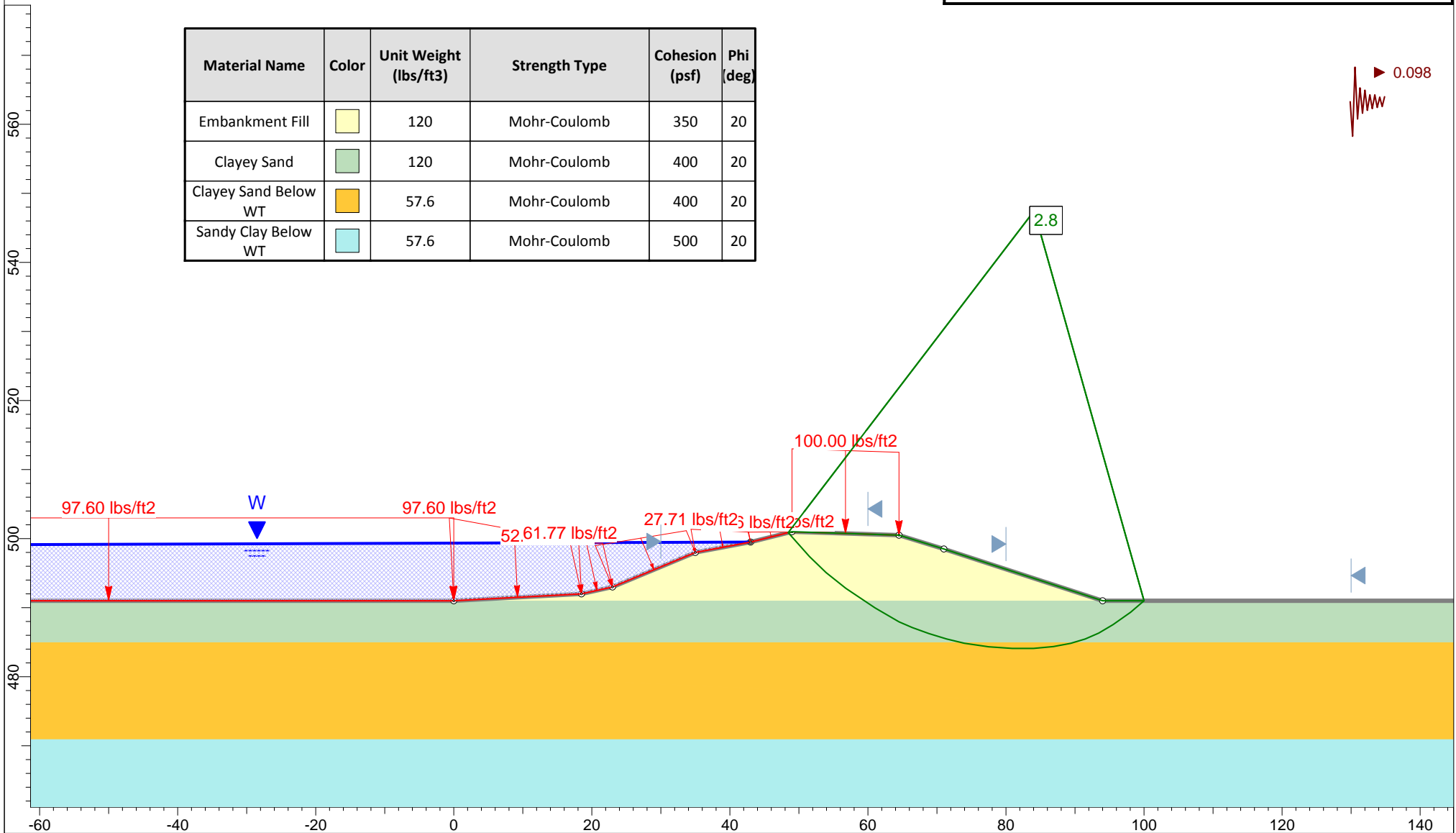

Profile "F" - Steady State
Ash Pond Berms - Spruce/Deely Generation Units

Raba Kistner Consultants, Inc.
ASA12-098-00

Figure D-19a



Global Stability Analysis

Material Name	Color	Unit Weight (lbs/ft ³)	Strength Type	Cohesion (psf)	Phi (deg)
Embankment Fill	Yellow	120	Mohr-Coulomb	350	20
Clayey Sand	Green	120	Mohr-Coulomb	400	20
Clayey Sand Below WT	Orange	57.6	Mohr-Coulomb	400	20
Sandy Clay Below WT	Cyan	57.6	Mohr-Coulomb	500	20

◀ 0.098

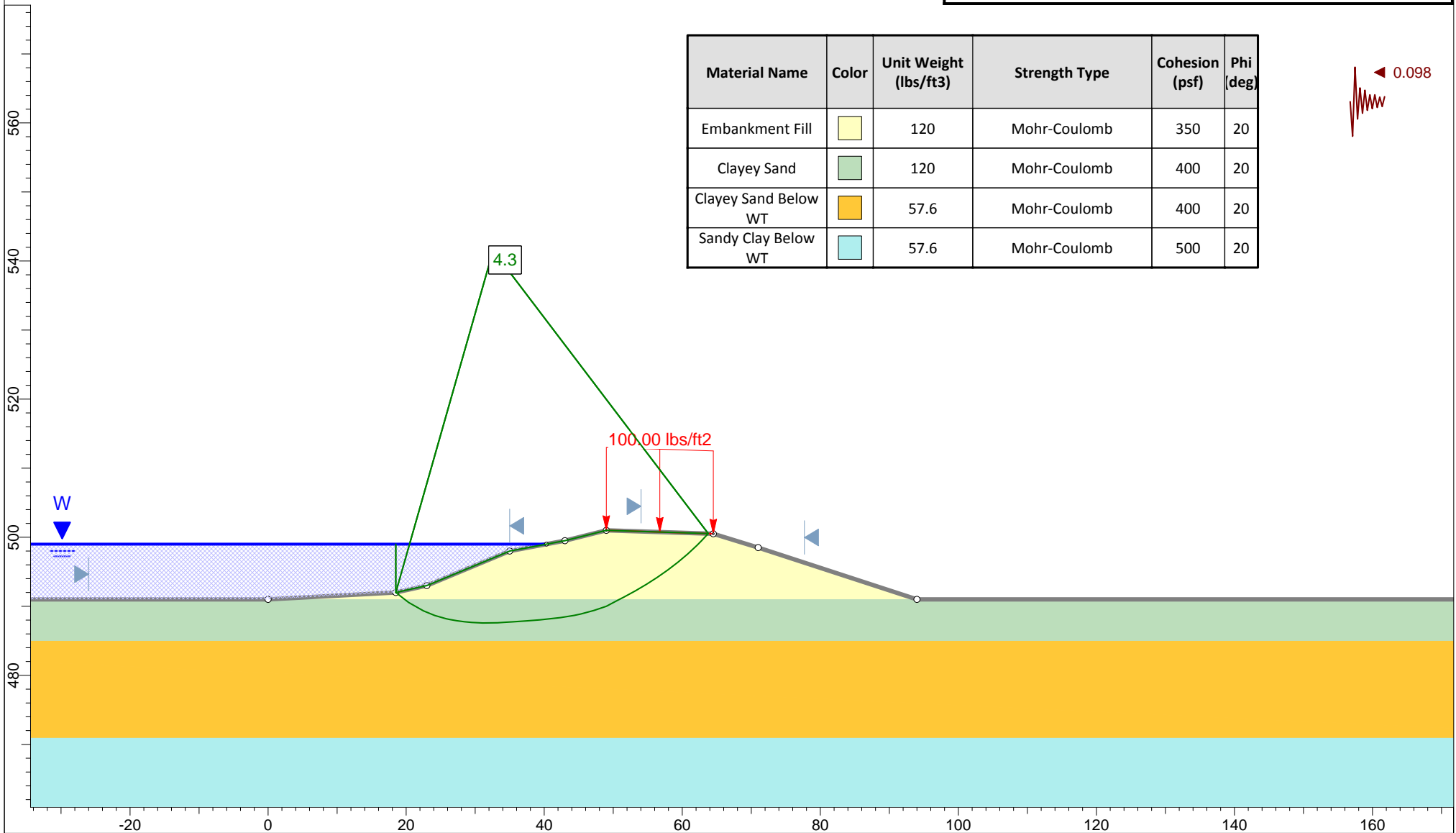



Profile "F" - Steady State
Ash Pond Berms - Spruce/Deely Generation Units

Raba Kistner Consultants, Inc.
ASA12-098-00

Figure D-19b



Global Stability Analysis

Material Name	Color	Unit Weight (lbs/ft ³)	Strength Type	Cohesion (psf)	Phi (deg)
Embankment Fill		120	Mohr-Coulomb	350	20
Clayey Sand Below WT		57.6	Mohr-Coulomb	400	20
Sandy Clay Below WT		57.6	Mohr-Coulomb	500	20

 0.098

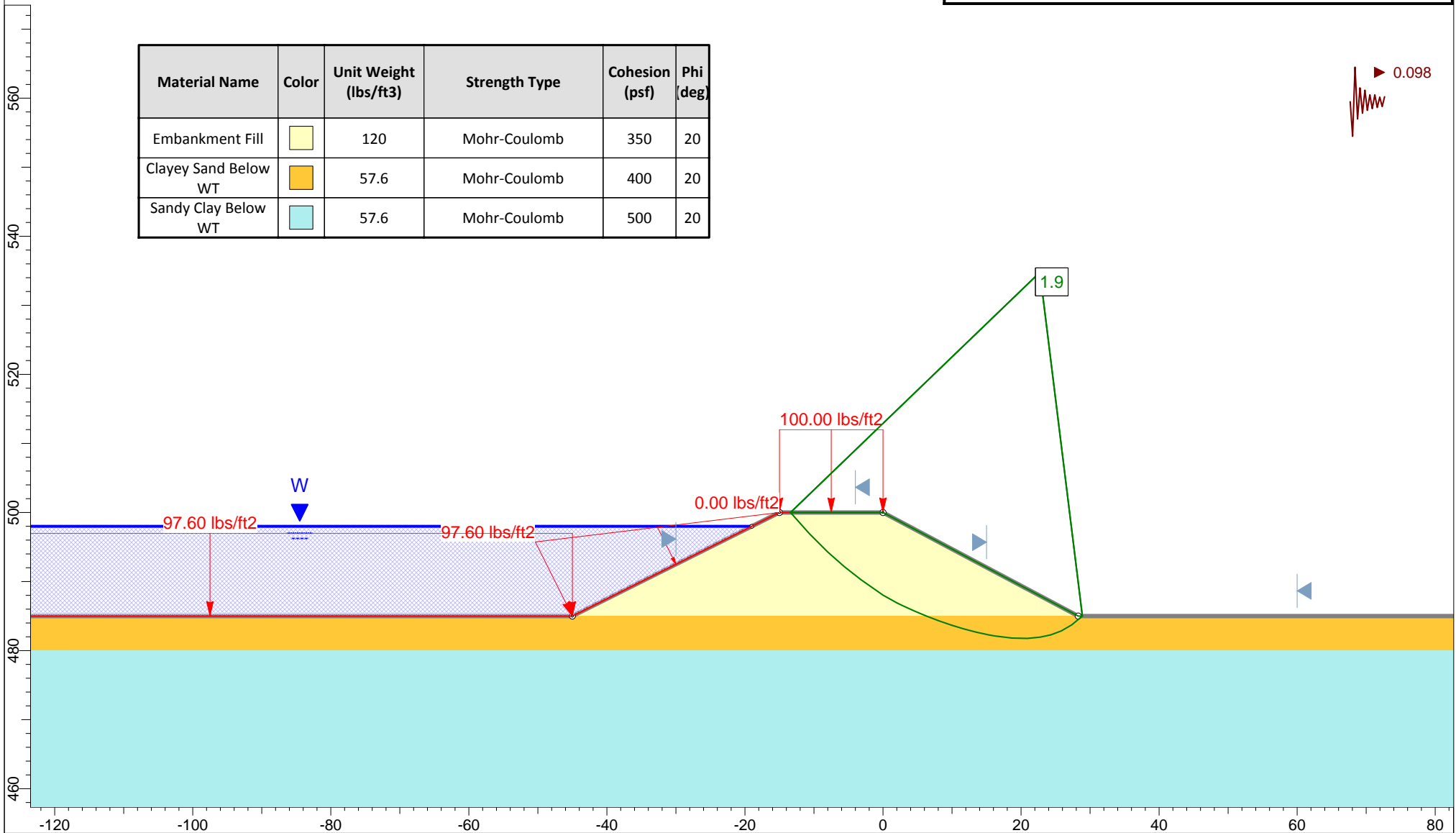

Profile "G" - Steady State
Ash Pond Berms - Spruce/Deely Generation Units

Raba Kistner Consultants, Inc.
ASA12-098-00

Figure D-20a



Global Stability Analysis

Material Name	Color	Unit Weight (lbs/ft ³)	Strength Type	Cohesion (psf)	Phi (deg)
Embankment Fill	Yellow	120	Mohr-Coulomb	350	20
Clayey Sand Below WT	Orange	57.6	Mohr-Coulomb	400	20
Sandy Clay Below WT	Light Blue	57.6	Mohr-Coulomb	500	20

◀ 0.098

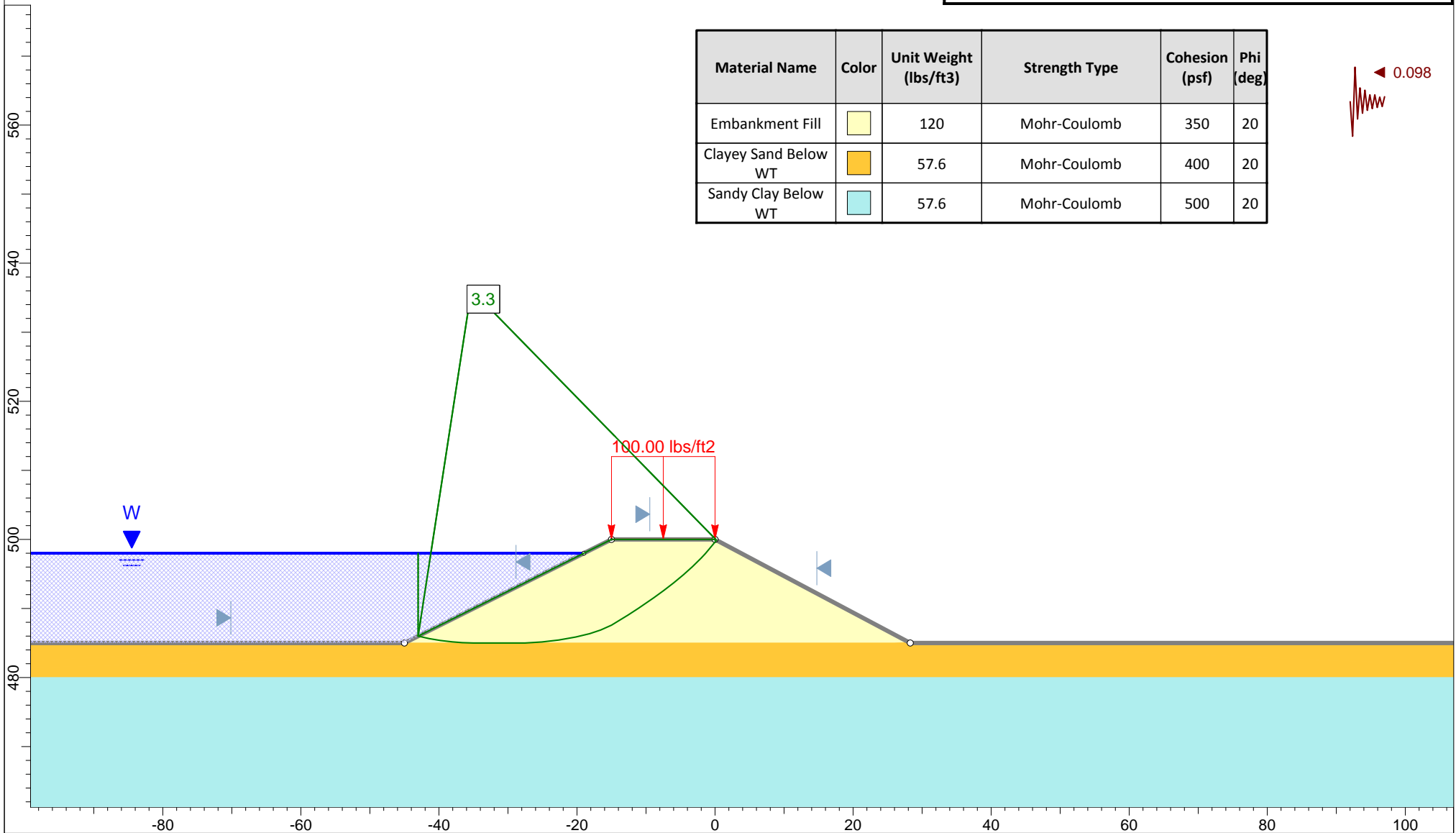





Profile "G" - Steady State
Ash Pond Berms - Spruce/Deely Generation Units

Raba Kistner Consultants, Inc.
ASA12-098-00

Figure D-20b



Global Stability Analysis

Material Name	Color	Unit Weight (lbs/ft ³)	Strength Type	Cohesion (psf)	Phi (deg)
Embankment Fill		120	Mohr-Coulomb	350	20
Sandy Clay		120	Mohr-Coulomb	500	20
Clayey Sand Below WT		57.6	Mohr-Coulomb	400	20
Sandy Clay Below WT		57.6	Mohr-Coulomb	500	20

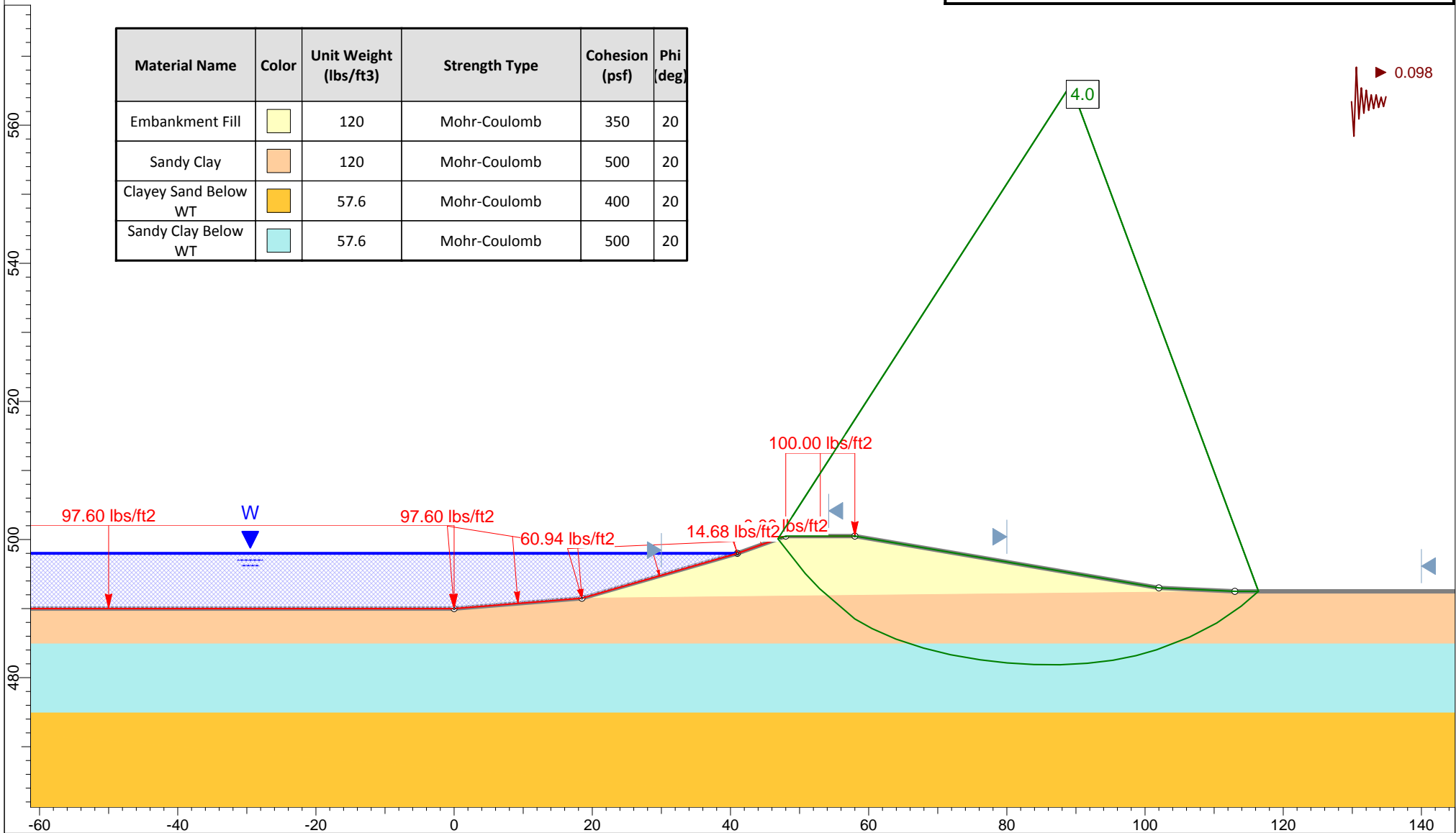





Profile "H" - Steady State
Ash Pond Berms - Spruce/Deely Generation Units

Raba Kistner Consultants, Inc.
ASA12-098-00

Figure D-21a



Global Stability Analysis

Material Name	Color	Unit Weight (lbs/ft ³)	Strength Type	Cohesion (psf)	Phi (deg)
Embankment Fill		120	Mohr-Coulomb	350	20
Sandy Clay		120	Mohr-Coulomb	500	20
Clayey Sand Below WT		57.6	Mohr-Coulomb	400	20
Sandy Clay Below WT		57.6	Mohr-Coulomb	500	20

 0.098

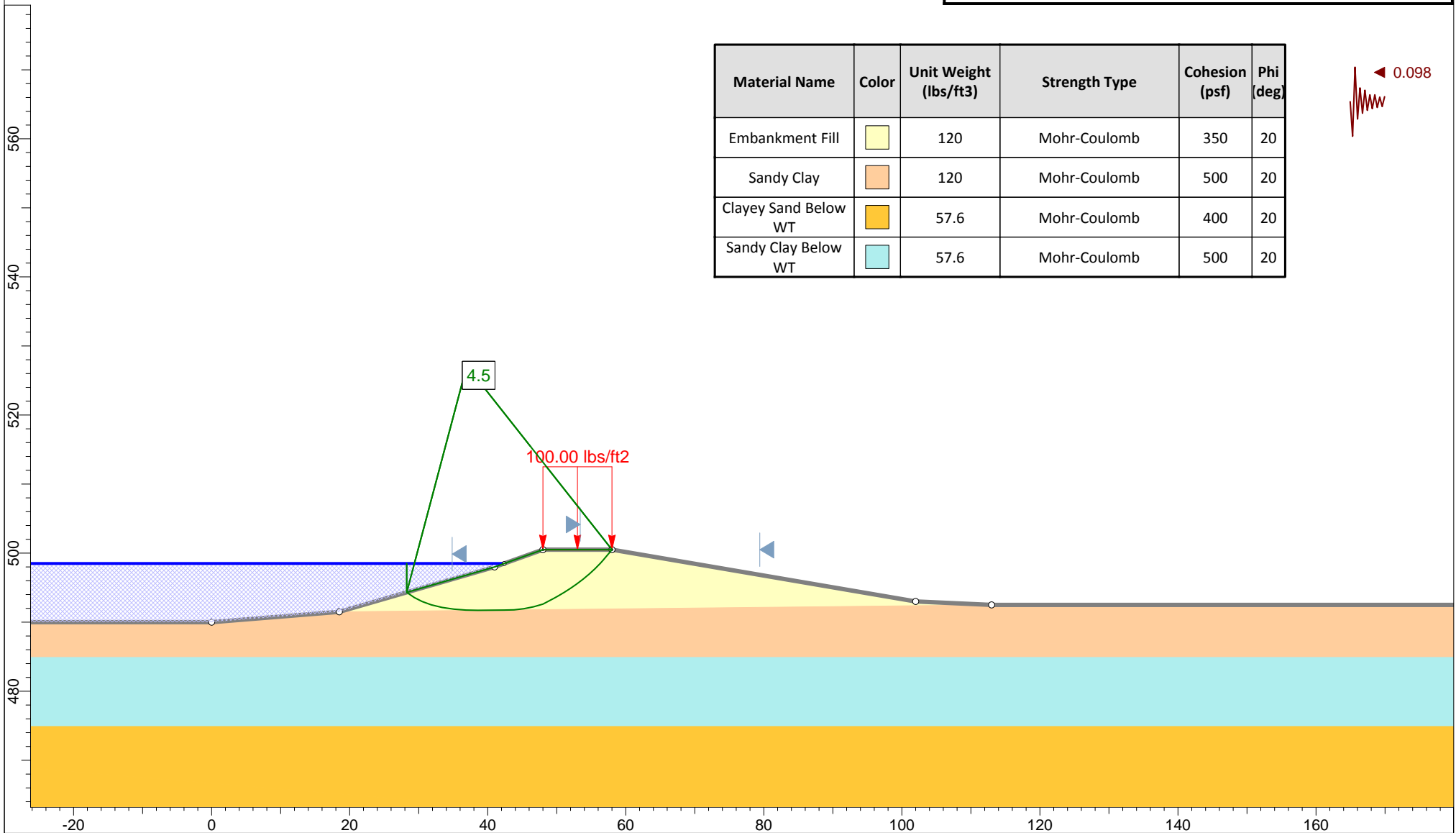



Profile "H" - Steady State
Ash Pond Berms - Spruce/Deely Generation Units

Raba Kistner Consultants, Inc.
ASA12-098-00

Figure D-21b



Global Stability Analysis

Material Name	Color	Unit Weight (lbs/ft ³)	Strength Type	Cohesion (psf)	Phi (deg)
Embankment Fill		120	Mohr-Coulomb	350	20
Sandy Clay		120	Mohr-Coulomb	500	20
Clayey Sand Below WT		57.6	Mohr-Coulomb	400	20
Sandy Clay Below WT		57.6	Mohr-Coulomb	500	20

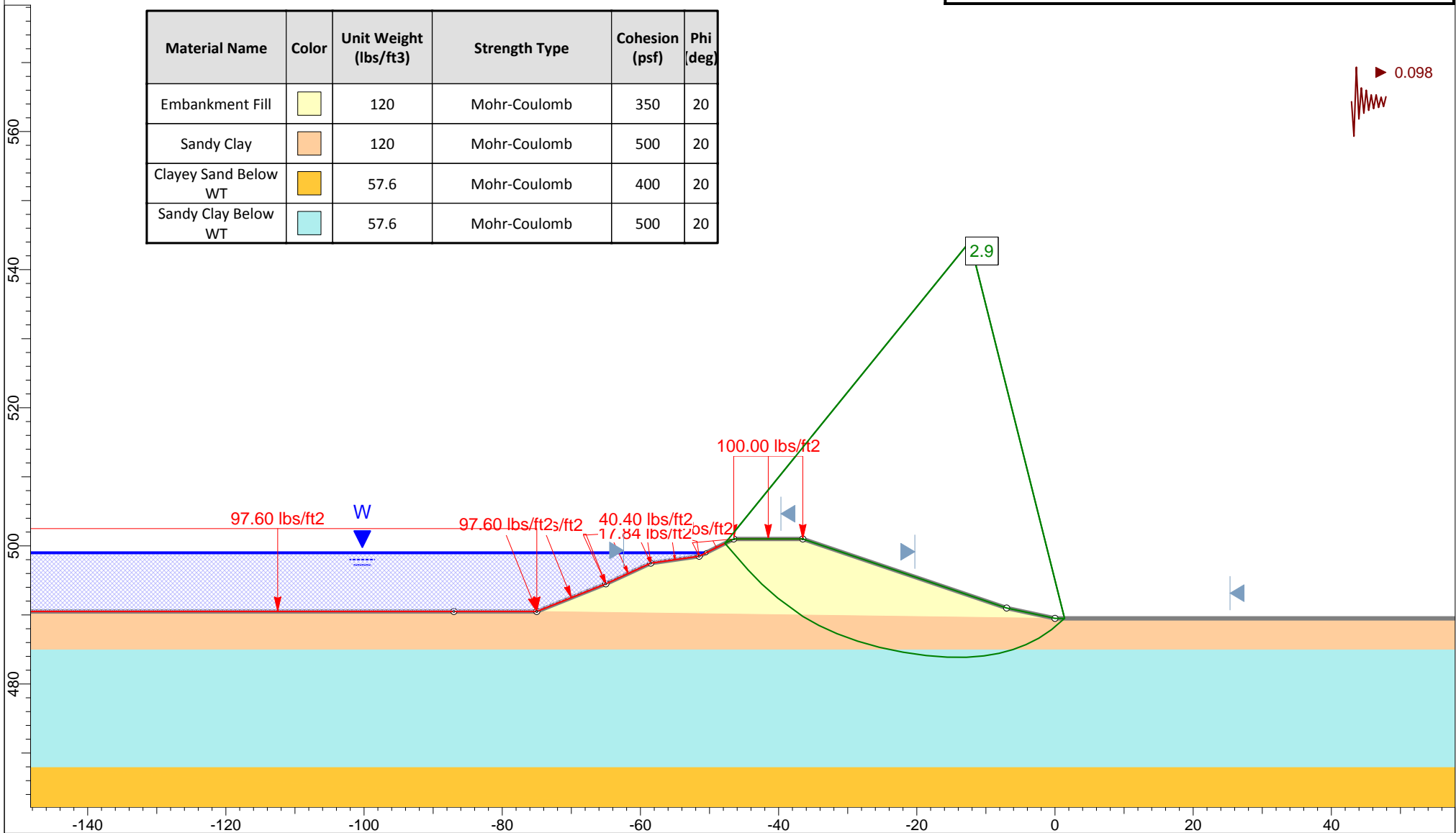

Profile "I" - Steady State
Ash Pond Berms - Spruce/Deely Generation Units

Raba Kistner Consultants, Inc.
ASA12-098-00

Figure D-22a



Global Stability Analysis

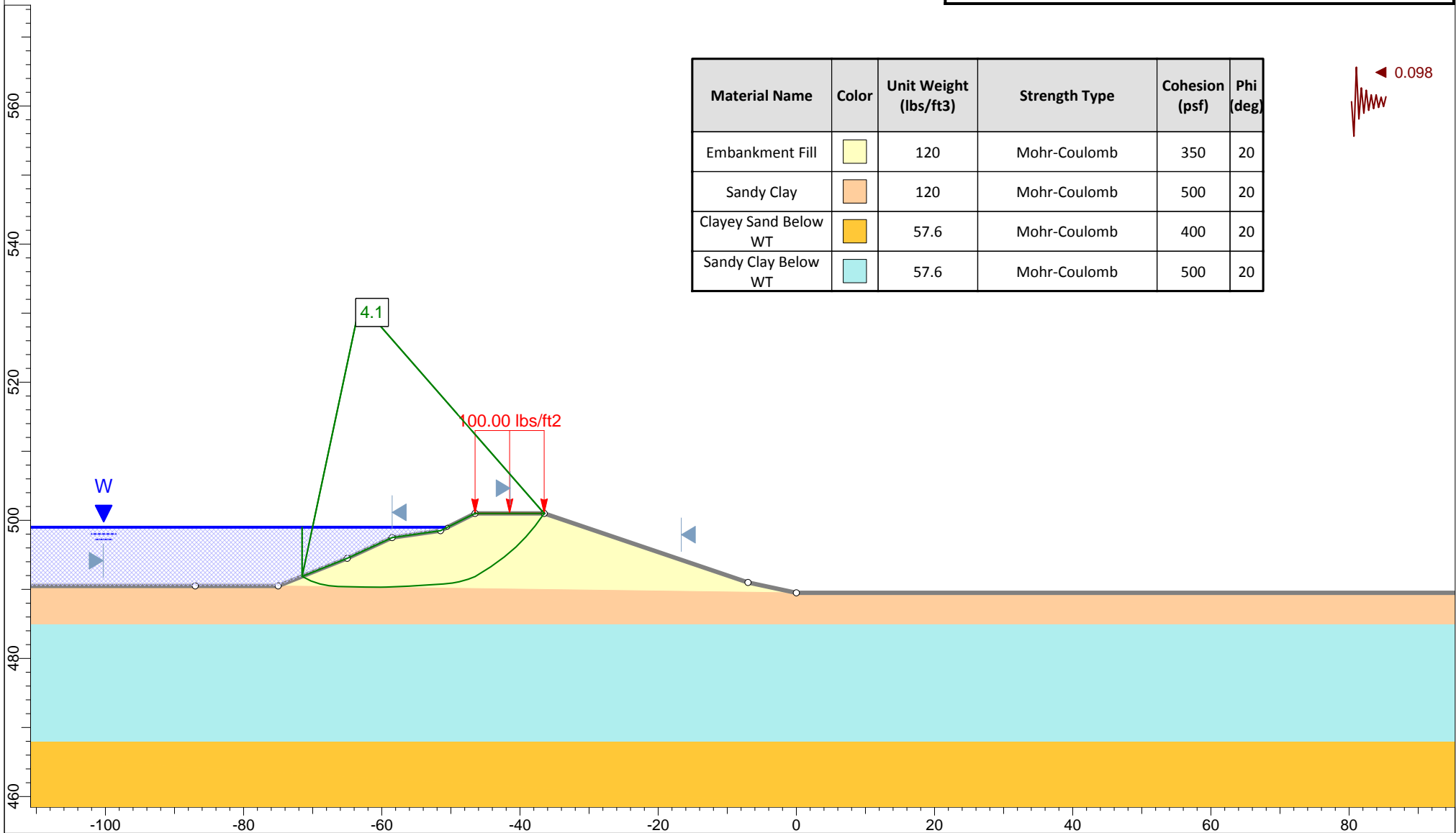

Profile "I" - Steady State
Ash Pond Berms - Spruce/Deely Generation Units

Raba Kistner Consultants, Inc.
ASA12-098-00

Figure D-22b



Global Stability Analysis

Material Name	Color	Unit Weight (lbs/ft ³)	Strength Type	Cohesion (psf)	Phi (deg)
Embankment Fill	Yellow	120	Mohr-Coulomb	350	20
Clayey Sand	Green	120	Mohr-Coulomb	400	20
Clayey Sand Below WT	Orange	57.6	Mohr-Coulomb	400	20

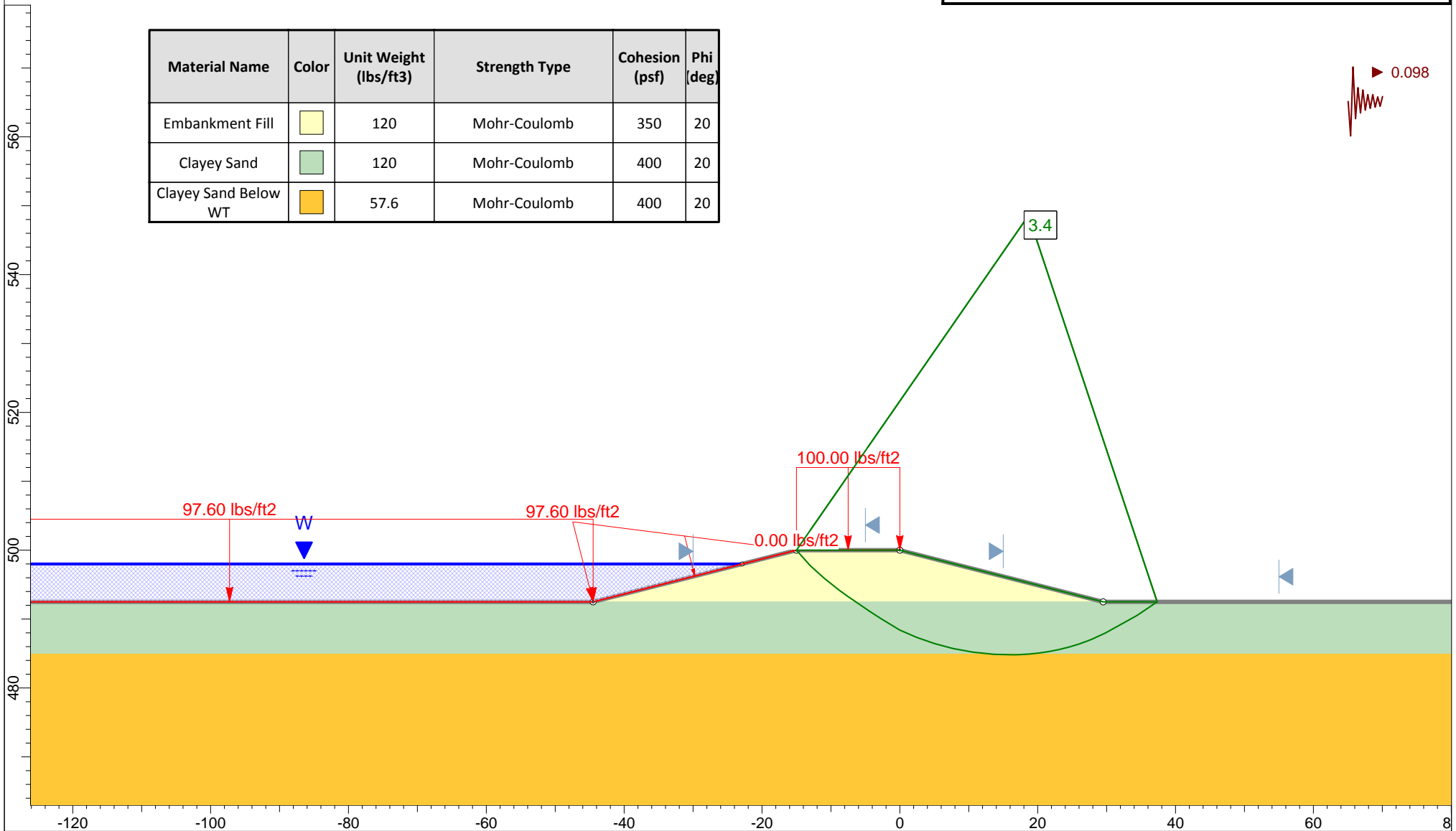



Profile "J" - Steady State
Ash Pond Berms - Spruce/Deely Generation Units

Raba Kistner Consultants, Inc.
ASA12-098-00

Figure D-23a



Global Stability Analysis

Material Name	Color	Unit Weight (lbs/ft ³)	Strength Type	Cohesion (psf)	Phi (deg)
Embankment Fill		120	Mohr-Coulomb	350	20
Clayey Sand		120	Mohr-Coulomb	400	20
Clayey Sand Below WT		57.6	Mohr-Coulomb	400	20

 0.098

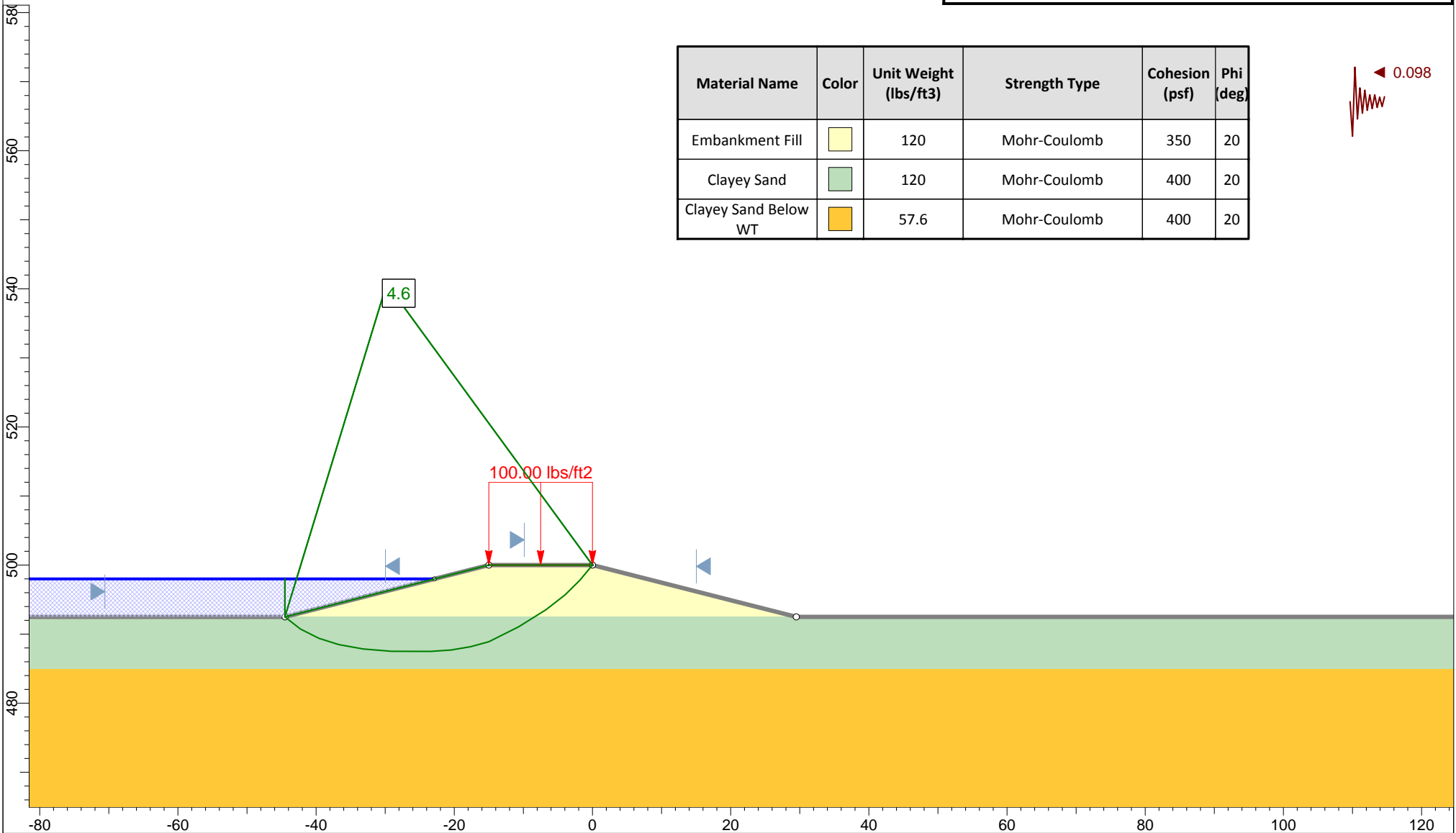



Profile "J" - Steady State
Ash Pond Berms - Spruce/Deely Generation Units

Raba Kistner Consultants, Inc.
ASA12-098-00

Figure D-23b



Global Stability Analysis

Material Name	Color	Unit Weight (lbs/ft ³)	Strength Type	Cohesion (psf)	Phi (deg)
Embankment Fill		120	Mohr-Coulomb	350	20
Sandy Clay		120	Mohr-Coulomb	500	20
Sandy Clay Below WT		57.6	Mohr-Coulomb	500	20

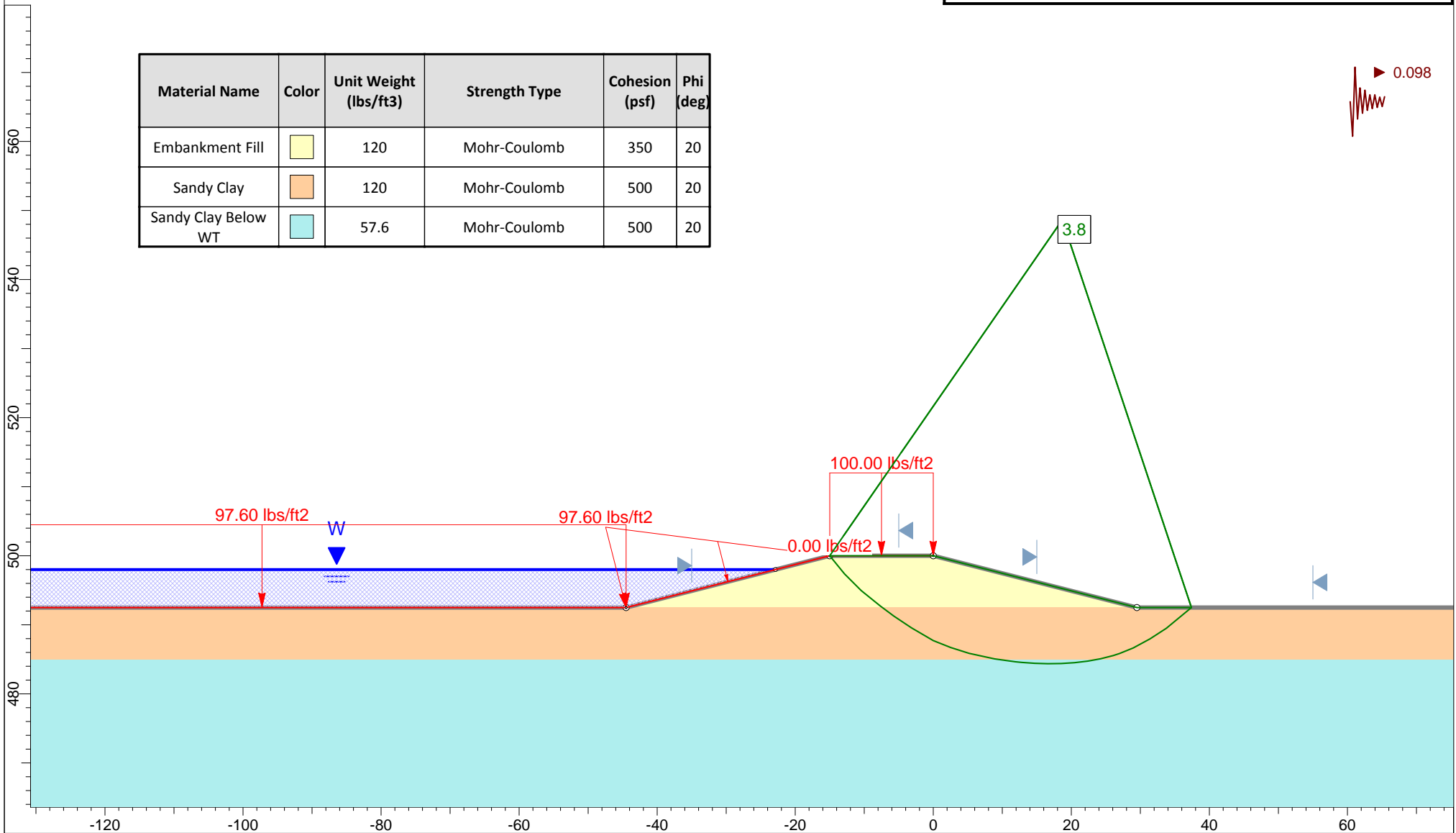

Profile "K" - Steady State
Ash Pond Berms - Spruce/Deely Generation Units

Raba Kistner Consultants, Inc.
ASA12-098-00

Figure D-24a



Global Stability Analysis

Material Name	Color	Unit Weight (lbs/ft ³)	Strength Type	Cohesion (psf)	Phi (deg)
Embankment Fill	Yellow	120	Mohr-Coulomb	350	20
Sandy Clay	Orange	120	Mohr-Coulomb	500	20
Sandy Clay Below WT	Light Blue	57.6	Mohr-Coulomb	500	20

◀ 0.098

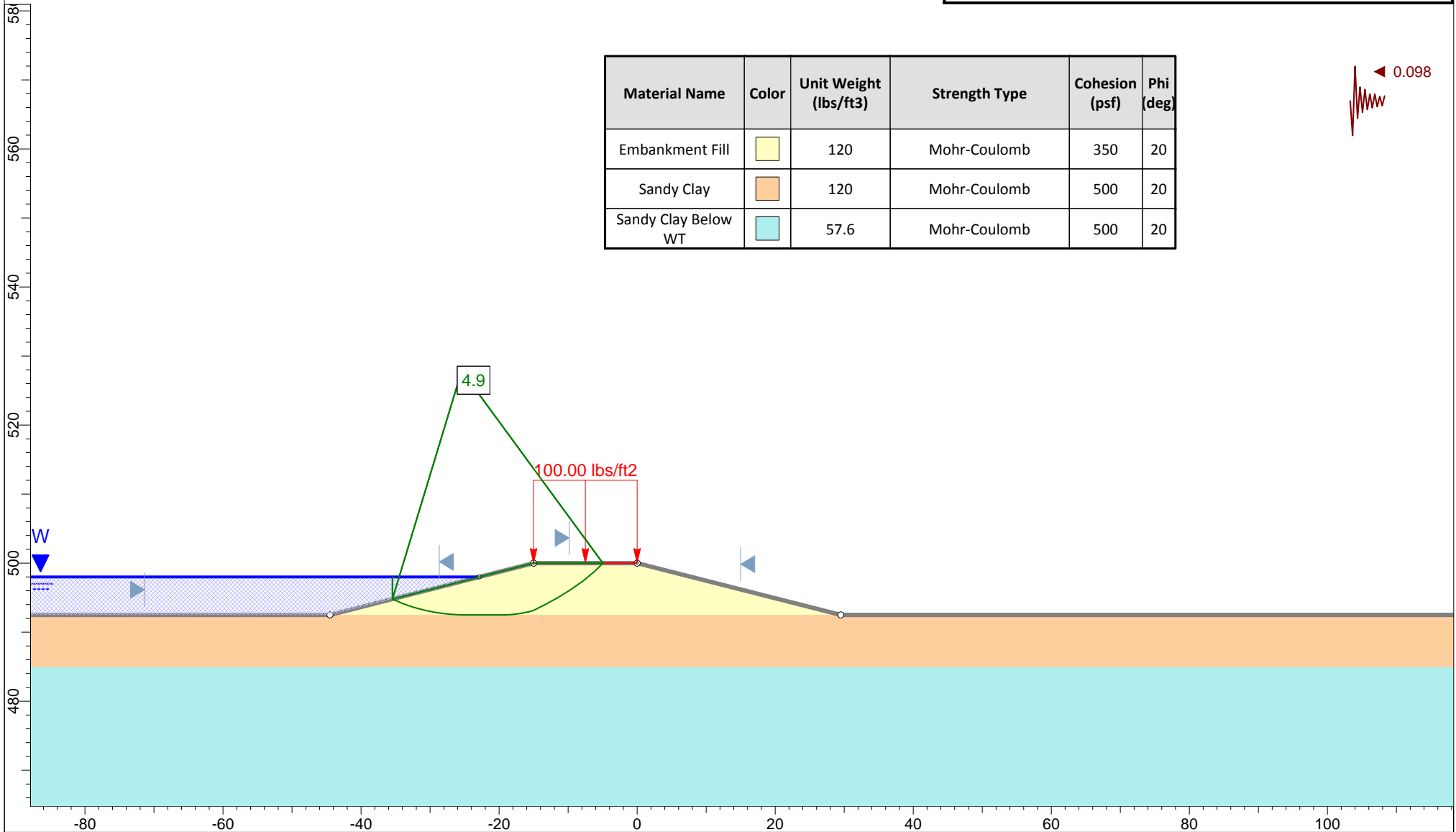





Profile "K" - Steady State
Ash Pond Berms - Spruce/Deely Generation Units

Raba Kistner Consultants, Inc.
ASA12-098-00

Figure D-24b



Global Stability Analysis

Material Name	Color	Unit Weight (lbs/ft ³)	Strength Type	Cohesion (psf)	Phi (deg)
Embankment Fill		120	Mohr-Coulomb	350	20
Clayey Sand		120	Mohr-Coulomb	400	20
Clayey Sand Below WT		57.6	Mohr-Coulomb	400	20
Sandy Clay Below WT		57.6	Mohr-Coulomb	500	20

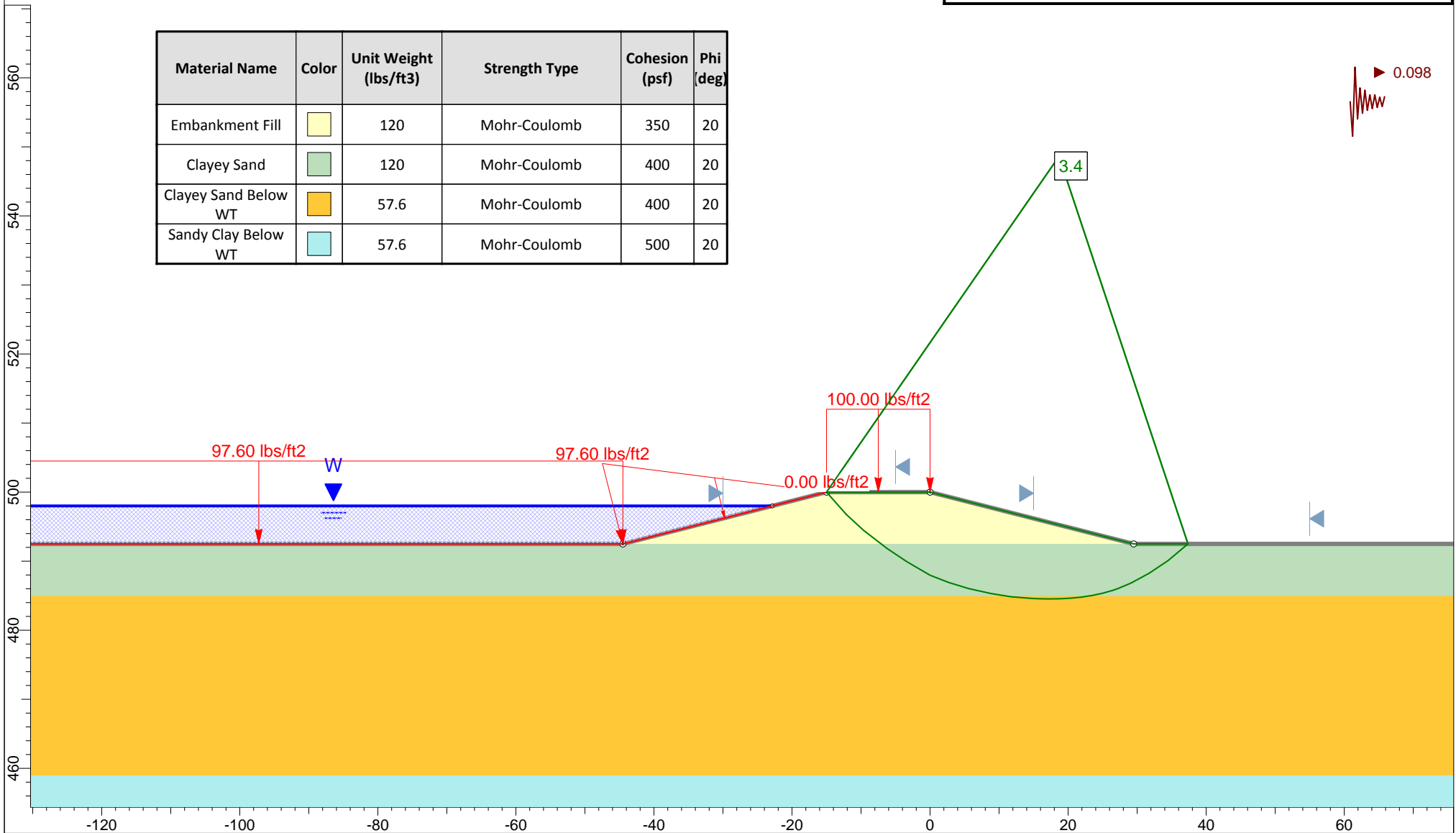

Profile "L" - Steady State
Ash Pond Berms - Spruce/Deely Generation Units





Raba Kistner Consultants, Inc.
ASA12-098-00

Figure D-25a

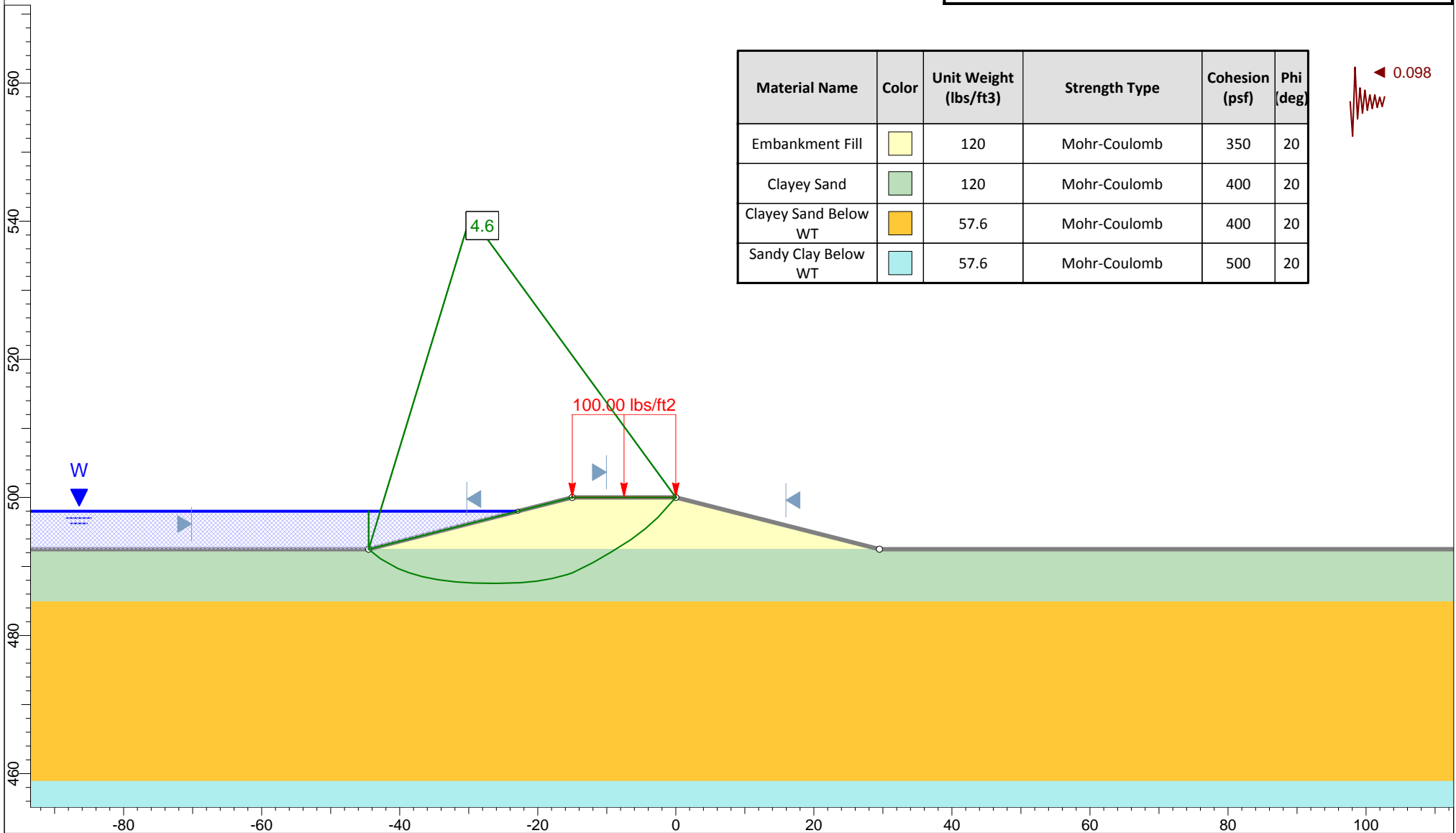

Global Stability Analysis



Material Name	Color	Unit Weight (lbs/ft3)	Strength Type	Cohesion (psf)	Phi (deg)
Embankment Fill		120	Mohr-Coulomb	350	20
Clayey Sand		120	Mohr-Coulomb	400	20
Clayey Sand Below WT		57.6	Mohr-Coulomb	400	20
Sandy Clay Below WT		57.6	Mohr-Coulomb	500	20

0.098





Profile "L" - Steady State
Ash Pond Berms - Spruce/Deely Generation Units

Raba Kistner Consultants, Inc.
ASA12-098-00

Figure D-25b



Global Stability Analysis

Material Name	Color	Unit Weight (lbs/ft ³)	Strength Type	Cohesion (psf)	Phi (deg)
Embankment Fill		120	Mohr-Coulomb	350	20
Sandy Clay		120	Mohr-Coulomb	500	20
Clayey Sand Below WT		57.6	Mohr-Coulomb	400	20
Sandy Clay Below WT		57.6	Mohr-Coulomb	500	20

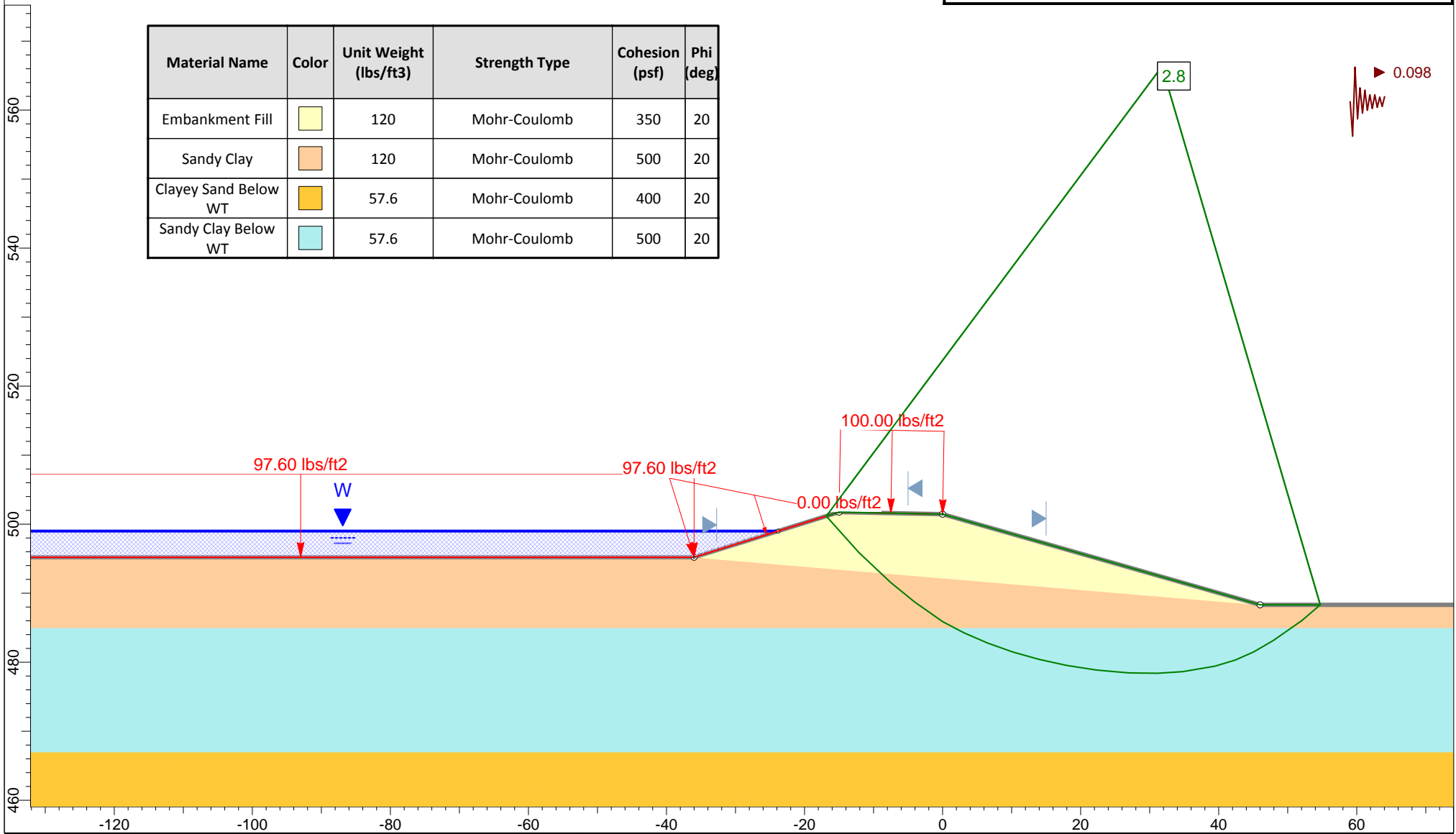





Profile "M" - Steady State
Ash Pond Berms - Spruce/Deely Generation Units

Raba Kistner Consultants, Inc.
ASA12-098-00

Figure D-26a



Global Stability Analysis

Material Name	Color	Unit Weight (lbs/ft ³)	Strength Type	Cohesion (psf)	Phi (deg)
Embankment Fill		120	Mohr-Coulomb	350	20
Sandy Clay		120	Mohr-Coulomb	500	20
Clayey Sand Below WT		57.6	Mohr-Coulomb	400	20
Sandy Clay Below WT		57.6	Mohr-Coulomb	500	20

◀ 0.098

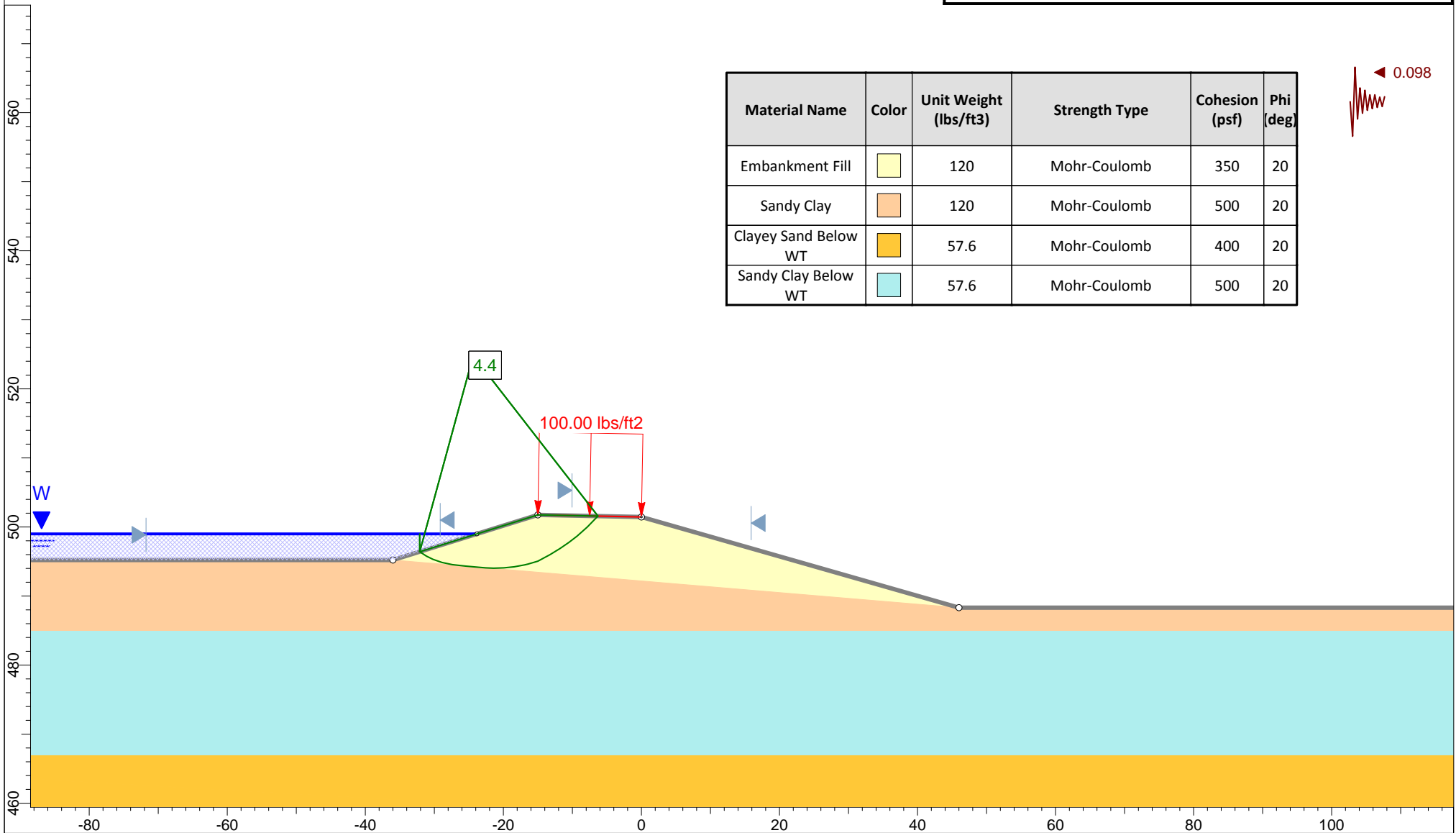

Profile "M" - Steady State
Ash Pond Berms - Spruce/Deely Generation Units

Raba Kistner Consultants, Inc.
ASA12-098-00

Figure D-26b



Global Stability Analysis

Material Name	Color	Unit Weight (lbs/ft ³)	Strength Type	Cohesion (psf)	Phi (deg)
Embankment Fill		120	Mohr-Coulomb	350	20
Clayey Sand		120	Mohr-Coulomb	400	20
Clayey Sand Below WT		57.6	Mohr-Coulomb	400	20

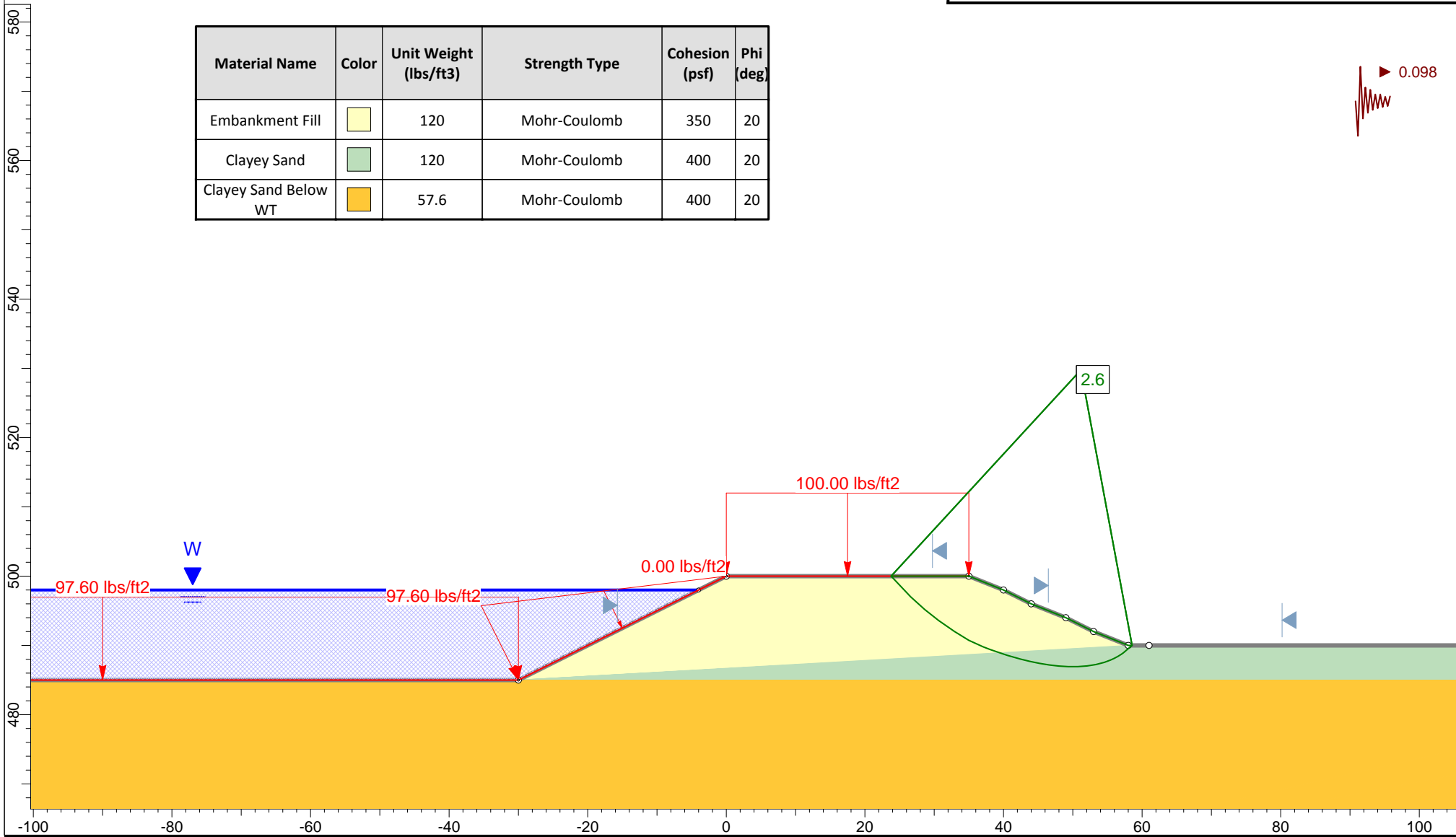

Profile "N" - Steady State
Ash Pond Berms - Spruce/Deely Generation Units

Raba Kistner Consultants, Inc.
ASA12-098-00

Figure D-27a



Global Stability Analysis

Material Name	Color	Unit Weight (lbs/ft ³)	Strength Type	Cohesion (psf)	Phi (deg)
Embankment Fill	Yellow	120	Mohr-Coulomb	350	20
Clayey Sand	Green	120	Mohr-Coulomb	400	20
Clayey Sand Below WT	Orange	57.6	Mohr-Coulomb	400	20

◀ 0.098

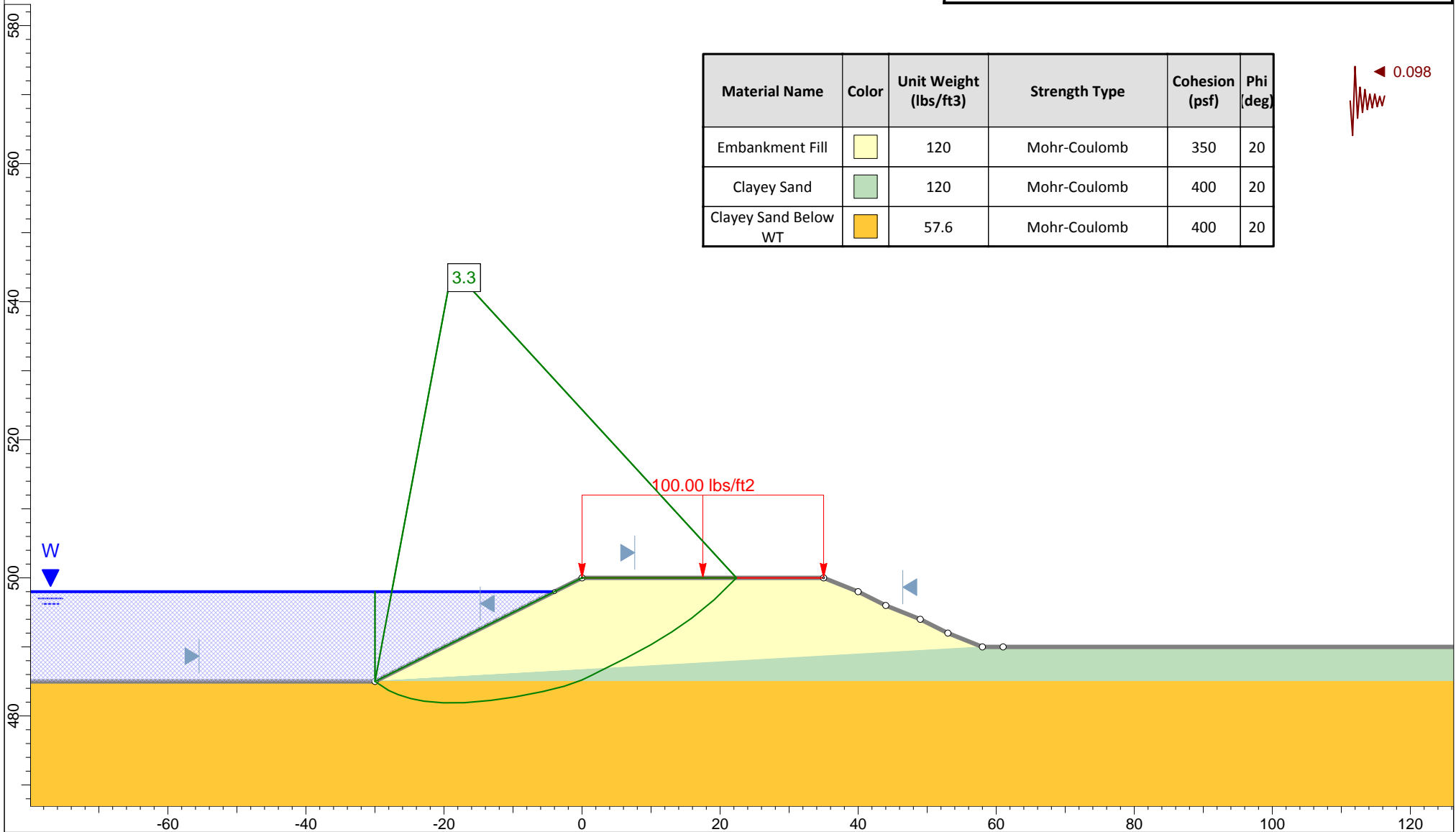



Profile "N" - Steady State
Ash Pond Berms - Spruce/Deely Generation Units

Raba Kistner Consultants, Inc.
ASA12-098-00

Figure D-27b



Global Stability Analysis

Material Name	Color	Unit Weight (lbs/ft ³)	Strength Type	Cohesion (psf)	Phi (deg)
Embankment Fill		120	Mohr-Coulomb	350	20
Clayey Sand		120	Mohr-Coulomb	400	20
Clayey Sand Below WT		57.6	Mohr-Coulomb	400	20

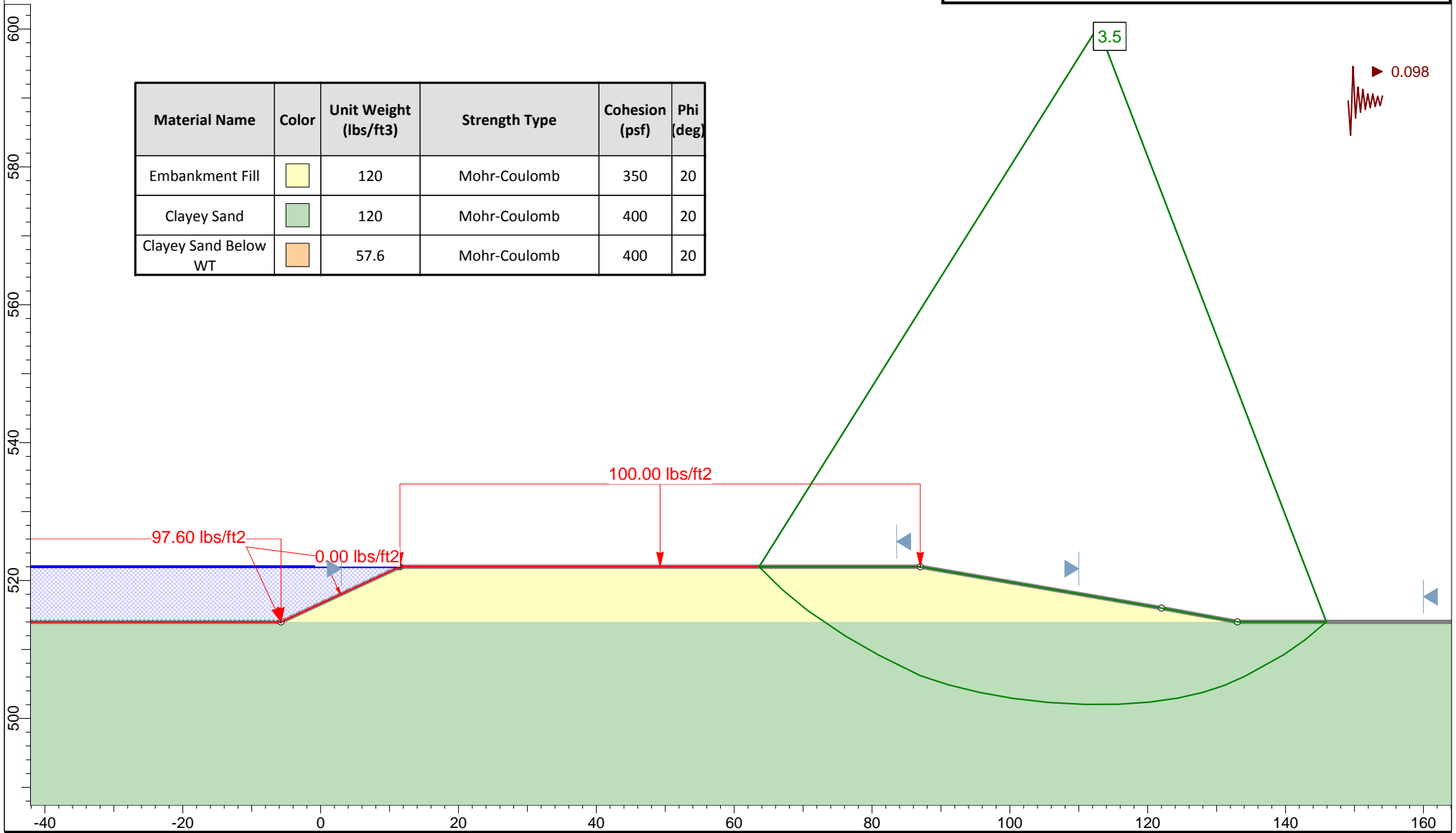

Profile "A" - Maximum Pool
Ash Pond Berms - Spruce/Deely Generation Units

Raba Kistner Consultants, Inc.
ASA12-098-00

Figure D-28a



Global Stability Analysis

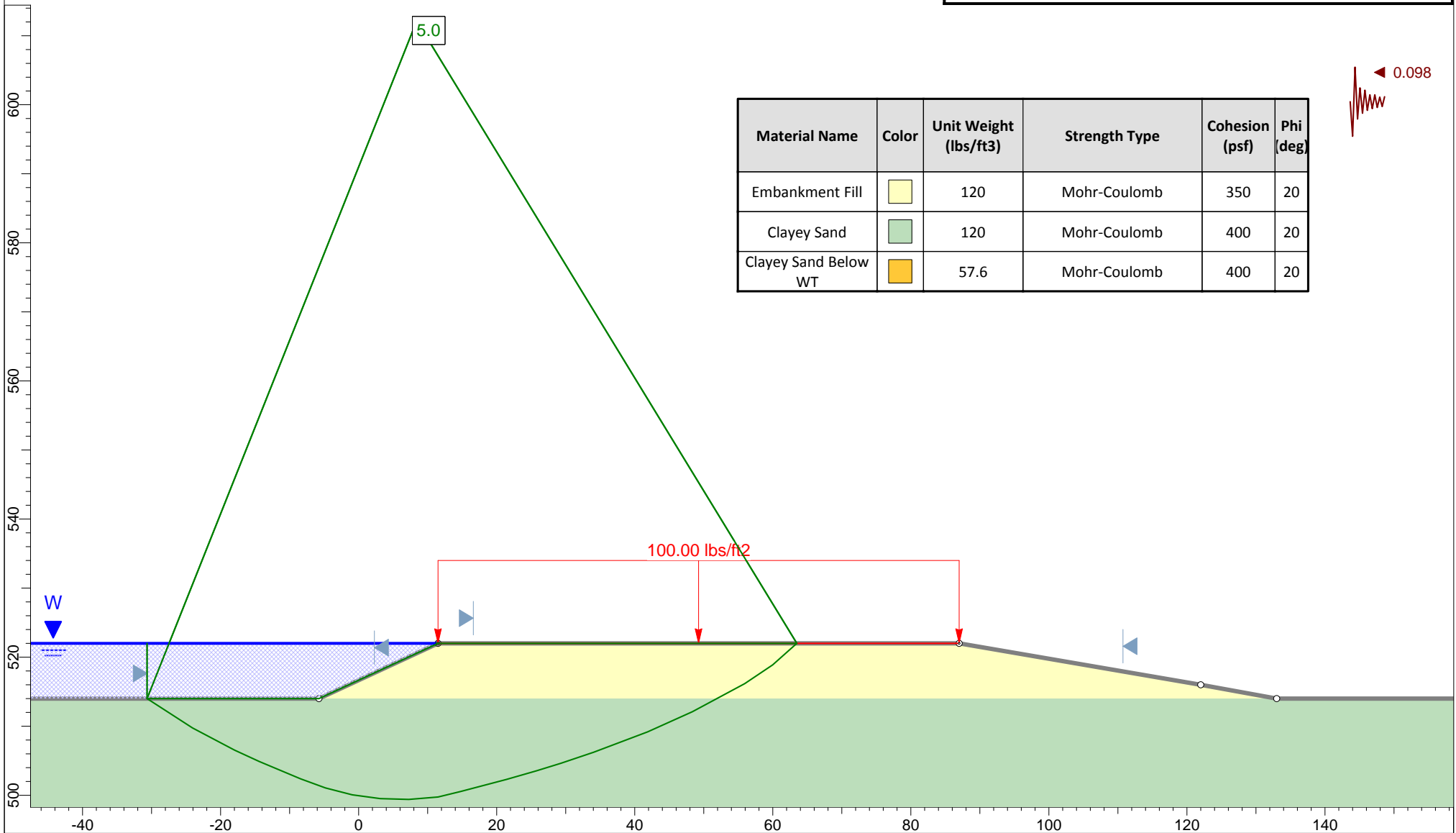

Material Name	Color	Unit Weight (lbs/ft ³)	Strength Type	Cohesion (psf)	Phi (deg)
Embankment Fill		120	Mohr-Coulomb	350	20
Clayey Sand		120	Mohr-Coulomb	400	20
Clayey Sand Below WT		57.6	Mohr-Coulomb	400	20





Profile "A" - Maximum Pool
Ash Pond Berms - Spruce/Deely Generation Units

Raba Kistner Consultants, Inc.
ASA12-098-00

Figure D-28b



Global Stability Analysis

Material Name	Color	Unit Weight (lbs/ft ³)	Strength Type	Cohesion (psf)	Phi (deg)
Embankment Fill		120	Mohr-Coulomb	350	20
Clayey Sand		120	Mohr-Coulomb	400	20
Sandy Clay		120	Mohr-Coulomb	500	20
Clayey Sand Below WT		57.6	Mohr-Coulomb	400	20

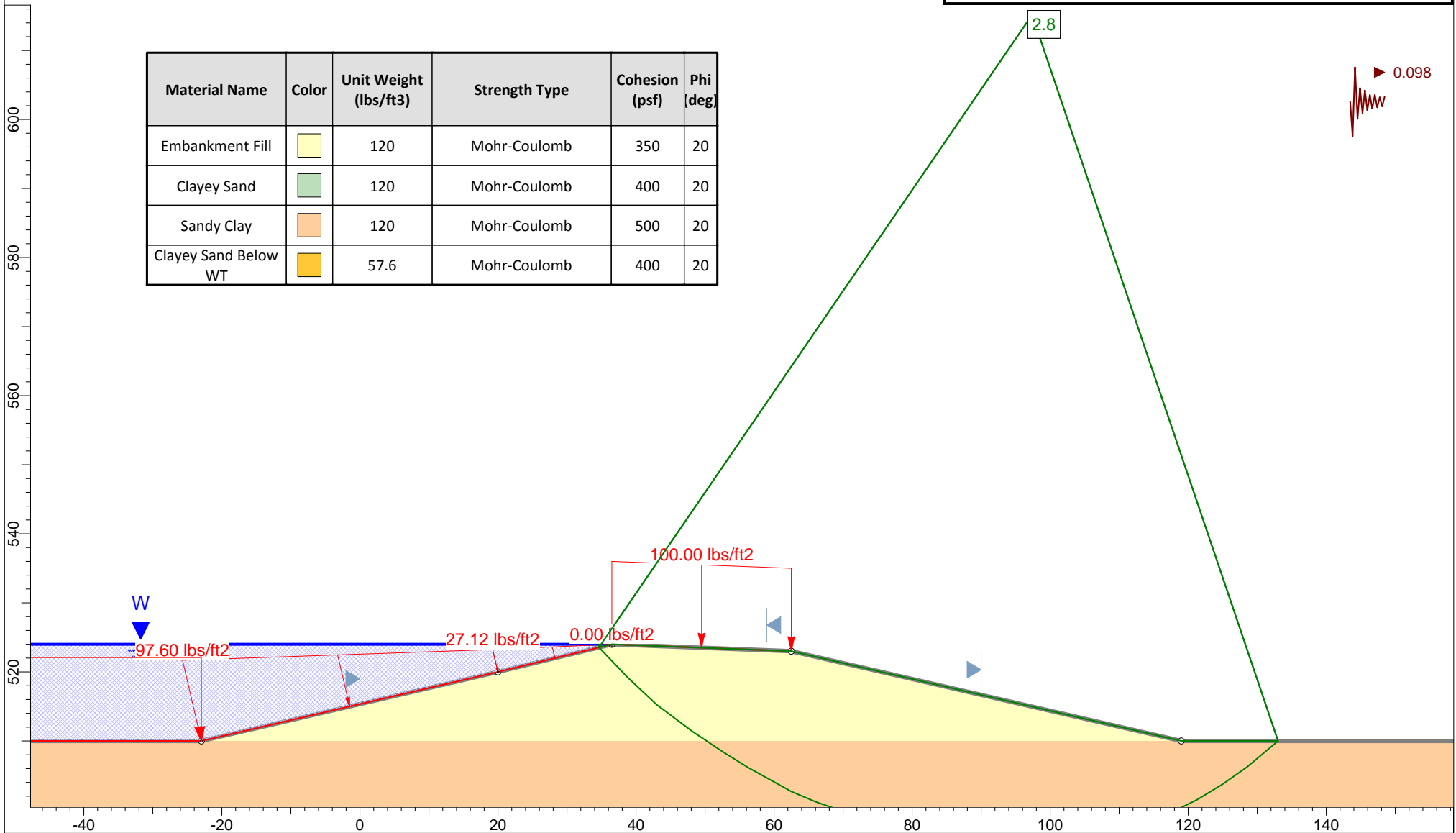

Profile "B" - Maximum Pool
Ash Pond Berms - Spruce/Deely Generation Units

Raba Kistner Consultants, Inc.
ASA12-098-00

Figure D-29a



Global Stability Analysis

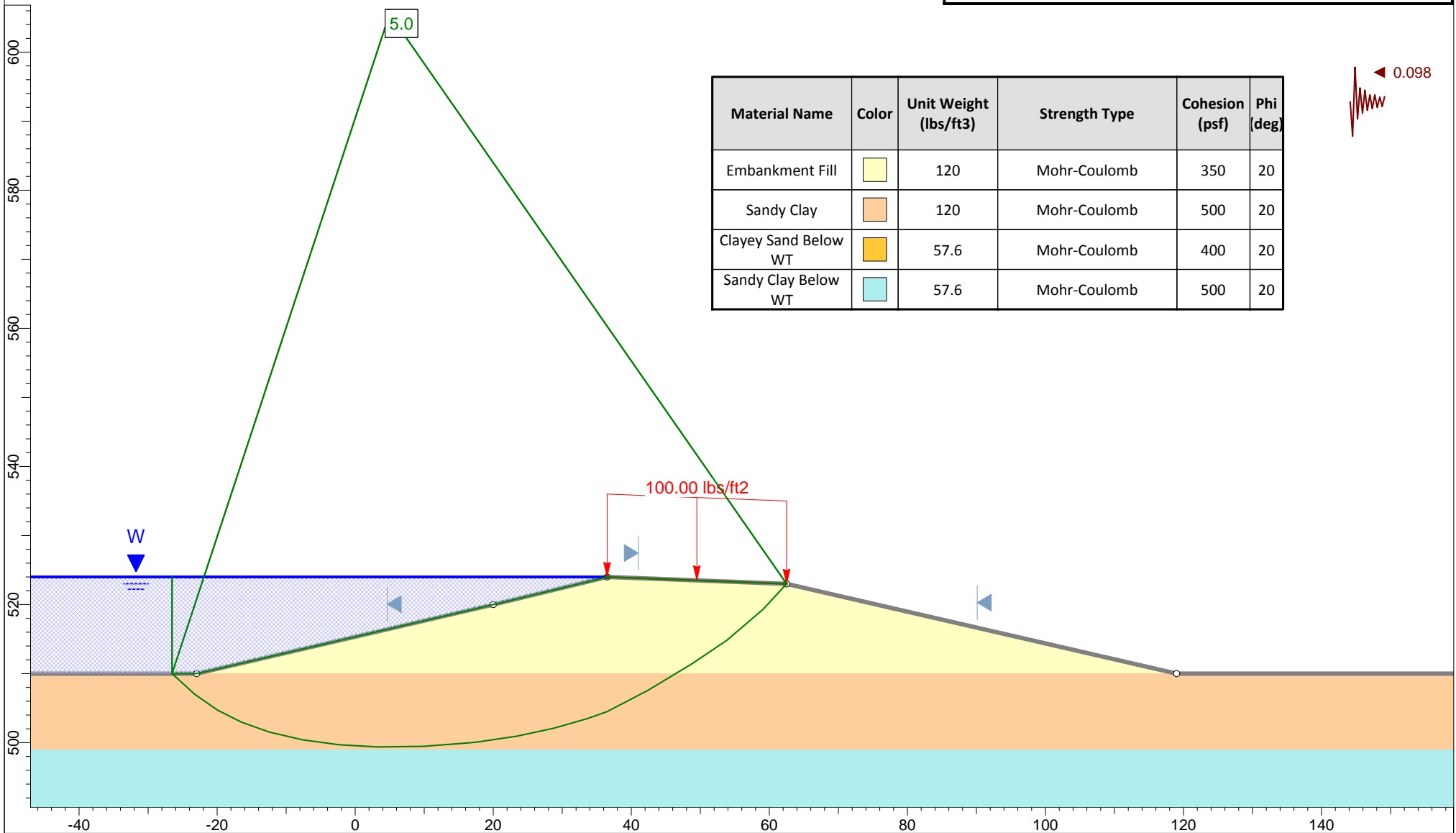



Profile "B" - Maximum Pool
Ash Pond Berms - Spruce/Deely Generation Units

Raba Kistner Consultants, Inc.
ASA12-098-00

Figure D-29b



Global Stability Analysis

Material Name	Color	Unit Weight (lbs/ft3)	Strength Type	Cohesion (psf)	Phi (deg)
Embankment Fill		120	Mohr-Coulomb	350	20
Clayey Sand		120	Mohr-Coulomb	400	20
Clayey Sand Below WT		57.6	Mohr-Coulomb	400	20

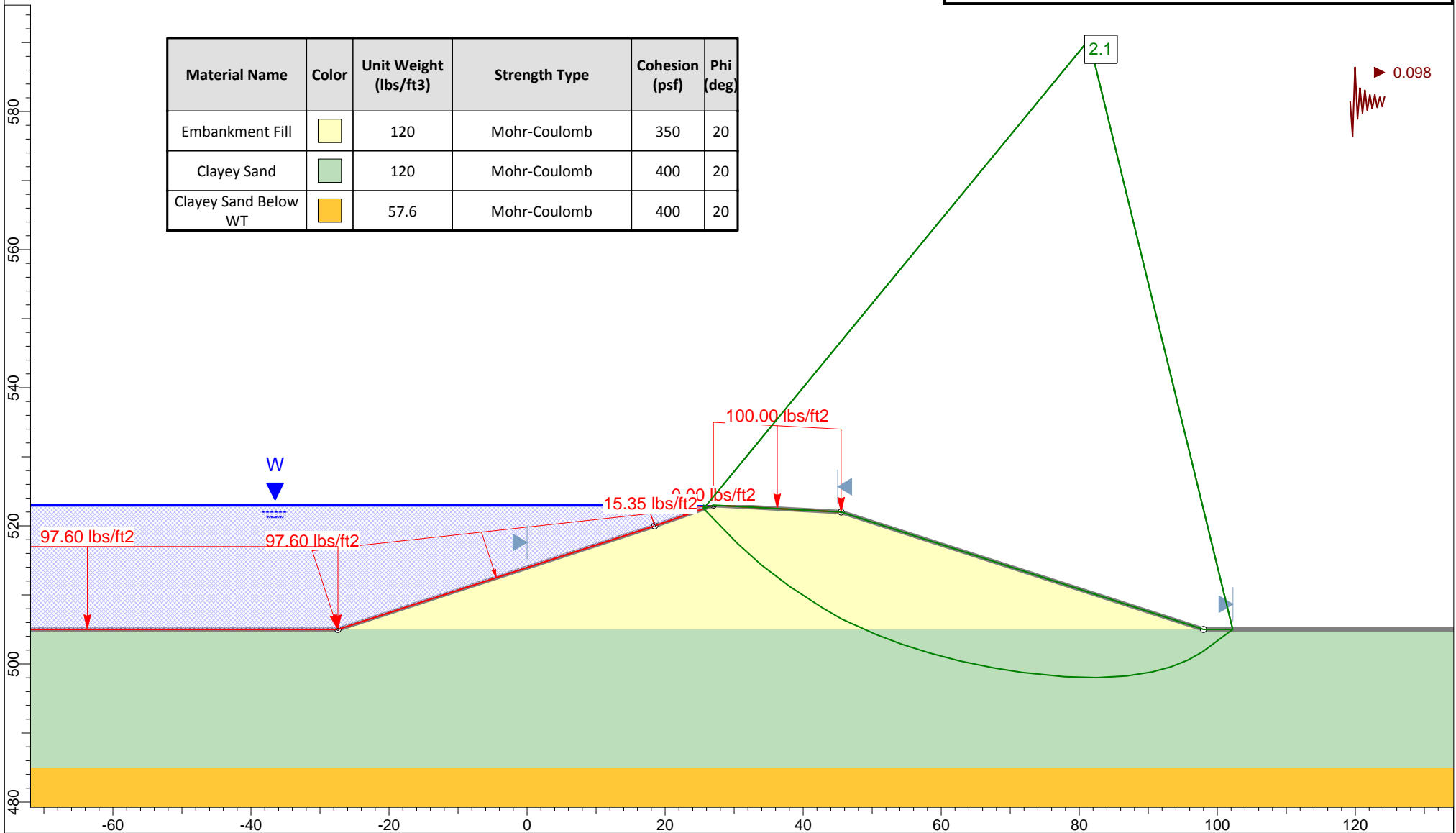

Profile "C" - Maximum Pool
Ash Pond Berms - Spruce/Deely Generation Units

Raba Kistner Consultants, Inc.
ASA12-098-00

Figure D-30a



Global Stability Analysis

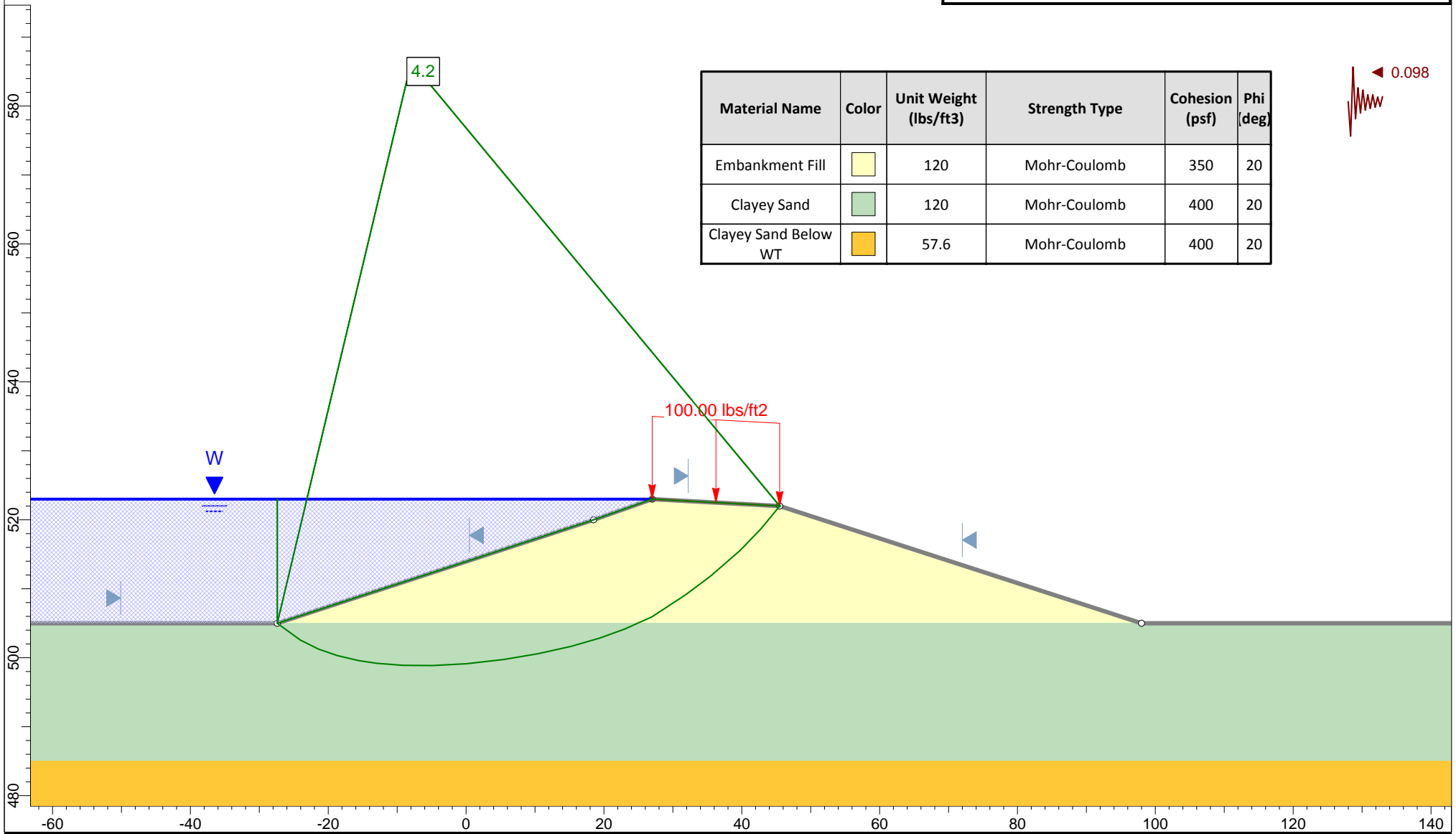

Material Name	Color	Unit Weight (lbs/ft ³)	Strength Type	Cohesion (psf)	Phi (deg)
Embankment Fill	Yellow	120	Mohr-Coulomb	350	20
Clayey Sand	Green	120	Mohr-Coulomb	400	20
Clayey Sand Below WT	Orange	57.6	Mohr-Coulomb	400	20





Profile "C" - Maximum Pool
Ash Pond Berms - Spruce/Deely Generation Units

Raba Kistner Consultants, Inc.
ASA12-098-00

Figure D-30b



Global Stability Analysis

Material Name	Color	Unit Weight (lbs/ft ³)	Strength Type	Cohesion (psf)	Phi (deg)
Embankment Fill		120	Mohr-Coulomb	350	20
Clayey Sand		120	Mohr-Coulomb	400	20
Sandy Clay		120	Mohr-Coulomb	500	20
Clayey Sand Below WT		57.6	Mohr-Coulomb	400	20

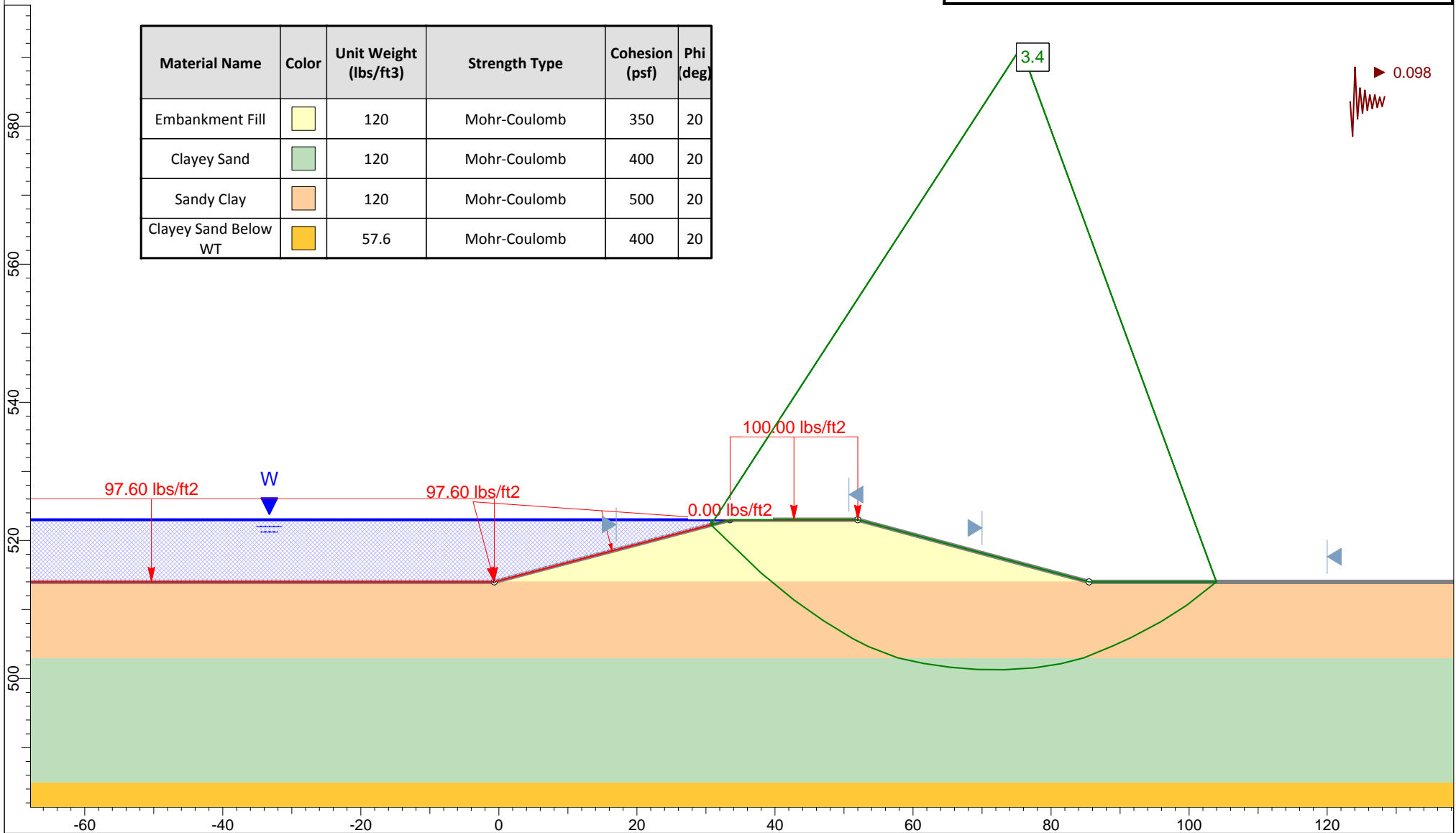

Profile "D" - Maximum Pool
Ash Pond Berms - Spruce/Deely Generation Units

Raba Kistner Consultants, Inc.
ASA12-098-00

Figure D-31a



Global Stability Analysis

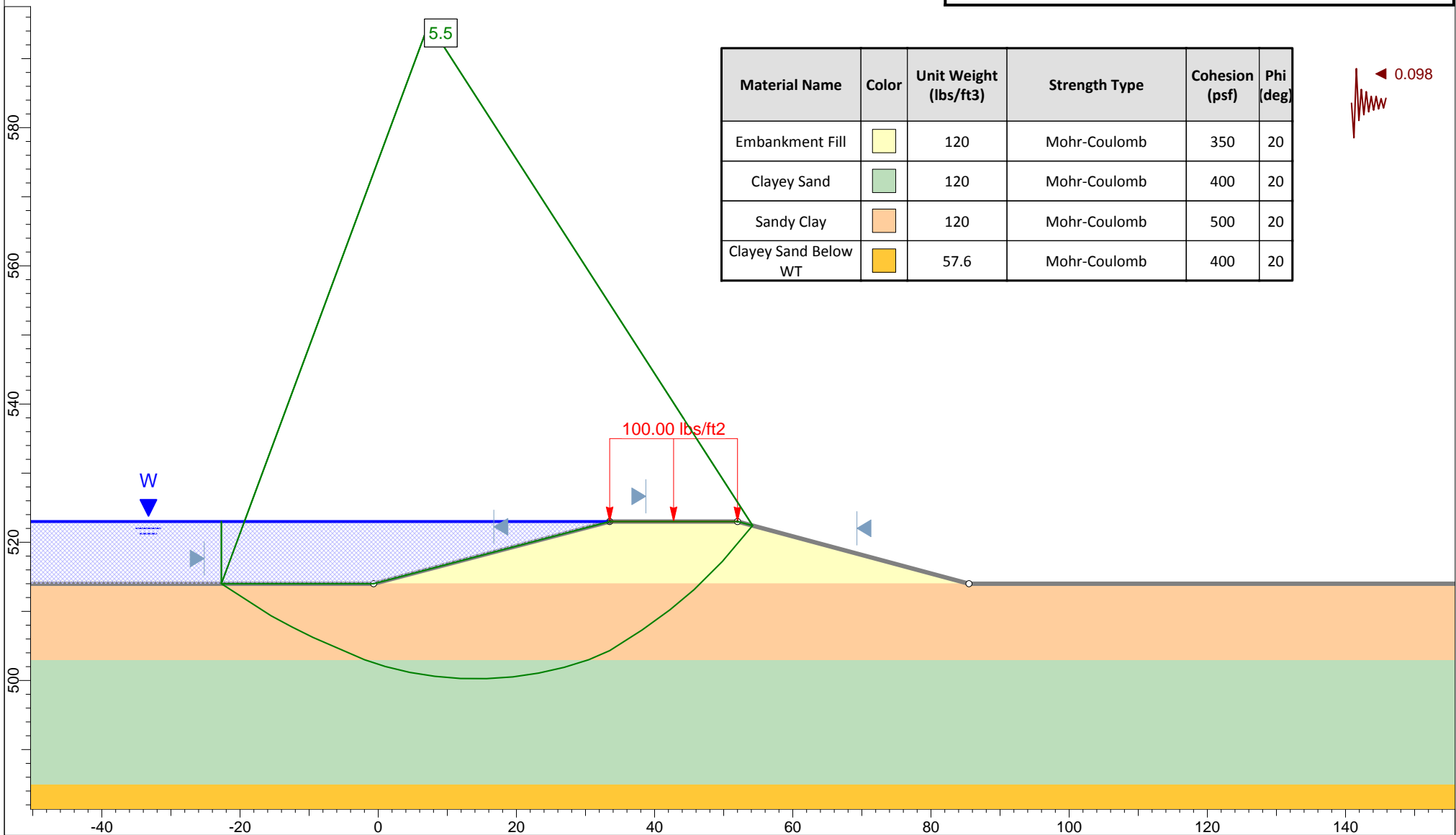

Material Name	Color	Unit Weight (lbs/ft3)	Strength Type	Cohesion (psf)	Phi (deg)
Embankment Fill	Yellow	120	Mohr-Coulomb	350	20
Clayey Sand	Green	120	Mohr-Coulomb	400	20
Sandy Clay	Orange	120	Mohr-Coulomb	500	20
Clayey Sand Below WT	Yellow-Orange	57.6	Mohr-Coulomb	400	20

0.098



Profile "D" - Maximum Pool
Ash Pond Berms - Spruce/Deely Generation Units

Raba Kistner Consultants, Inc.
ASA12-098-00

Figure D-31b



Global Stability Analysis

Material Name	Color	Unit Weight (lbs/ft ³)	Strength Type	Cohesion (psf)	Phi (deg)
Embankment Soil		120	Mohr-Coulomb	350	20
Sandy Clay		120	Mohr-Coulomb	500	20
Clayey Sand Below WT		57.6	Mohr-Coulomb	400	20

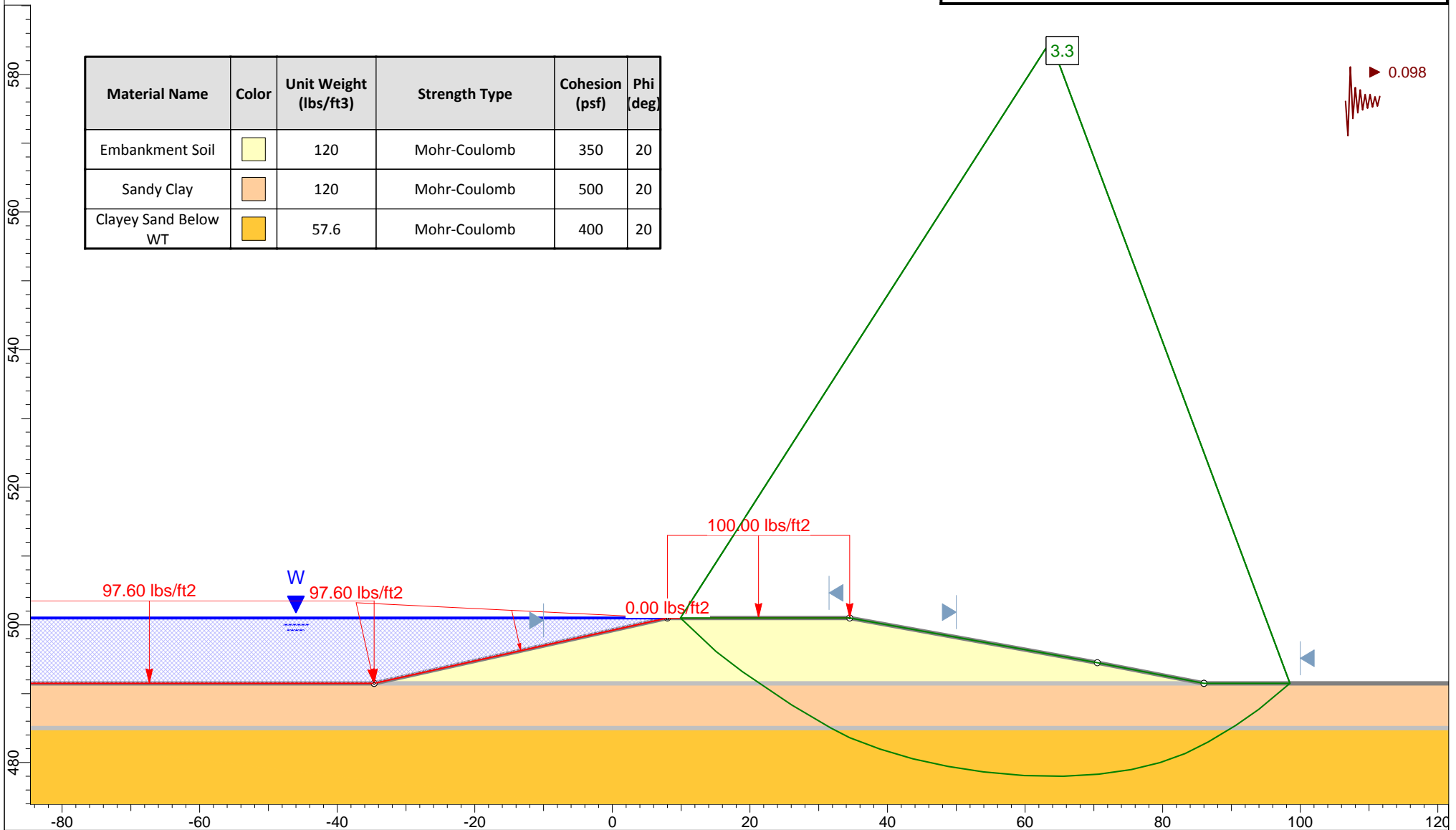

Profile "E" - Maximum Pool
Ash Pond Berms - Spruce/Deely Generation Units

Raba Kistner Consultants, Inc.
ASA12-098-00

Figure D-32a



Global Stability Analysis

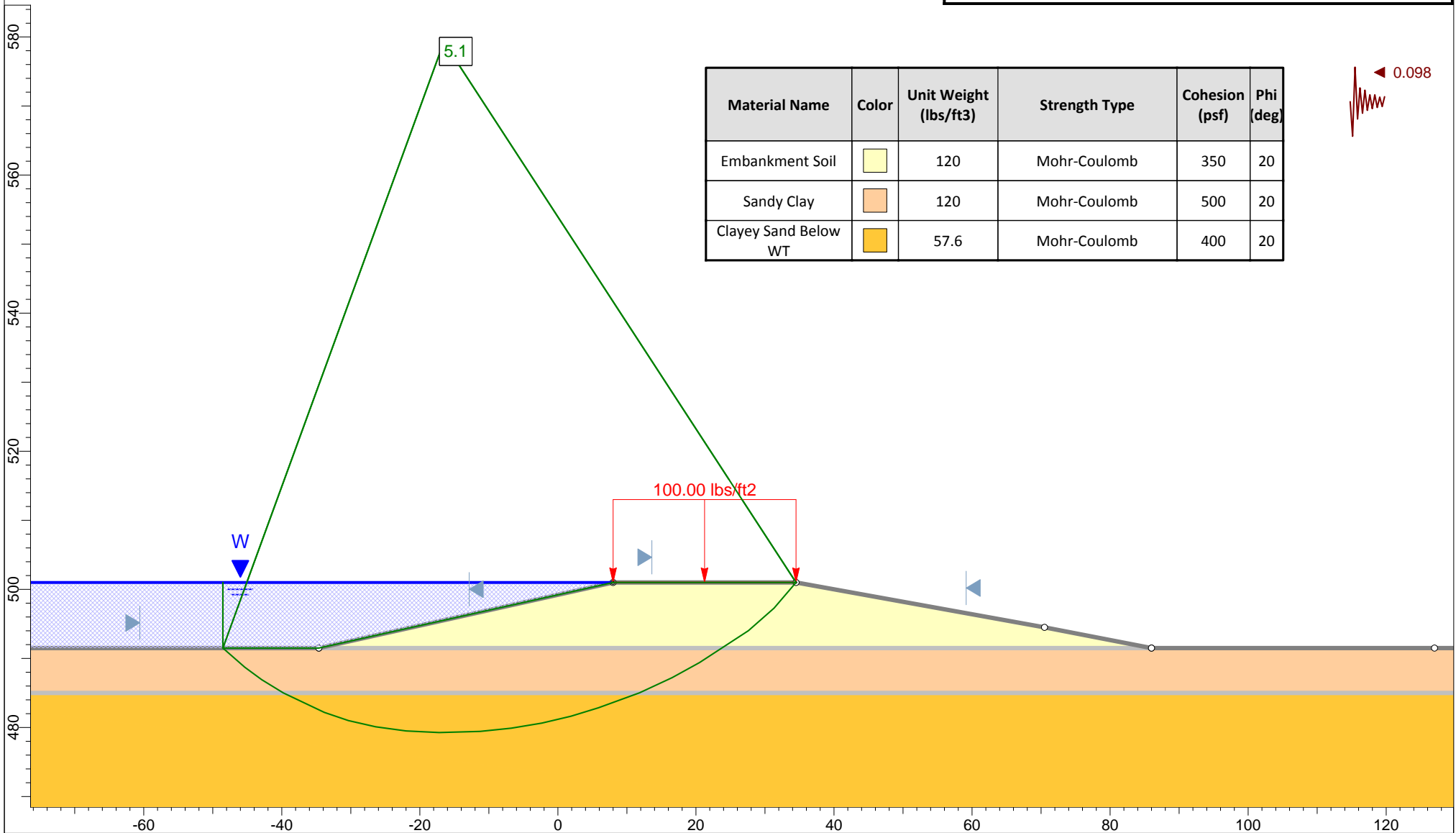





Profile "E" - Maximum Pool
Ash Pond Berms - Spruce/Deely Generation Units

Raba Kistner Consultants, Inc.
ASA12-098-00

Figure D-32b



Global Stability Analysis

Material Name	Color	Unit Weight (lbs/ft ³)	Strength Type	Cohesion (psf)	Phi (deg)
Embankment Fill		120	Mohr-Coulomb	350	20
Clayey Sand		120	Mohr-Coulomb	400	20
Clayey Sand Below WT		57.6	Mohr-Coulomb	400	20
Sandy Clay Below WT		57.6	Mohr-Coulomb	500	20

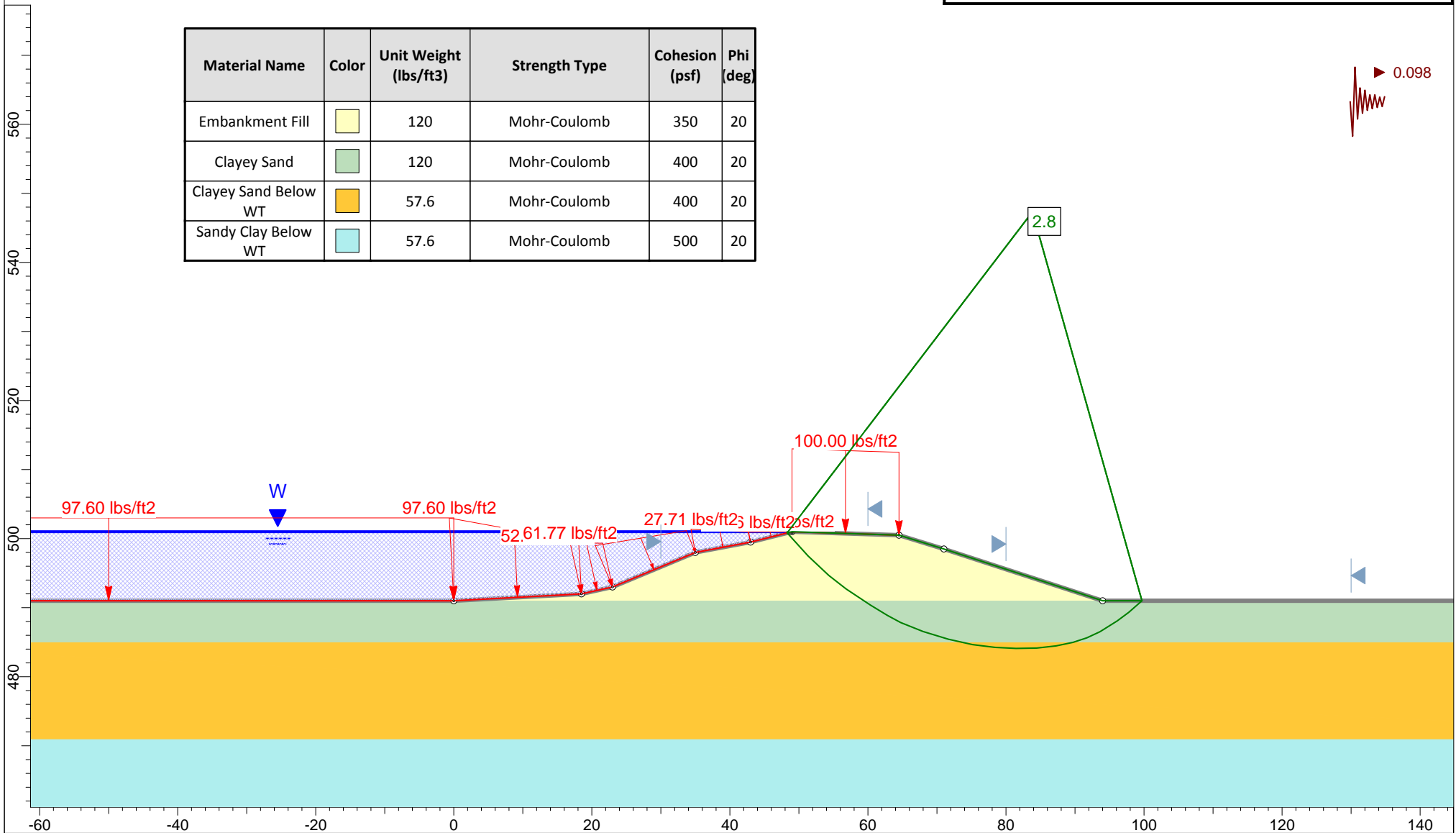





Profile "F" - Maximum Pool
Ash Pond Berms - Spruce/Deely Generation Units

Raba Kistner Consultants, Inc.
ASA12-098-00

Figure D-33a



Global Stability Analysis

Material Name	Color	Unit Weight (lbs/ft ³)	Strength Type	Cohesion (psf)	Phi (deg)
Embankment Fill		120	Mohr-Coulomb	350	20
Clayey Sand		120	Mohr-Coulomb	400	20
Clayey Sand Below WT		57.6	Mohr-Coulomb	400	20
Sandy Clay Below WT		57.6	Mohr-Coulomb	500	20

◀ 0.098

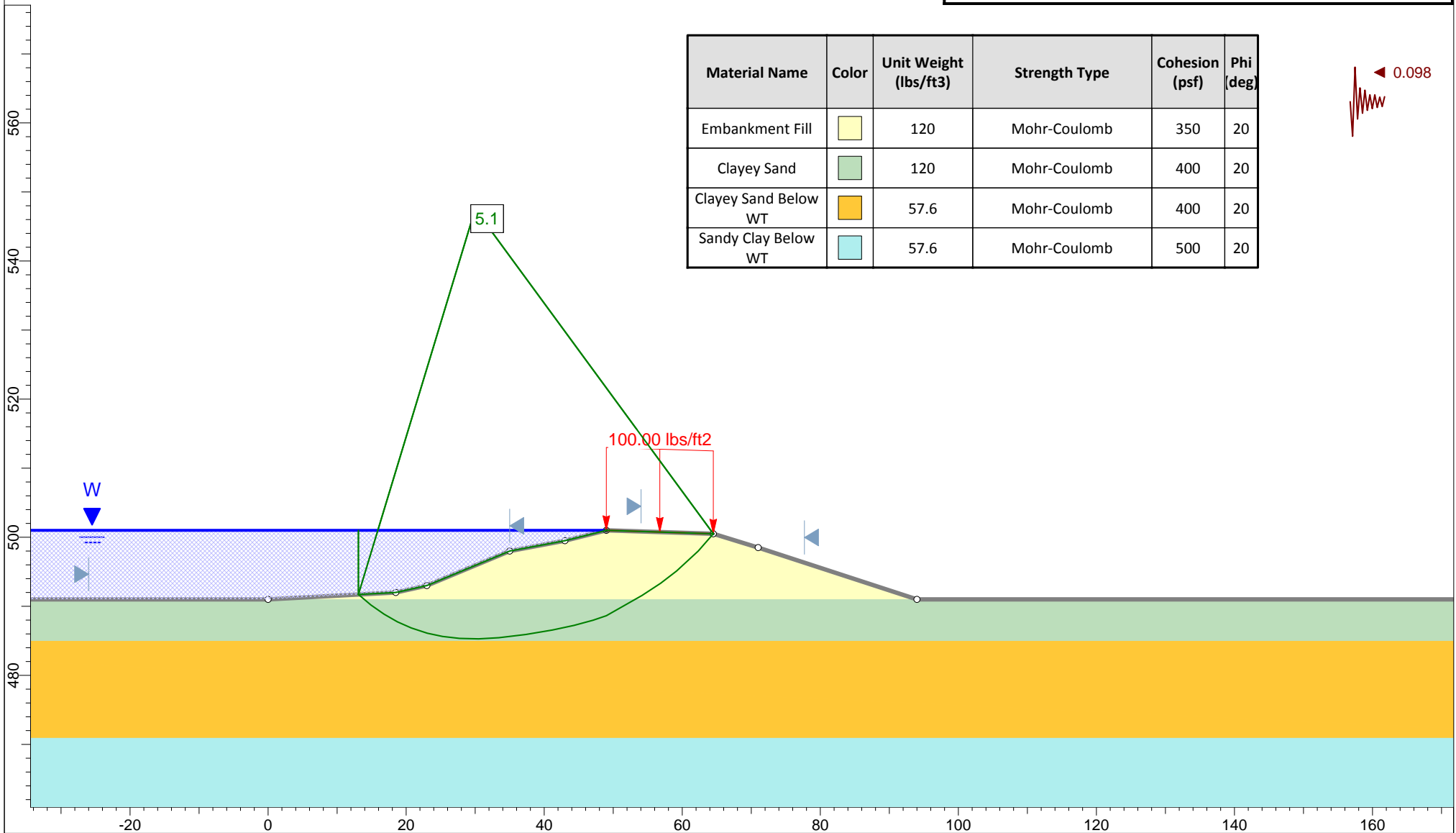

Profile "F" - Maximum Pool
Ash Pond Berms - Spruce/Deely Generation Units

Raba Kistner Consultants, Inc.
ASA12-098-00

Figure D-33b



Global Stability Analysis

Material Name	Color	Unit Weight (lbs/ft ³)	Strength Type	Cohesion (psf)	Phi (deg)
Embankment Fill		120	Mohr-Coulomb	350	20
Clayey Sand Below WT		57.6	Mohr-Coulomb	400	20
Sandy Clay Below WT		57.6	Mohr-Coulomb	500	20

 0.098

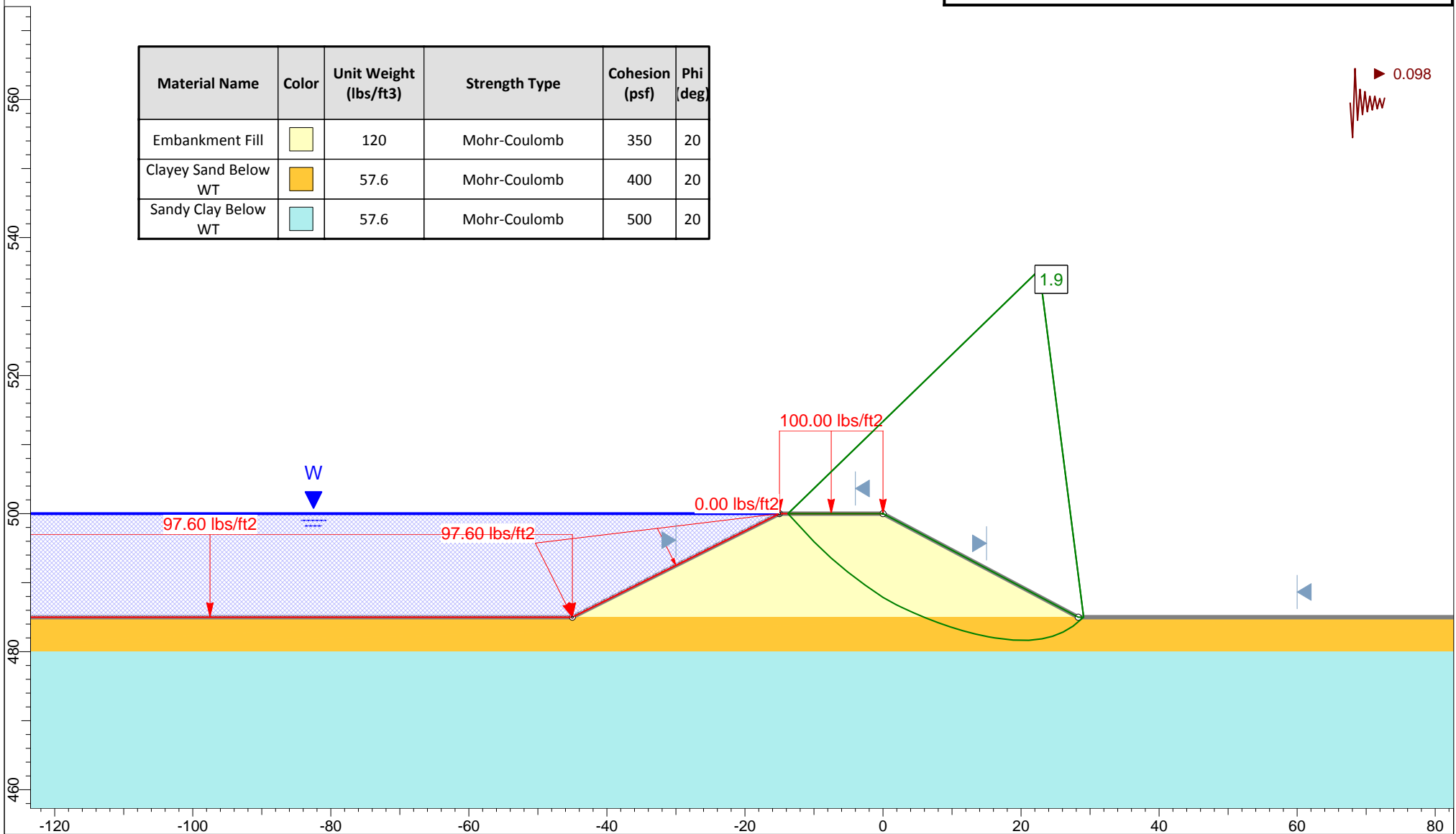

Profile "G" - Maximum Pool
Ash Pond Berms - Spruce/Deely Generation Units

Raba Kistner Consultants, Inc.
ASA12-098-00

Figure D-34a



Global Stability Analysis

Material Name	Color	Unit Weight (lbs/ft ³)	Strength Type	Cohesion (psf)	Phi (deg)
Embankment Fill	Yellow	120	Mohr-Coulomb	350	20
Clayey Sand Below WT	Orange	57.6	Mohr-Coulomb	400	20
Sandy Clay Below WT	Light Blue	57.6	Mohr-Coulomb	500	20

◀ 0.098

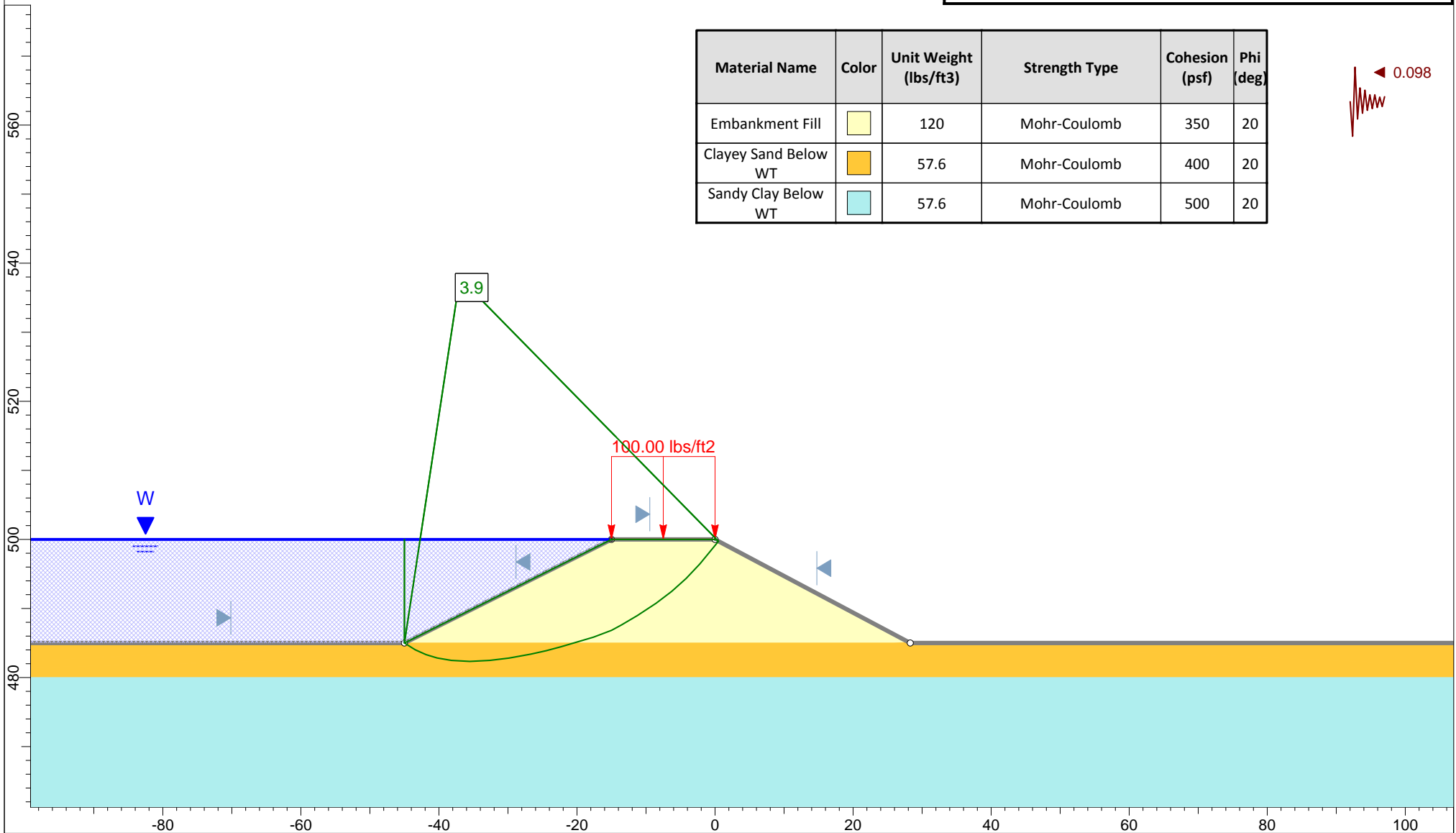





Profile "G" - Maximum Pool
Ash Pond Berms - Spruce/Deely Generation Units

Raba Kistner Consultants, Inc.
ASA12-098-00

Figure D-34b



Global Stability Analysis

Material Name	Color	Unit Weight (lbs/ft ³)	Strength Type	Cohesion (psf)	Phi (deg)
Embankment Fill		120	Mohr-Coulomb	350	20
Sandy Clay		120	Mohr-Coulomb	500	20
Clayey Sand Below WT		57.6	Mohr-Coulomb	400	20
Sandy Clay Below WT		57.6	Mohr-Coulomb	500	20

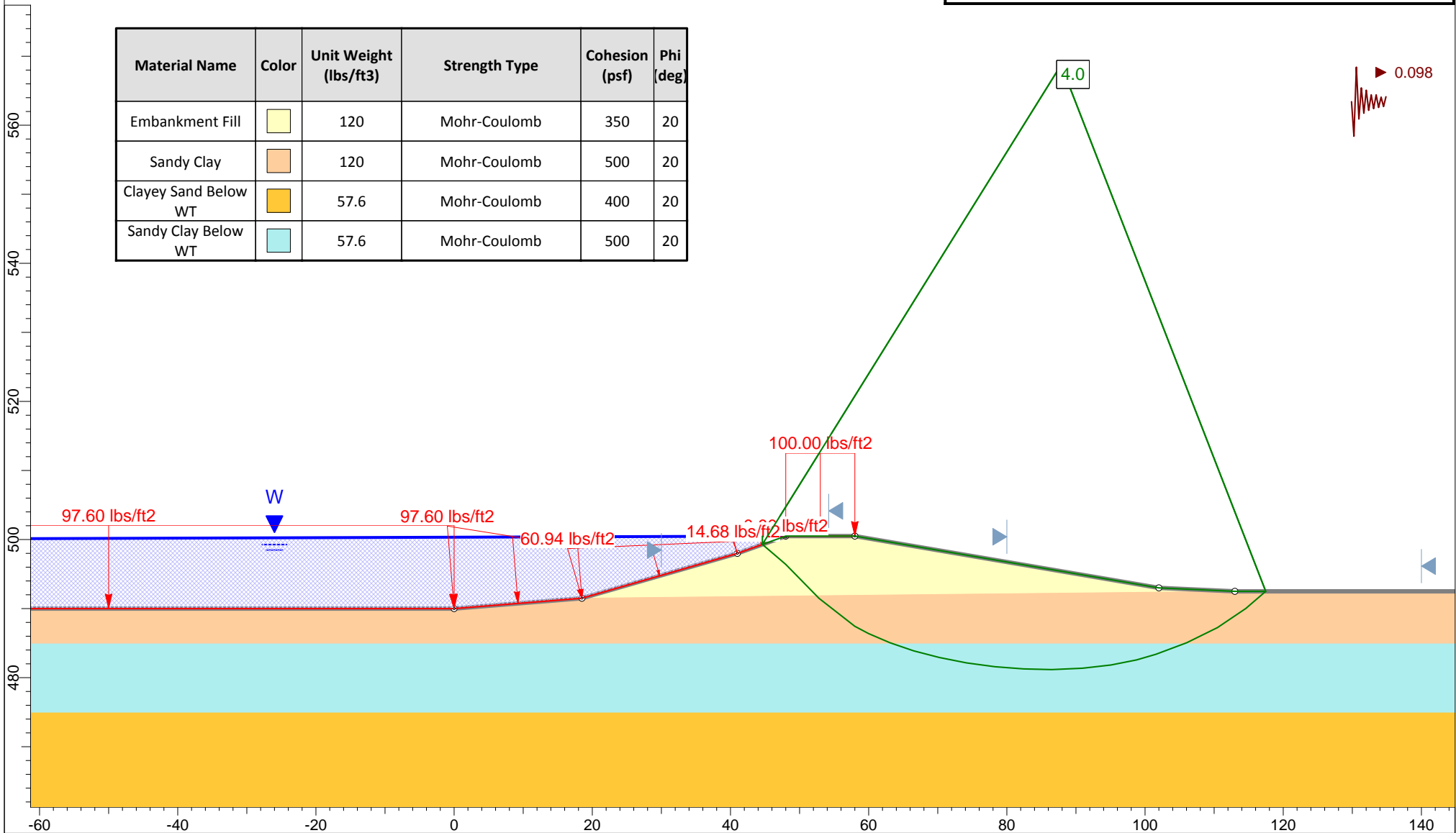





Profile "H" - Maximum Pool
Ash Pond Berms - Spruce/Deely Generation Units

Raba Kistner Consultants, Inc.
ASA12-098-00

Figure D-35a



Global Stability Analysis

Material Name	Color	Unit Weight (lbs/ft ³)	Strength Type	Cohesion (psf)	Phi (deg)
Embankment Fill		120	Mohr-Coulomb	350	20
Sandy Clay		120	Mohr-Coulomb	500	20
Clayey Sand Below WT		57.6	Mohr-Coulomb	400	20
Sandy Clay Below WT		57.6	Mohr-Coulomb	500	20

 0.098

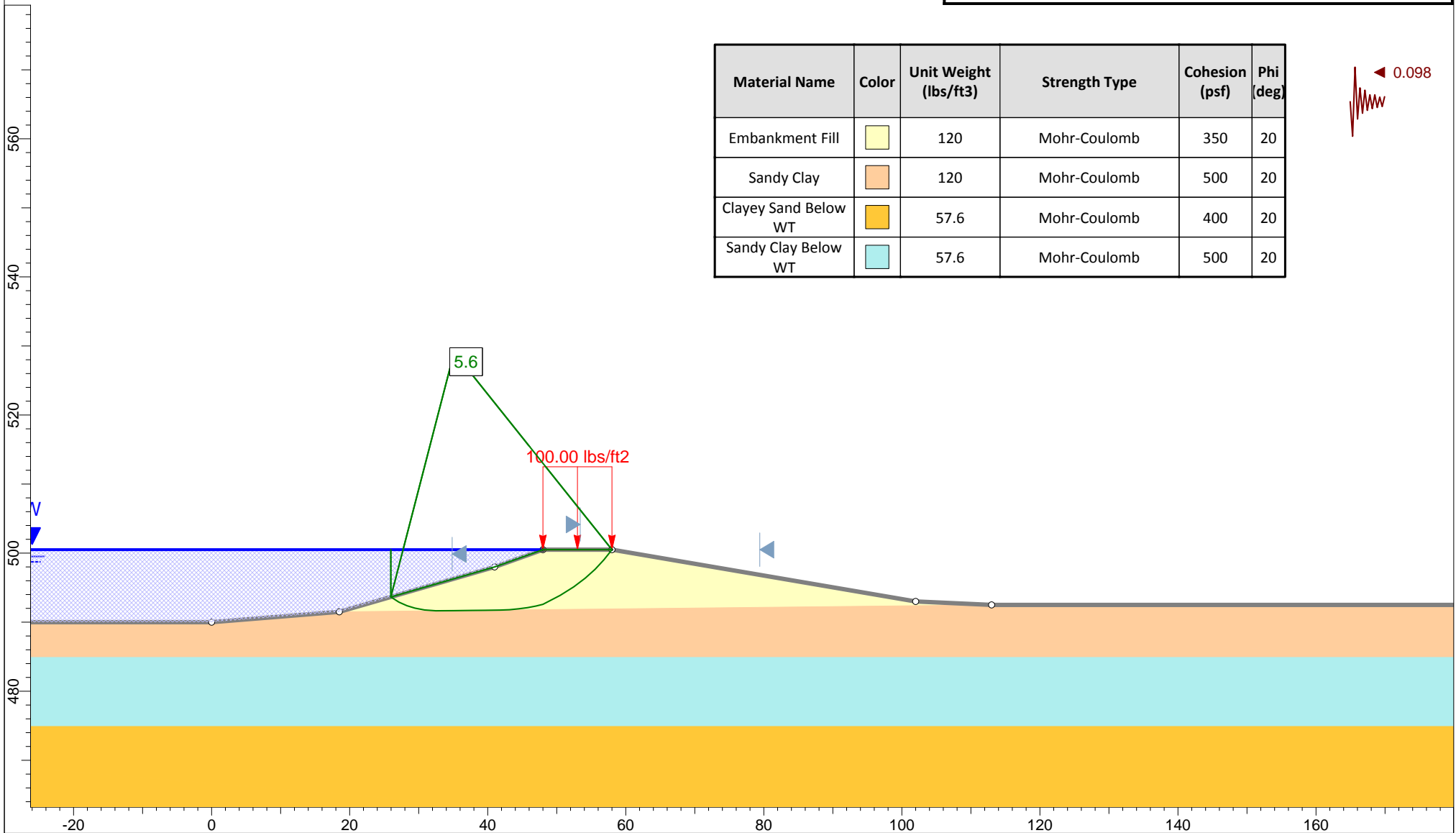





Profile "H" - Maximum Pool
Ash Pond Berms - Calaveras Lake Power Plant

Raba Kistner Consultants, Inc.
ASA12-098-00

Figure D-35b



Global Stability Analysis

Material Name	Color	Unit Weight (lbs/ft ³)	Strength Type	Cohesion (psf)	Phi (deg)
Embankment Fill		120	Mohr-Coulomb	350	20
Sandy Clay		120	Mohr-Coulomb	500	20
Clayey Sand Below WT		57.6	Mohr-Coulomb	400	20
Sandy Clay Below WT		57.6	Mohr-Coulomb	500	20

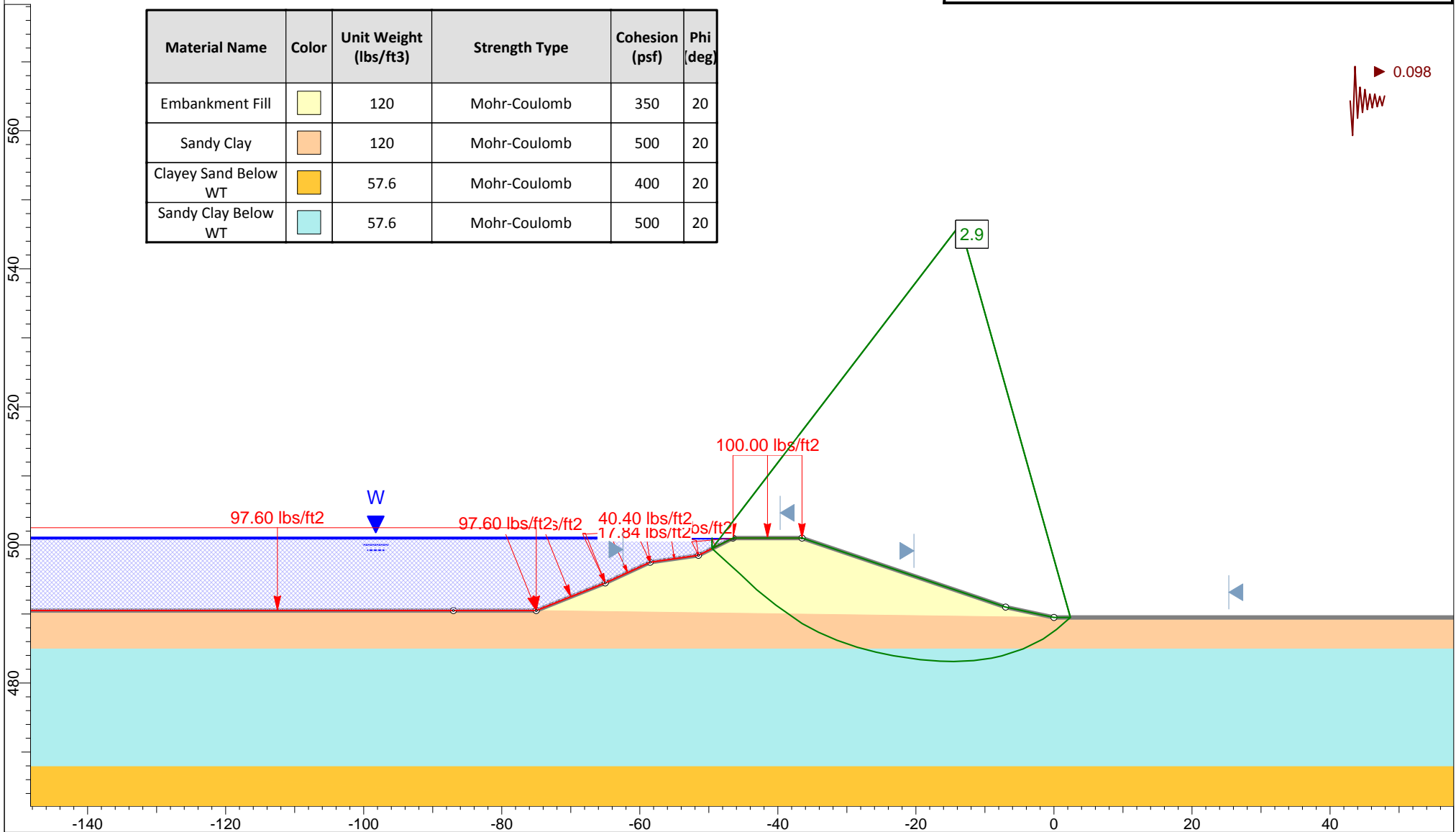

Profile "I" - Maximum Pool
Ash Pond Berms - Spruce/Deely Generation Units

Raba Kistner Consultants, Inc.
ASA12-098-00

Figure D-36a



Global Stability Analysis

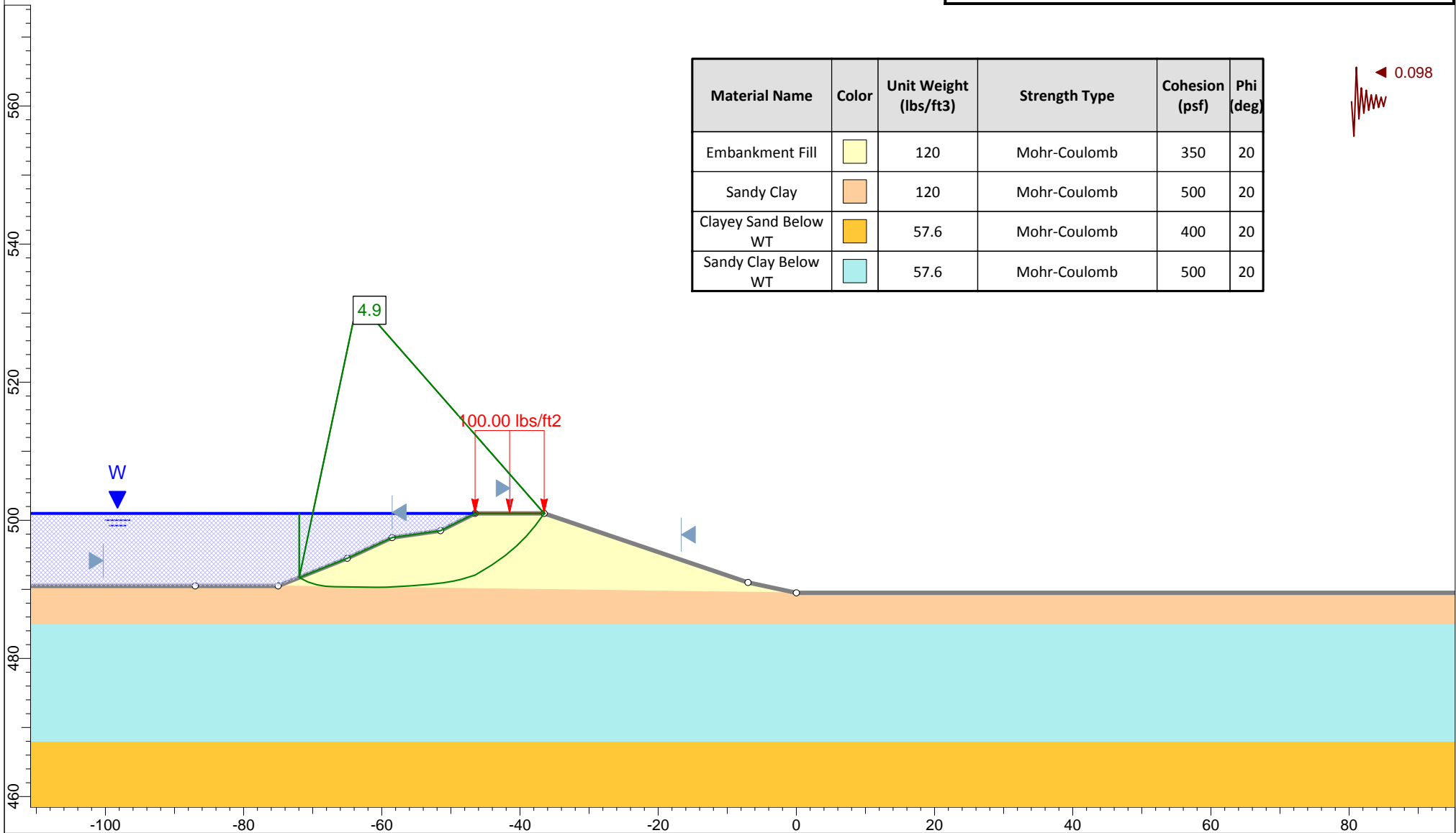

Material Name	Color	Unit Weight (lbs/ft ³)	Strength Type	Cohesion (psf)	Phi (deg)
Embankment Fill	Yellow	120	Mohr-Coulomb	350	20
Sandy Clay	Orange	120	Mohr-Coulomb	500	20
Clayey Sand Below WT	Light Blue	57.6	Mohr-Coulomb	400	20
Sandy Clay Below WT	Dark Blue	57.6	Mohr-Coulomb	500	20

0.098



Profile "I" - Maximum Pool
Ash Pond Berms - Spruce/Deely Generation Units

Raba Kistner Consultants, Inc.
ASA12-098-00

Figure D-36b



Global Stability Analysis

Material Name	Color	Unit Weight (lbs/ft ³)	Strength Type	Cohesion (psf)	Phi (deg)
Embankment Fill		120	Mohr-Coulomb	350	20
Clayey Sand		120	Mohr-Coulomb	400	20
Clayey Sand Below WT		57.6	Mohr-Coulomb	400	20

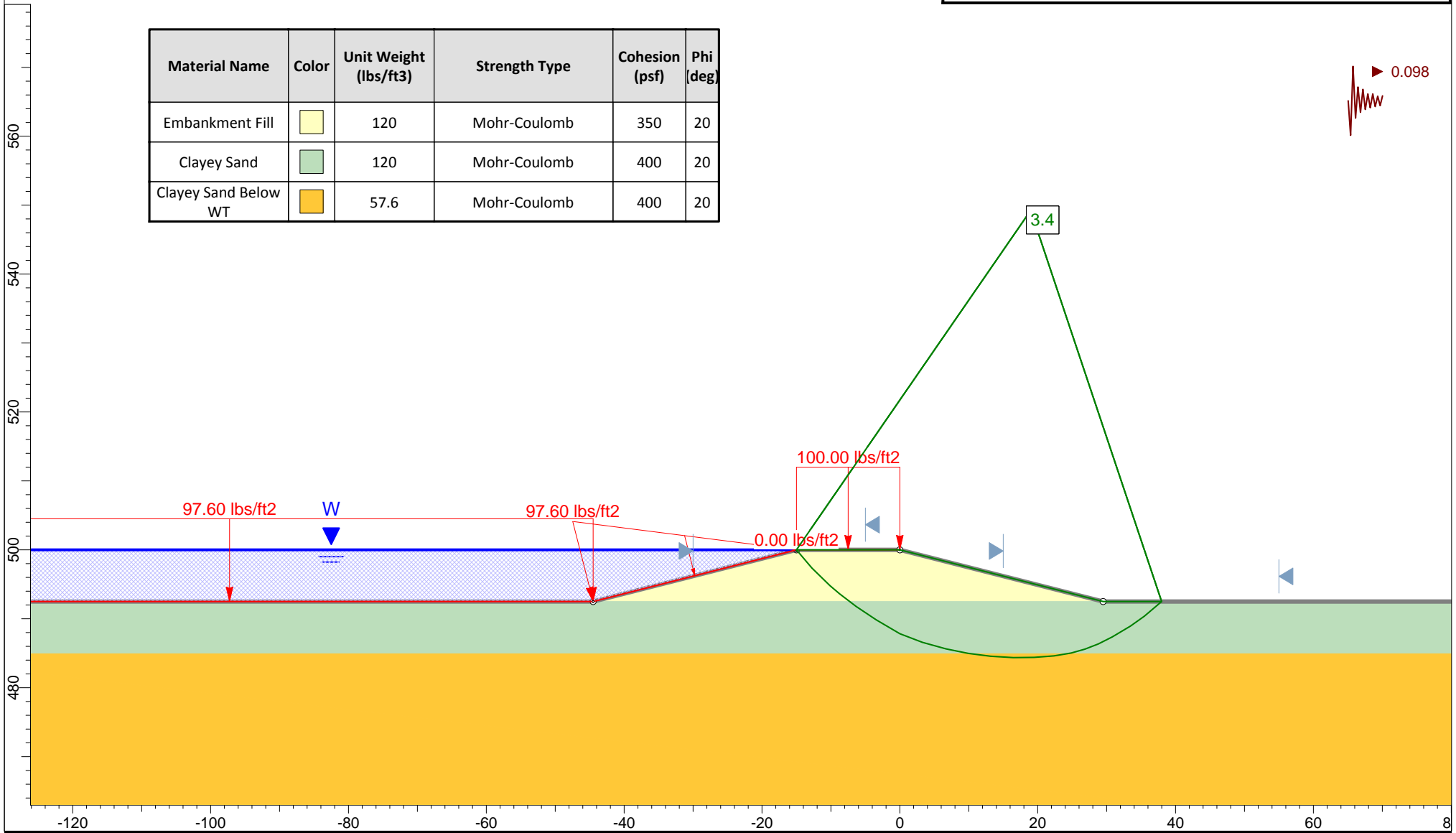



Profile "J" - Maximum Pool
Ash Pond Berms - Spruce/Deely Generation Units

Raba Kistner Consultants, Inc.
ASA12-098-00

Figure D-37a



Global Stability Analysis

Material Name	Color	Unit Weight (lbs/ft ³)	Strength Type	Cohesion (psf)	Phi (deg)
Embankment Fill		120	Mohr-Coulomb	350	20
Clayey Sand		120	Mohr-Coulomb	400	20
Clayey Sand Below WT		57.6	Mohr-Coulomb	400	20

 0.098

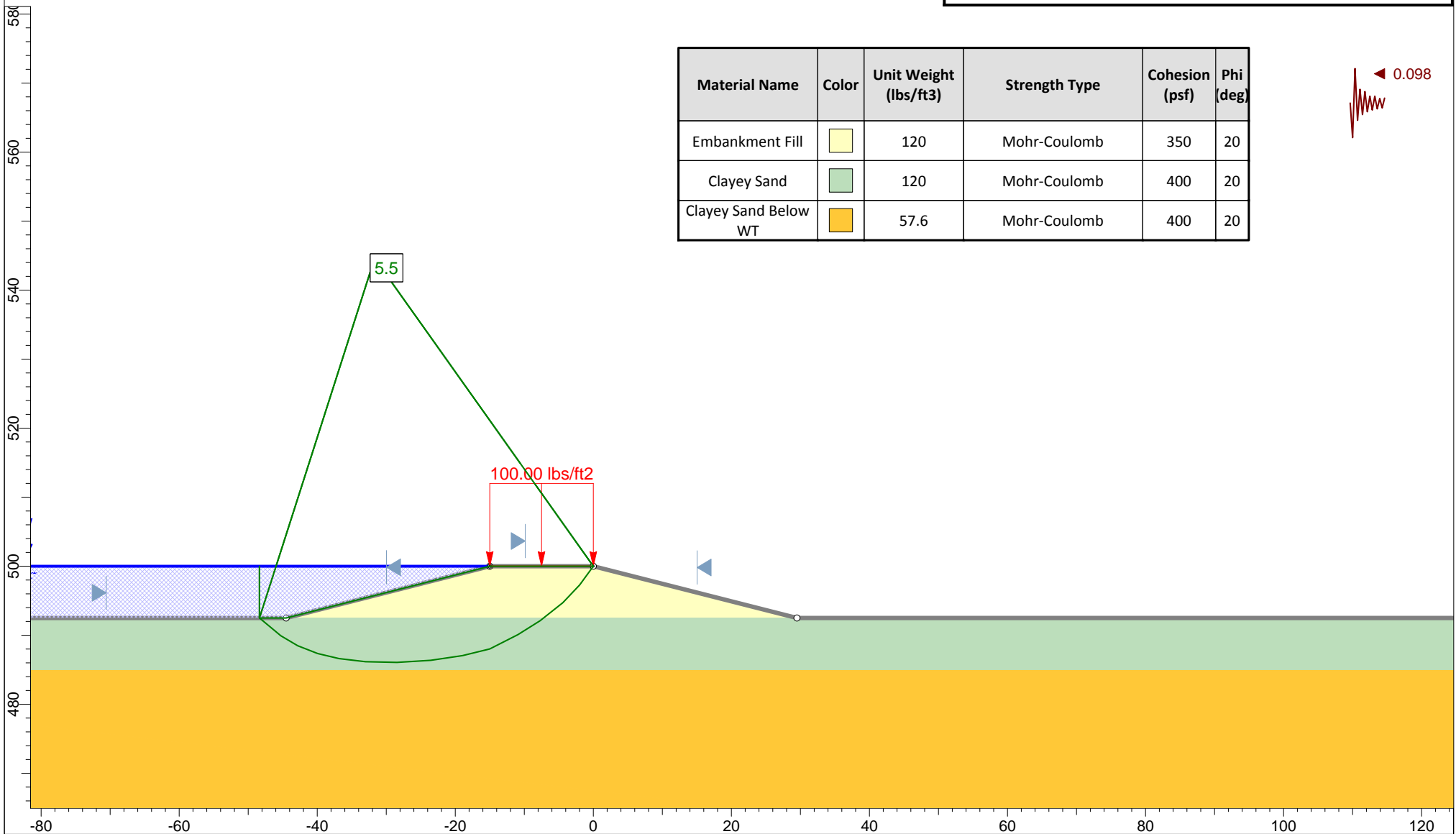



Profile "J" - Maximum Pool
Ash Pond Berms - Spruce/Deely Generation Units

Raba Kistner Consultants, Inc.
ASA12-098-00

Figure D-37b



Global Stability Analysis

Material Name	Color	Unit Weight (lbs/ft ³)	Strength Type	Cohesion (psf)	Phi (deg)
Embankment Fill		120	Mohr-Coulomb	350	20
Sandy Clay		120	Mohr-Coulomb	500	20
Sandy Clay Below WT		57.6	Mohr-Coulomb	500	20

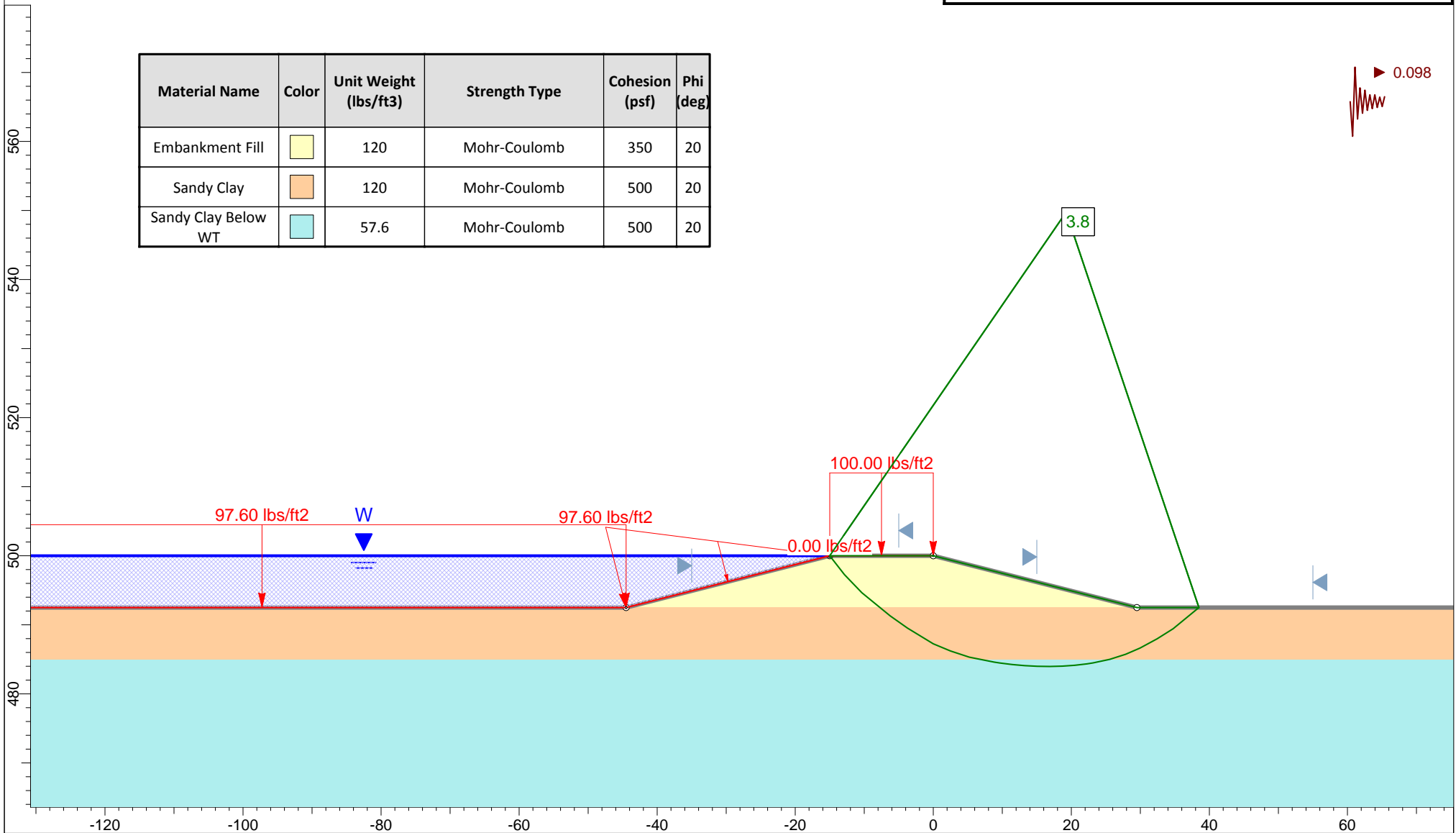

Profile "K" - Maximum Pool
Ash Pond Berms - Spruce/Deely Generation Units

Raba Kistner Consultants, Inc.
ASA12-098-00

Figure D-38a



Global Stability Analysis

Material Name	Color	Unit Weight (lbs/ft ³)	Strength Type	Cohesion (psf)	Phi (deg)
Embankment Fill	Yellow	120	Mohr-Coulomb	350	20
Sandy Clay	Orange	120	Mohr-Coulomb	500	20
Sandy Clay Below WT	Light Blue	57.6	Mohr-Coulomb	500	20

◀ 0.098

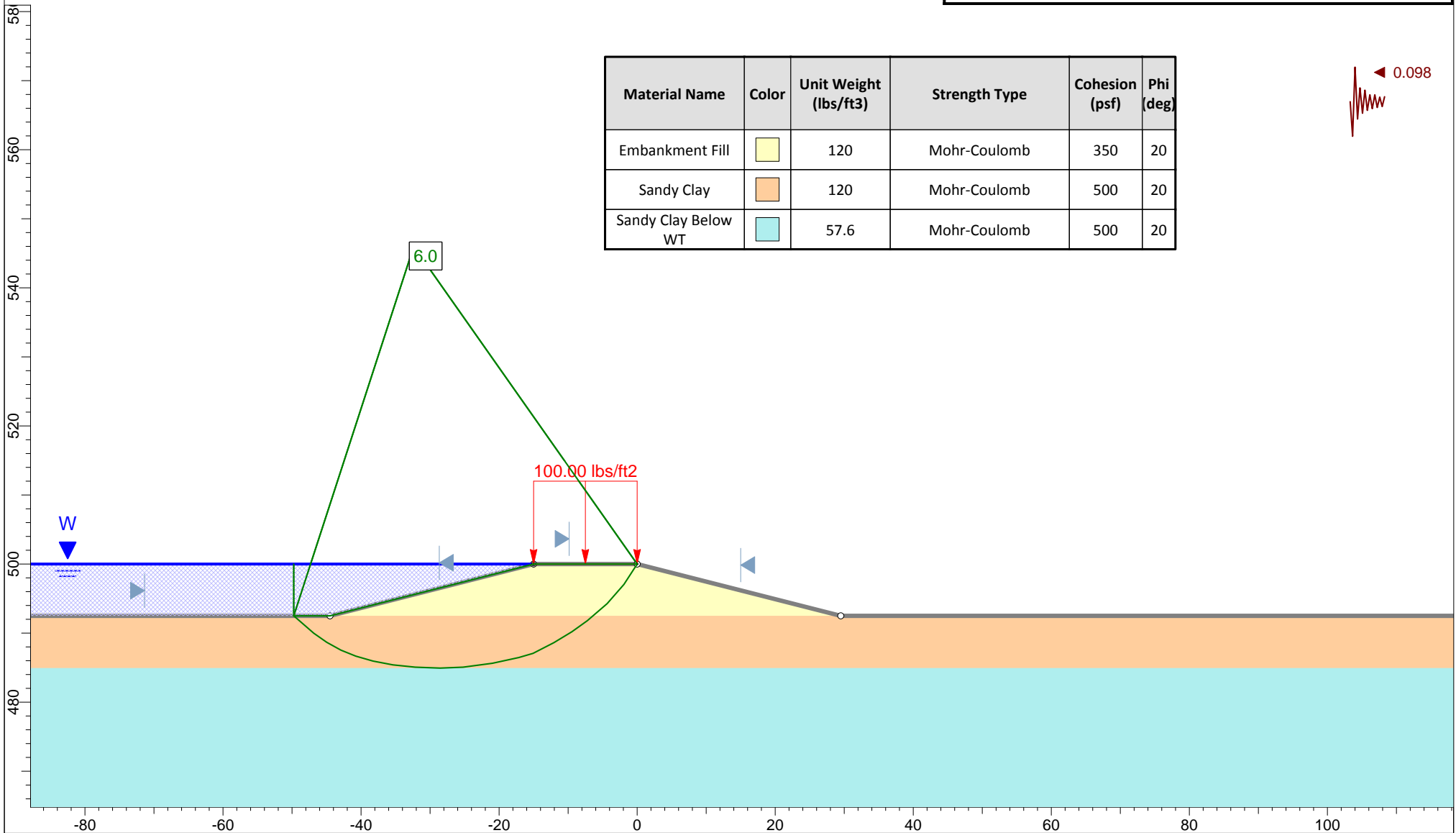





Profile "K" - Maximum Pool
Ash Pond Berms - Spruce/Deely Generation Units

Raba Kistner Consultants, Inc.
ASA12-098-00

Figure D-38b



Global Stability Analysis

Material Name	Color	Unit Weight (lbs/ft ³)	Strength Type	Cohesion (psf)	Phi (deg)
Embankment Fill		120	Mohr-Coulomb	350	20
Clayey Sand		120	Mohr-Coulomb	400	20
Clayey Sand Below WT		57.6	Mohr-Coulomb	400	20
Sandy Clay Below WT		57.6	Mohr-Coulomb	500	20

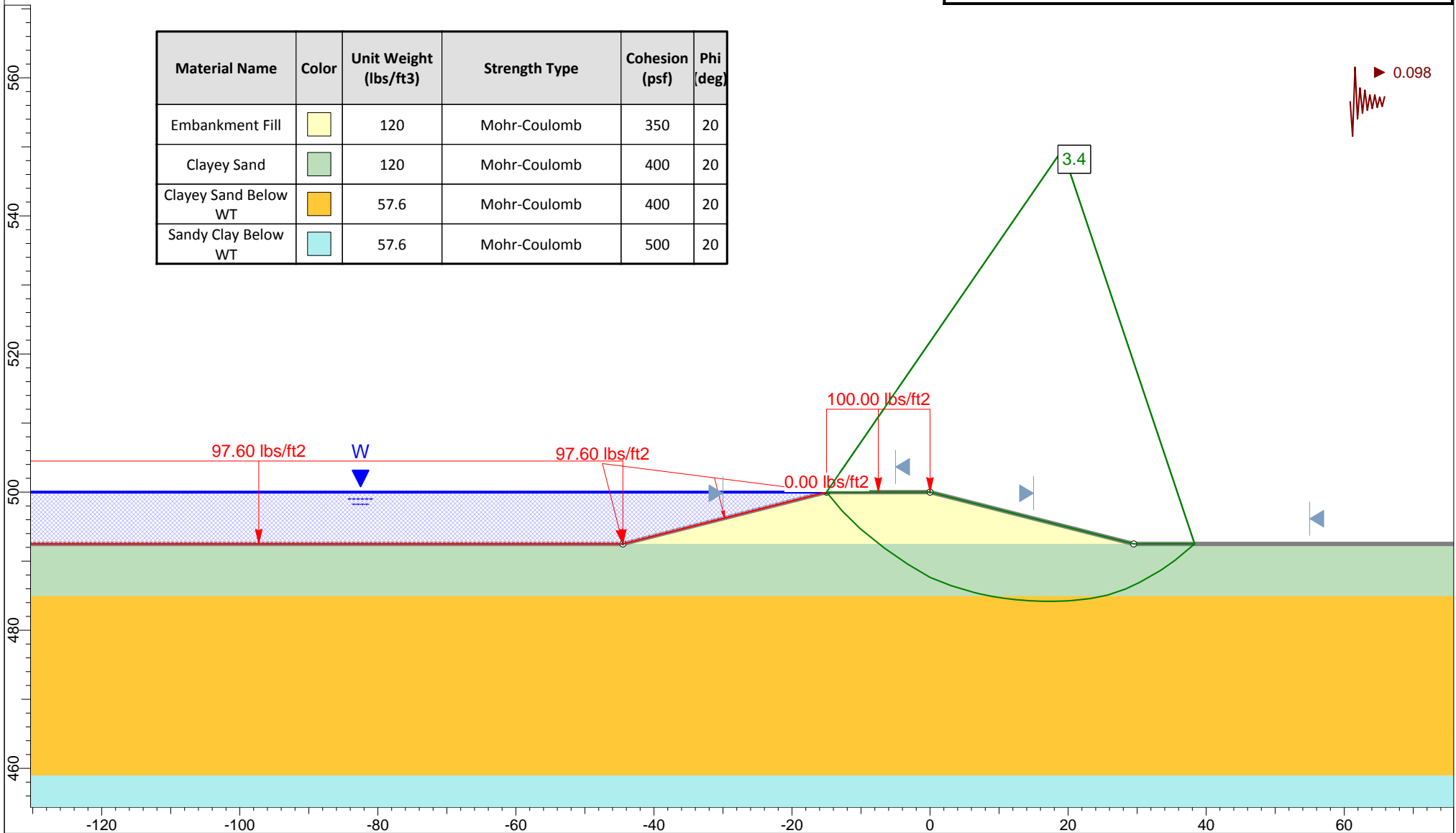

Profile "L" - Maximum Pool
Ash Pond Berms - Spruce/Deely Generation Units

Raba Kistner Consultants, Inc.
ASA12-098-00

Figure D-39a



Global Stability Analysis

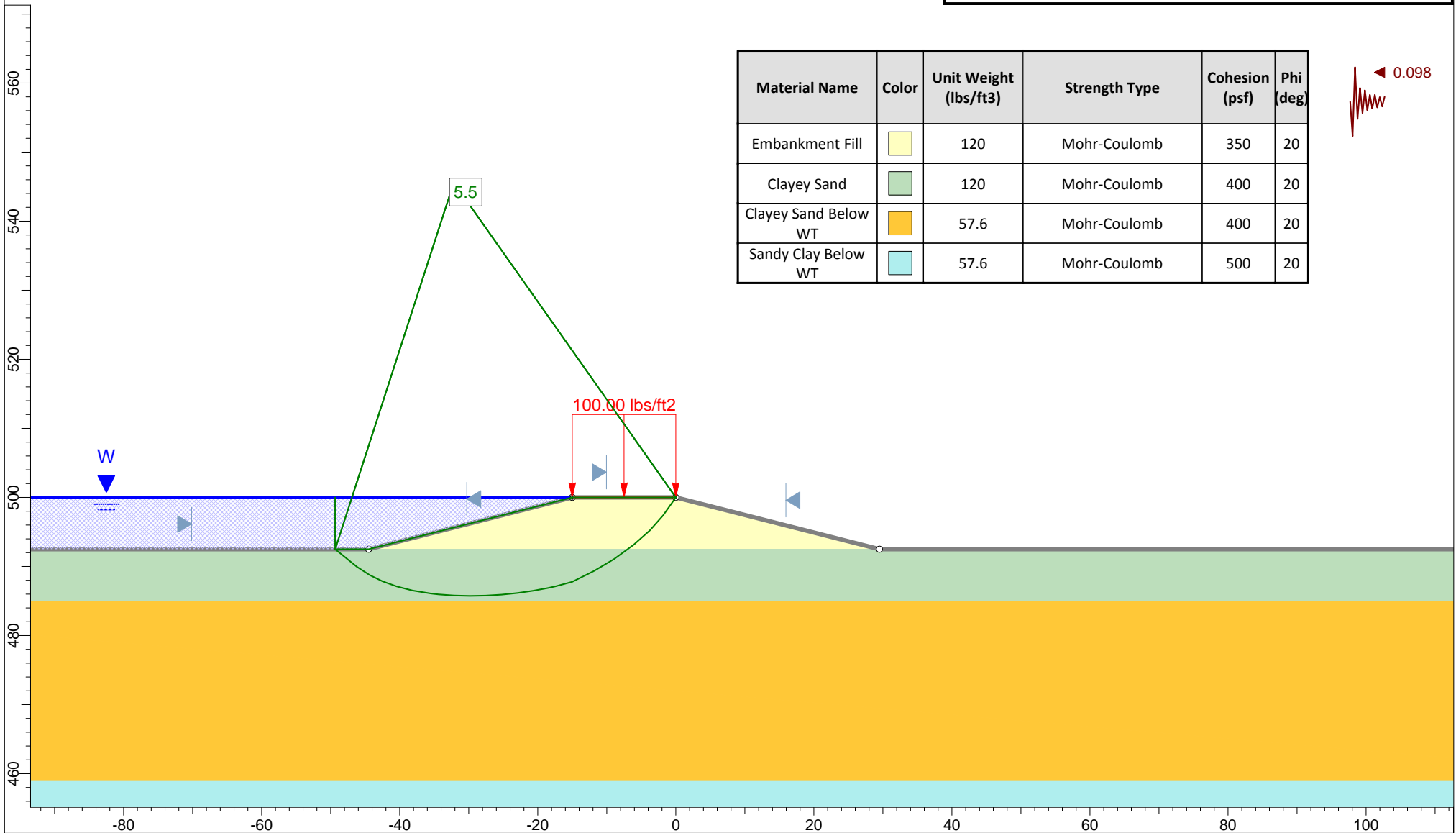





Profile "L" - Maximum Pool
Ash Pond Berms - Spruce/Deely Generation Units

Raba Kistner Consultants, Inc.
ASA12-098-00

Figure D-39b



Global Stability Analysis

Material Name	Color	Unit Weight (lbs/ft ³)	Strength Type	Cohesion (psf)	Phi (deg)
Embankment Fill		120	Mohr-Coulomb	350	20
Sandy Clay		120	Mohr-Coulomb	500	20
Clayey Sand Below WT		57.6	Mohr-Coulomb	400	20
Sandy Clay Below WT		57.6	Mohr-Coulomb	500	20

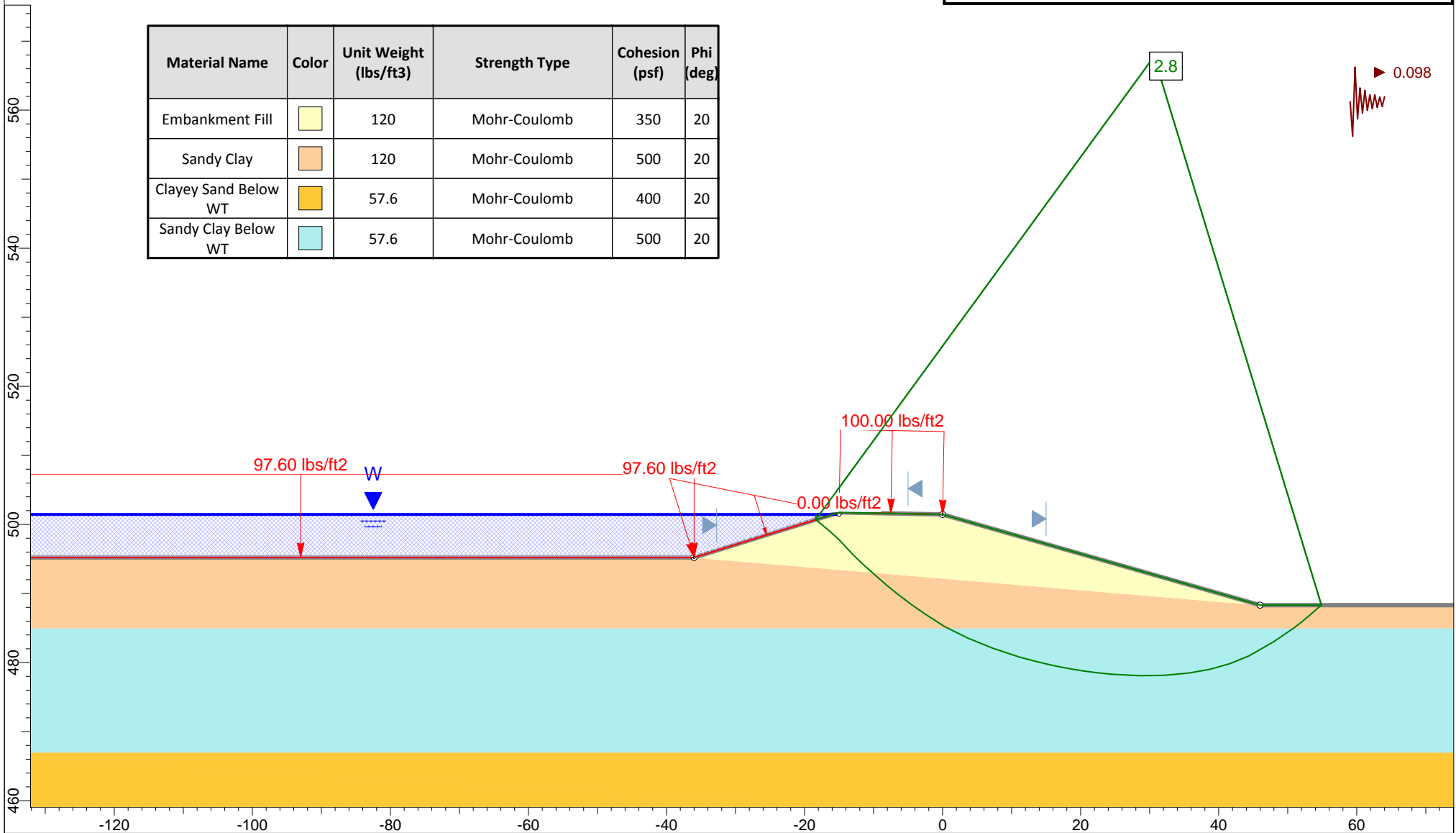

Profile "M" - Maximum Pool
Ash Pond Berms - Spruce/Deely Generation Units

Raba Kistner Consultants, Inc.
ASA12-098-00

Figure D-40a



Global Stability Analysis

Material Name	Color	Unit Weight (lbs/ft ³)	Strength Type	Cohesion (psf)	Phi (deg)
Embankment Fill	Light Yellow	120	Mohr-Coulomb	350	20
Sandy Clay	Light Orange	120	Mohr-Coulomb	500	20
Clayey Sand Below WT	Yellow	57.6	Mohr-Coulomb	400	20
Sandy Clay Below WT	Light Blue	57.6	Mohr-Coulomb </td <td>500</td> <td>20</td>	500	20

◀ 0.098

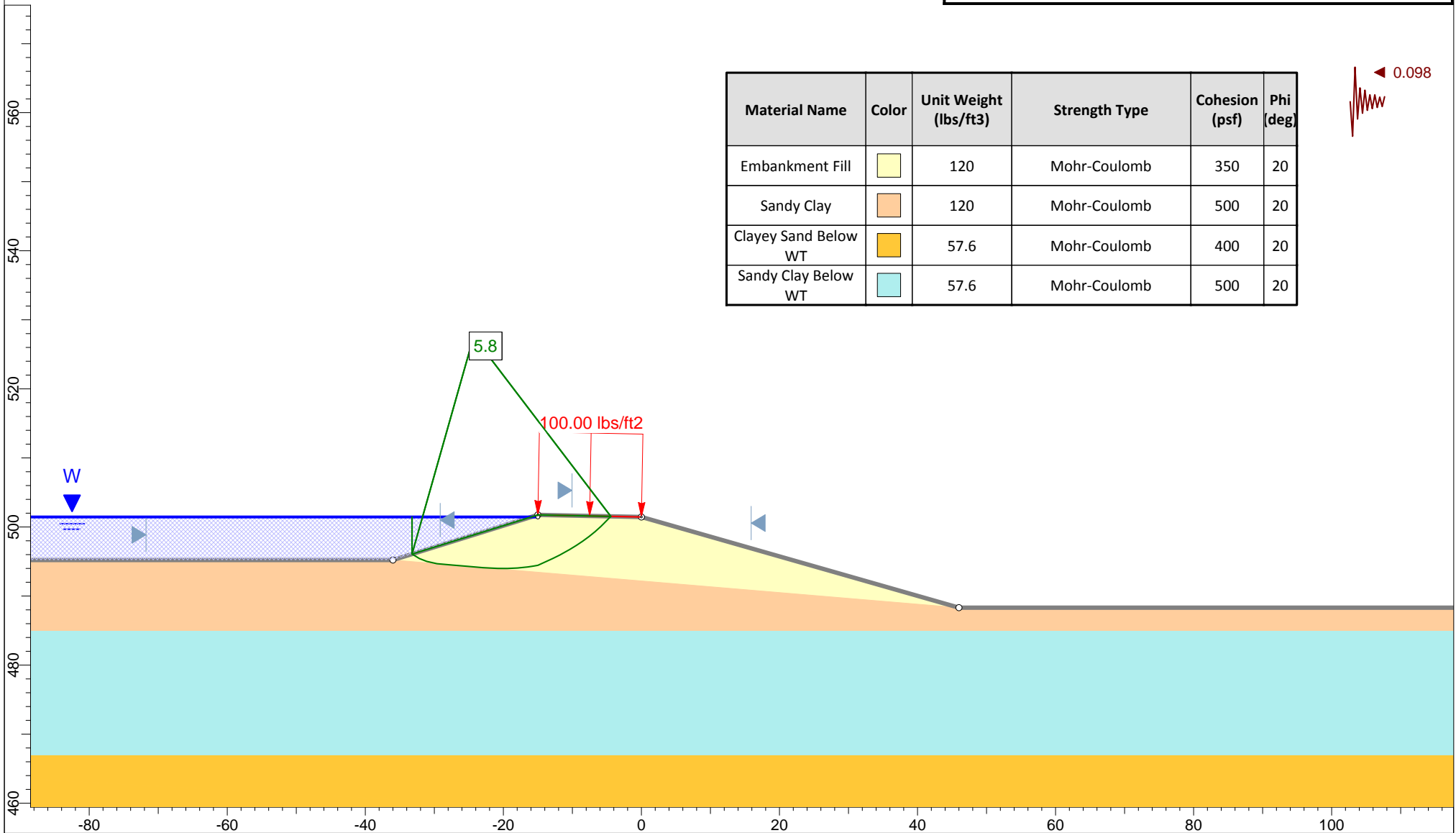



Profile "M" - Maximum Pool
Ash Pond Berms - Spruce/Deely Generation Units

Raba Kistner Consultants, Inc.
ASA12-098-00

Figure D-40b



Global Stability Analysis

Material Name	Color	Unit Weight (lbs/ft ³)	Strength Type	Cohesion (psf)	Phi (deg)
Embankment Fill		120	Mohr-Coulomb	350	20
Clayey Sand		120	Mohr-Coulomb	400	20
Clayey Sand Below WT		57.6	Mohr-Coulomb	400	20

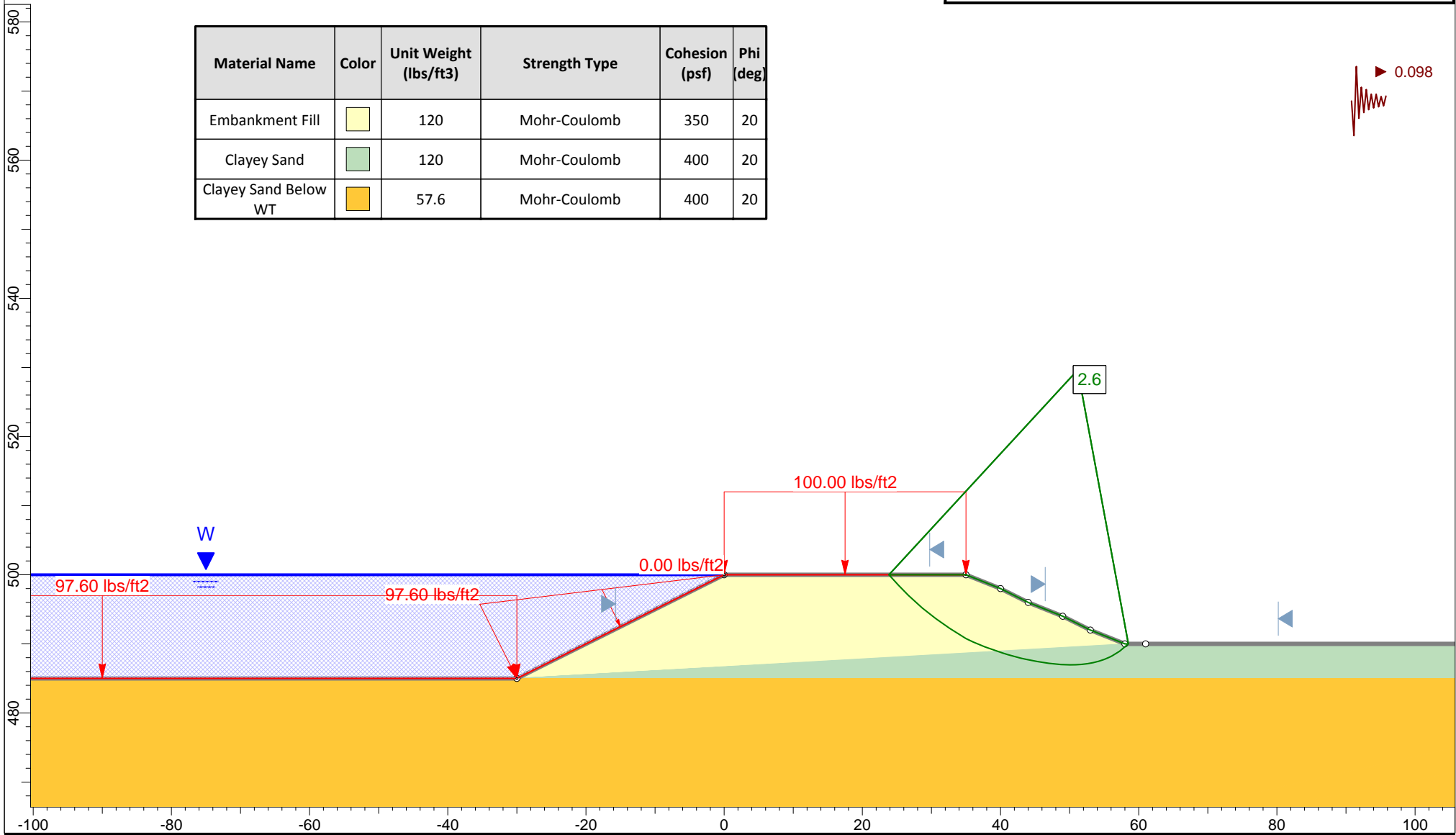

Profile "N" - Maximum Pool
Ash Pond Berms - Spruce/Deely Generation Units

Raba Kistner Consultants, Inc.
ASA12-098-00

Figure D-41a



Global Stability Analysis

Material Name	Color	Unit Weight (lbs/ft ³)	Strength Type	Cohesion (psf)	Phi (deg)
Embankment Fill	Yellow	120	Mohr-Coulomb	350	20
Clayey Sand	Green	120	Mohr-Coulomb	400	20
Clayey Sand Below WT	Orange	57.6	Mohr-Coulomb	400	20

◀ 0.098

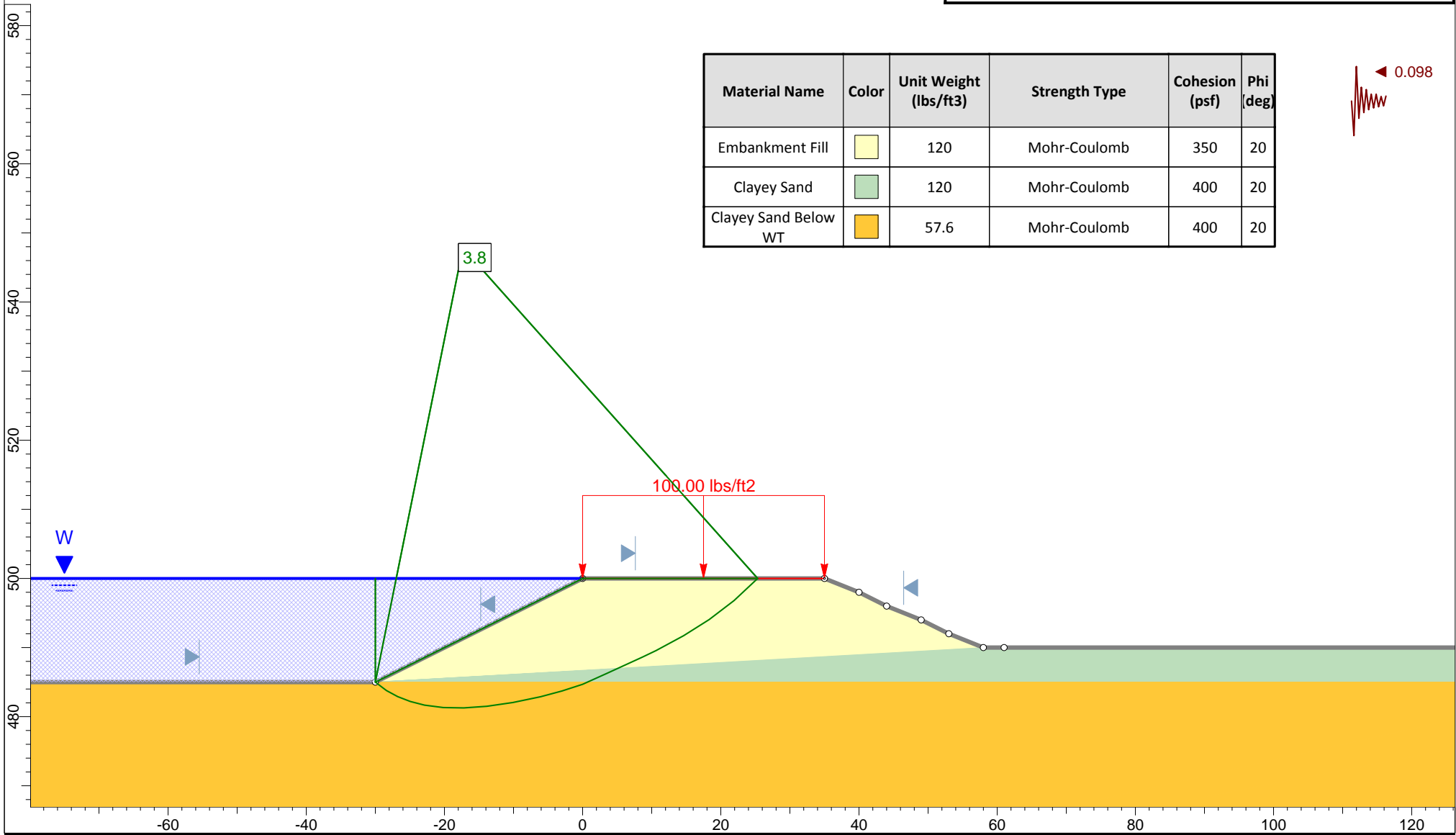

Profile "N" - Maximum Pool
Ash Pond Berms - Calaveras Lake Power Plant

Raba Kistner Consultants, Inc.
ASA12-098-00

Figure D-41b



Appendix B
USEPA Checklists



Site Name: JT Deely Power Plant	Date: August 27, 2012
Unit Name: North Bottom Ash Pond	Operator's Name: CPS Energy
Unit I.D.:	Hazard Potential Classification: High Significant Low
Inspector's Name: Jamal Daas/Bevin Barringer	

Check the appropriate box below. Provide comments when appropriate. If not applicable or not available, record "N/A". Any unusual conditions or construction practices that should be noted in the comments section. For large diked embankments, separate checklists may be used for different embankment areas. If separate forms are used, identify approximate area that the form applies to in comments.

	Yes	No		Yes	No
1. Frequency of Company's Dam Inspections?		none	18. Sloughing or bulging on slopes?		X
2. Pool elevation (operator records)?		499.0	19. Major erosion or slope deterioration?		X
3. Decant inlet elevation (operator records)?		499.0	20. Decant Pipes:		
4. Open channel spillway elevation (operator records)?		DNA	Is water entering inlet, but not exiting outlet?		X
5. Lowest dam crest elevation (operator records)?		501.0	Is water exiting outlet, but not entering inlet?		X
6. If instrumentation is present, are readings recorded (operator records)?		DNA	Is water exiting outlet flowing clear?	see	note
7. Is the embankment currently under construction?		X	21. Seepage (specify location, if seepage carries fines, and approximate seepage rate below):		
8. Foundation preparation (remove vegetation, stumps, topsoil in area where embankment fill will be placed)?	X		From underdrain?	DNA	
9. Trees growing on embankment? (If so, indicate largest diameter below)	X		At isolated points on embankment slopes?		X
10. Cracks or scarps on crest?		X	At natural hillside in the embankment area?		X
11. Is there significant settlement along the crest?		X	Over widespread areas?		X
12. Are decant trashracks clear and in place?	X		From downstream foundation area?		X
13. Depressions or sinkholes in tailings surface or whirlpool in the pool area?		X	"Boils" beneath stream or ponded water?		X
14. Clogged spillways, groin or diversion ditches?		DNA	Around the outside of the decant pipe?		X
15. Are spillway or ditch linings deteriorated?		DNA	22. Surface movements in valley bottom or on hillside?		X
16. Are outlets of decant or underdrains blocked?		X	23. Water against downstream toe?	X	
17. Cracks or scarps on slopes?		X	24. Were Photos taken during the dam inspection?	X	

Major adverse changes in these items could cause instability and should be reported for further evaluation. Adverse conditions noted in these items should normally be described (extent, location, volume, etc.) in the space below and on the back of this sheet.

Inspection Issue # Comments

1. No formal inspections are performed. Once every 12-hr shift, staff records water level in impoundment and will make notes if anything irregular is noted.

6. Once every 12-hr shift staff records water level by measuring water level referenced to the decant inlet at El. 499 ft.

9. Largest diameter tree is approximately 8 inches in diameter.

20. Decant outlet at El. 499 was clear. Pipe outlet at El. 489 was submerged.

23. #1 Stormwater Runoff Pond is located at the west embankment exterior toe. The Bottom Ash Pond-South is located at the south embankment exterior slope.



Coal Combustion Waste (CCW) Impoundment Inspection

Impoundment NPDES Permit # WQ0001514000
Date August 27, 2012

INSPECTOR Jamal Daas/Bevin Barringer

Impoundment Name Bottom Ash Pond - North
Impoundment Company CPS Energy
EPA Region 6
State Agency (Field Office) Address Texas Commission on Environmental Quality
12110 Park 35 Circle, Austin, TX 78753

Name of Impoundment Bottom Ash Pond - North
(Report each impoundment on a separate form under the same Impoundment NPDES Permit number)

New [x] Update

Is impoundment currently under construction? [] Yes [x] No
Is water or ccw currently being pumped into the impoundment? [x] Yes [] No

Stores bottom ash transport water, low volume waste, and metal cleaning waste.
IMPOUNDMENT FUNCTION:

Nearest Downstream Town: Name Elmendorf, TX
Distance from the impoundment 3.5 miles
Impoundment Location: Longitude 98 Degrees 18 Minutes 58 Seconds
Latitude 29 Degrees 18 Minutes 31 Seconds
State TX County Bexar

Does a state agency regulate this impoundment? YES [x] NO

If So Which State Agency? Texas Commission on Environmental Quality

HAZARD POTENTIAL (In the event the impoundment should fail, the following would occur):

 LESS THAN LOW HAZARD POTENTIAL: Failure or misoperation of the dam results in no probable loss of human life or economic or environmental losses.

 LOW HAZARD POTENTIAL: Dams assigned the low hazard potential classification are those where failure or misoperation results in no probable loss of human life and low economic and/or environmental losses. Losses are principally limited to the owner's property.

 x **SIGNIFICANT HAZARD POTENTIAL:** Dams assigned the significant hazard potential classification are those dams where failure or misoperation results in no probable loss of human life but can cause economic loss, environmental damage, disruption of lifeline facilities, or can impact other concerns. Significant hazard potential classification dams are often located in predominantly rural or agricultural areas but could be located in areas with population and significant infrastructure.

 HIGH HAZARD POTENTIAL: Dams assigned the high hazard potential classification are those where failure or misoperation will probably cause loss of human life.

DESCRIBE REASONING FOR HAZARD RATING CHOSEN:

Because the impoundment shares a common embankment with the #1 Stormwater Runoff Pond and the Bottom Ash Pond - South, failure or misoperation of the Bottom Ash Pond - North could result in flow into the Bottom Ash Pond South and the #1 Stormwater Runoff Pond causing subsequent failure toward the plant facility.
No loss of human life however there would be environmental damage, economic losses and disruption of lifeline facilities.

CONFIGURATION:

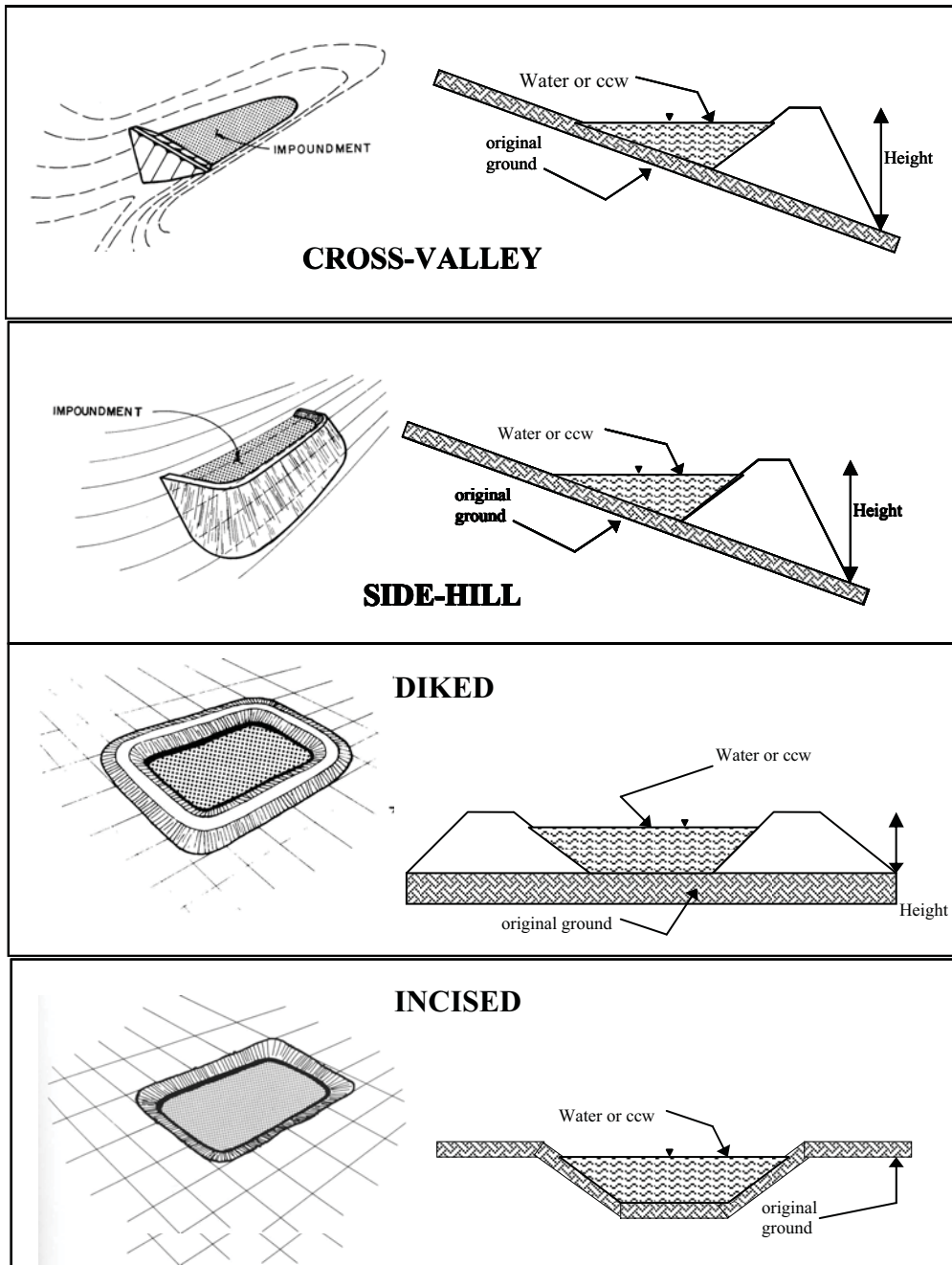

- Cross-Valley
- Side-Hill
- Diked
- Incised (form completion optional)
- Combination Incised/Diked

Embankment Height 12 feet Embankment Material Cohesive material
 Pool Area 6 acres Liner none
 Current Freeboard 2 feet Liner Permeability DNA

TYPE OF OUTLET (Mark all that apply)

 Open Channel Spillway

- Trapezoidal
- Triangular
- Rectangular
- Irregular

- depth
- bottom (or average) width
- top width

TRAPEZOIDAL

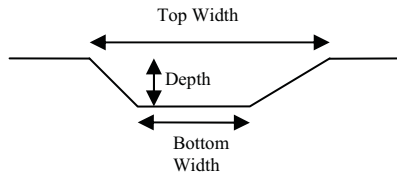

TRIANGULAR

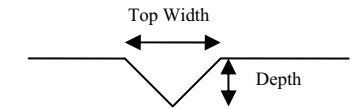

RECTANGULAR

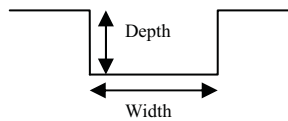

IRREGULAR

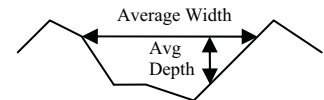

 X **Outlet**

 2-12 " inside diameter

Material

- corrugated metal
- X welded steel
- concrete
- plastic (hdpe, pvc, etc.)
- other (specify) _____

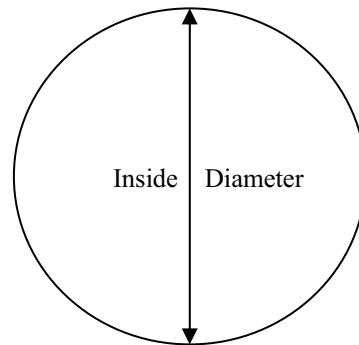

Is water flowing through the outlet? YES X NO _____

 No Outlet

 Other Type of Outlet (specify) _____

The Impoundment was Designed By Black & Veatch Consulting Engineers



ADDITIONAL INSPECTION QUESTIONS

Concerning the embankment foundation, was the embankment construction built over wet ash, slag, or other unsuitable materials? If there is no information just note that.

It does not appear the North Bottom Ash Pond embankments were constructed over wet ash, slag or other unsuitable materials. Historical information provided by CPS indicates the North Bottom Ash Pond was constructed in 1977. Borings performed in 2012 by Raba Kistner Consultants, Inc., indicate embankments bear on native material consisting of sandy clay and clayey sand with isolated tan and gray clay seams.

Did the dam assessor meet with, or have documentation from, the design Engineer-of-Record concerning the foundation preparation?

The assessor did not meet with, or have documentation from, the design Engineer of Record concerning foundation preparation.

From the site visit or from photographic documentation, was there evidence of prior releases, failures, or patchwork on the dikes?

There was no indication of prior releases, failures or patchwork on the embankments.



Site Name: JT Deely Power Plant	Date: August 27, 2012
Unit Name: South Bottom Ash Pond	Operator's Name: CPS Energy
Unit I.D.:	Hazard Potential Classification: High Significant Low
Inspector's Name: Jamal Daas/Bevin Barringer	

Check the appropriate box below. Provide comments when appropriate. If not applicable or not available, record "N/A". Any unusual conditions or construction practices that should be noted in the comments section. For large diked embankments, separate checklists may be used for different embankment areas. If separate forms are used, identify approximate area that the form applies to in comments.

	Yes	No		Yes	No
1. Frequency of Company's Dam Inspections?		none	18. Sloughing or bulging on slopes?		X
2. Pool elevation (operator records)?		491.0	19. Major erosion or slope deterioration?		X
3. Decant inlet elevation (operator records)?		499.0	20. Decant Pipes:		
4. Open channel spillway elevation (operator records)?		499.5	Is water entering inlet, but not exiting outlet?		X
5. Lowest dam crest elevation (operator records)?		501.0	Is water exiting outlet, but not entering inlet?		X
6. If instrumentation is present, are readings recorded (operator records)?		DNA	Is water exiting outlet flowing clear?	DNA	
7. Is the embankment currently under construction?		X	21. Seepage (specify location, if seepage carries fines, and approximate seepage rate below):		
8. Foundation preparation (remove vegetation, stumps, topsoil in area where embankment fill will be placed)?		X	From underdrain?	DNA	
9. Trees growing on embankment? (If so, indicate largest diameter below)		X	At isolated points on embankment slopes?		X
10. Cracks or scarps on crest?		X	At natural hillside in the embankment area?		X
11. Is there significant settlement along the crest?		X	Over widespread areas?		X
12. Are decant trashracks clear and in place?		see note	From downstream foundation area?		X
13. Depressions or sinkholes in tailings surface or whirlpool in the pool area?		DNA	"Boils" beneath stream or ponded water?		X
14. Clogged spillways, groin or diversion ditches?		X	Around the outside of the decant pipe?		X
15. Are spillway or ditch linings deteriorated?		X	22. Surface movements in valley bottom or on hillside?		X
16. Are outlets of decant or underdrains blocked?		X	23. Water against downstream toe?	X	
17. Cracks or scarps on slopes?		X	24. Were Photos taken during the dam inspection?	X	

Major adverse changes in these items could cause instability and should be reported for further evaluation. Adverse conditions noted in these items should normally be described (extent, location, volume, etc.) in the space below and on the back of this sheet.

<u>Inspection Issue #</u>	<u>Comments</u>
1.	No formal inspections are performed. Once every 12-hr shift, staff records water level in impoundment and will make notes if anything irregular is noted.
2.	Impoundment was drained of water for cleaning during the assessment. Dry bottom ash in the pond ranged from El.489 to 491.
12.	Sheet pile wall and sorbent was observed near the outlet pipes at the southeast corner of the impoundment.
23.	Drainage ditch located at south embankment exterior toe. Bot. Ash Pond - North is located at the north embankment exterior slope. SRH Pond is located at the west embankment exterior slope.

EPA FORM -XXXX

N/A=not available
DNA=does not apply



Coal Combustion Waste (CCW) Impoundment Inspection

Impoundment NPDES Permit # WQ0001514000
Date August 27, 2012

INSPECTOR Jamal Daas/Bevin Barringer

Impoundment Name Botto, Ash Pond - South
Impoundment Company CPS Energy
EPA Region 6

State Agency (Field Office) Address Texas Commission on Environmental Quality
12110 Park 35 Circle, Austin, TX 78753

Name of Impoundment Bottom Ash Pond - South
(Report each impoundment on a separate form under the same Impoundment NPDES Permit number)

New [x] Update

Is impoundment currently under construction? Yes No
Is water or ccw currently being pumped into the impoundment? Yes No

Stores bottom ash transport water, low volume
IMPOUNDMENT FUNCTION: waste, and metal cleaning waste.

Nearest Downstream Town: Name Elmendorf, TX
Distance from the impoundment 3.5 miles
Impoundment Location: Longitude 98 Degrees 18 Minutes 58 Seconds
Latitude 29 Degrees 18 Minutes 27 Seconds
State TX County Bexar

Does a state agency regulate this impoundment? YES [x] NO

If So Which State Agency? Texas Commission on Environmental Quality

HAZARD POTENTIAL (In the event the impoundment should fail, the following would occur):

 LESS THAN LOW HAZARD POTENTIAL: Failure or misoperation of the dam results in no probable loss of human life or economic or environmental losses.

 LOW HAZARD POTENTIAL: Dams assigned the low hazard potential classification are those where failure or misoperation results in no probable loss of human life and low economic and/or environmental losses. Losses are principally limited to the owner's property.

 X **SIGNIFICANT HAZARD POTENTIAL:** Dams assigned the significant hazard potential classification are those dams where failure or misoperation results in no probable loss of human life but can cause economic loss, environmental damage, disruption of lifeline facilities, or can impact other concerns. Significant hazard potential classification dams are often located in predominantly rural or agricultural areas but could be located in areas with population and significant infrastructure.

 HIGH HAZARD POTENTIAL: Dams assigned the high hazard potential classification are those where failure or misoperation will probably cause loss of human life.

DESCRIBE REASONING FOR HAZARD RATING CHOSEN:

Because the impoundment shares a common embankment with the SRH Pond, failure or misoperation of the Bot. Ash Pond-South could result in flow into the SRH Pond, and subsequent failure of the SRH Pond. If the SRH Pond fails, liquid would likely flow toward the plant facility which is 100 feet east of the SRH Pond. There would be no probable loss of human life, but there be economic loss, environmental damage and disruption of lifeline facilities.

CONFIGURATION:

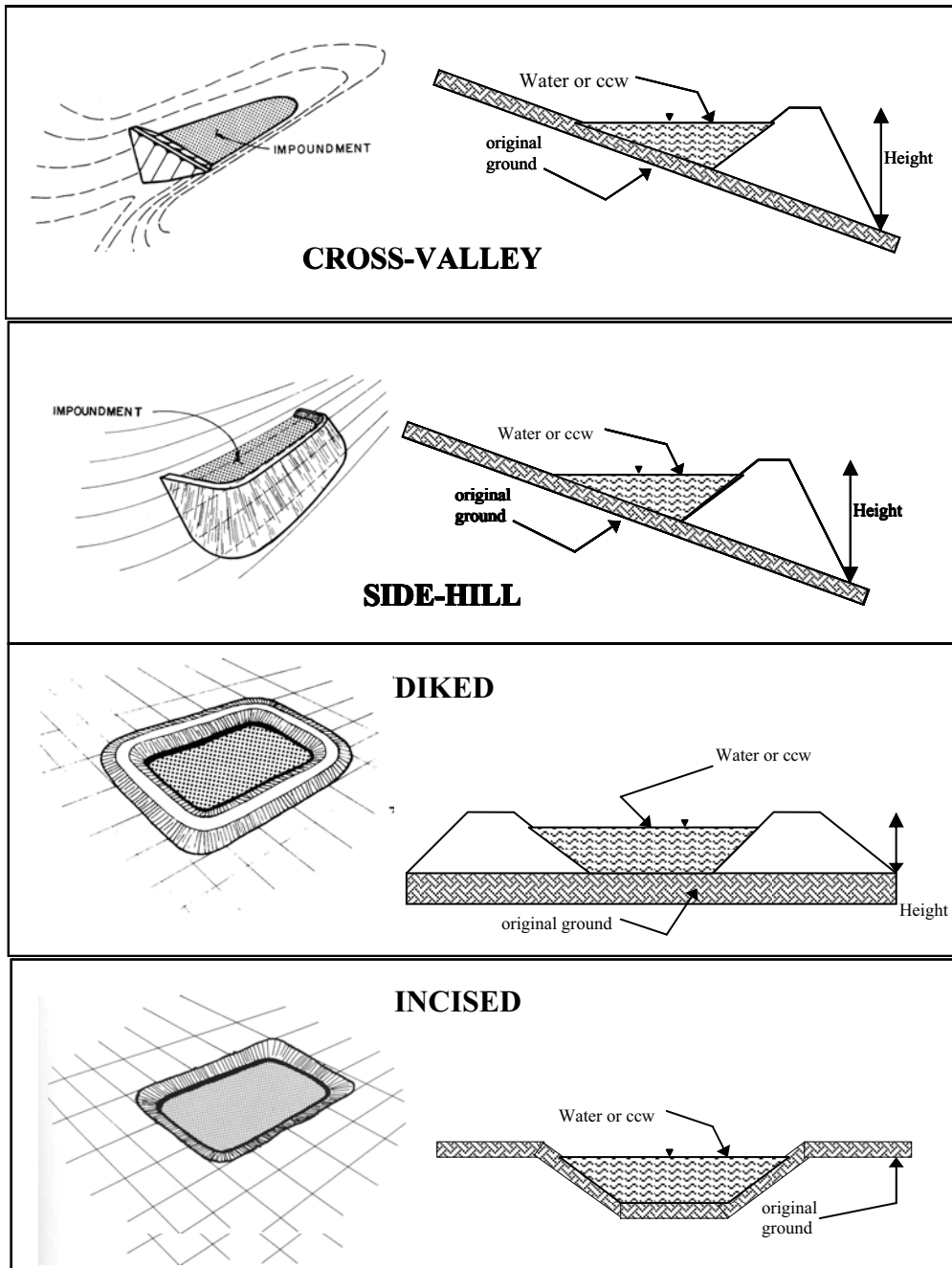

- Cross-Valley
- Side-Hill
- Diked
- Incised (form completion optional)
- Combination Incised/Diked

Embankment Height 12 feet Embankment Material Cohesive material
 Pool Area 7 acres Liner none
 Current Freeboard 9 feet Liner Permeability DNA

TYPE OF OUTLET (Mark all that apply)

 Open Channel Spillway

- Trapezoidal
- Triangular
- Rectangular
- Irregular

- depth
- bottom (or average) width
- top width

TRAPEZOIDAL

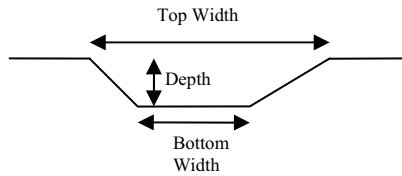

TRIANGULAR

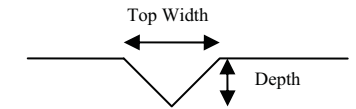

RECTANGULAR

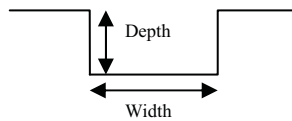

IRREGULAR

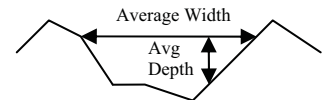

 X **Outlet**

 2-12 " inside diameter

Material

- corrugated metal
- X welded steel
- concrete
- plastic (hdpe, pvc, etc.)
- other (specify) _____

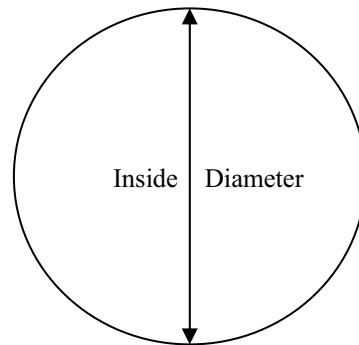

Is water flowing through the outlet? YES _____ NO X

 No Outlet

 Other Type of Outlet (specify) _____

The Impoundment was Designed By Black & Veatch Consulting Engineers



ADDITIONAL INSPECTION QUESTIONS

Concerning the embankment foundation, was the embankment construction built over wet ash, slag, or other unsuitable materials? If there is no information just note that.

It does not appear the South Bottom Ash Pond was constructed over wet ash, slag, or other unsuitable material. Historical information provided by CPS indicates the South Bottom Ash Pond was constructed in 1977. Borings performed in 2012 by Raba Kistner Consultants, Inc., indicate the embankments bear on native material consisting of sandy clay, clayey sand and isolated gray clay seams.

Did the dam assessor meet with, or have documentation from, the design Engineer-of-Record concerning the foundation preparation?

The assessor did not meet with, or have documentation from, the design Engineer of Record concerning foundation preparation.

From the site visit or from photographic documentation, was there evidence of prior releases, failures, or patchwork on the dikes?

There was no indication of prior releases, failures or patchwork on the embankments.



Site Name: JK Spruce/JT Deely Power Plants	Date: August 28, 2012
Unit Name: Evaporation Pond	Operator's Name: CPS Energy
Unit I.D.:	Hazard Potential Classification: High Significant Low
Inspector's Name: Jamal Daas/Bevin Barringer	

Check the appropriate box below. Provide comments when appropriate. If not applicable or not available, record "N/A". Any unusual conditions or construction practices that should be noted in the comments section. For large diked embankments, separate checklists may be used for different embankment areas. If separate forms are used, identify approximate area that the form applies to in comments.

	<u>Yes</u>	<u>No</u>		<u>Yes</u>	<u>No</u>
1. Frequency of Company's Dam Inspections?		none	18. Sloughing or bulging on slopes?		X
2. Pool elevation (operator records)?		N/A	19. Major erosion or slope deterioration?		X
3. Decant inlet elevation (operator records)?		DNA	20. Decant Pipes:		
4. Open channel spillway elevation (operator records)?		DNA	Is water entering inlet, but not exiting outlet?	DNA	
5. Lowest dam crest elevation (operator records)?		N/A	Is water exiting outlet, but not entering inlet?	DNA	
6. If instrumentation is present, are readings recorded (operator records)?		DNA	Is water exiting outlet flowing clear?	DNA	
7. Is the embankment currently under construction?		X	21. Seepage (specify location, if seepage carries fines, and approximate seepage rate below):		
8. Foundation preparation (remove vegetation, stumps, topsoil in area where embankment fill will be placed)?		N/A	From underdrain?	DNA	
9. Trees growing on embankment? (If so, indicate largest diameter below)		X	At isolated points on embankment slopes?		X
10. Cracks or scarps on crest?		X	At natural hillside in the embankment area?		X
11. Is there significant settlement along the crest?		X	Over widespread areas?		X
12. Are decant trashracks clear and in place?		DNA	From downstream foundation area?		X
13. Depressions or sinkholes in tailings surface or whirlpool in the pool area?		X	"Boils" beneath stream or ponded water?		X
14. Clogged spillways, groin or diversion ditches?		DNA	Around the outside of the decant pipe?	DNA	
15. Are spillway or ditch linings deteriorated?		DNA	22. Surface movements in valley bottom or on hillside?		X
16. Are outlets of decant or underdrains blocked?		DNA	23. Water against downstream toe?		X
17. Cracks or scarps on slopes?		X	24. Were Photos taken during the dam inspection?	X	

Major adverse changes in these items could cause instability and should be reported for further evaluation. Adverse conditions noted in these items should normally be described (extent, location, volume, etc.) in the space below and on the back of this sheet.

<u>Inspection Issue #</u>	<u>Comments</u>
1.	No formal inspections are performed.
2., 5., 8.	No construction drawings or design information was provided for this pond. The evaporation pond was constructed on top of a capped fly ash storage pond, based on information provided by CPS. The evaporation pond has no inlets or outlets. All material is brought in by truck for dewatering.
3., 4., 12., 14., 15., 16., 20., 21.	There are no inlets or outlets.
9.	Largest tree diameter is approximately 6 inches in diameter.



Coal Combustion Waste (CCW) Impoundment Inspection

Impoundment NPDES Permit # WQ0001514000
Date August 28, 2012

INSPECTOR Jamal Daas/Bevin Barringer

Impoundment Name Evaporation Pond
Impoundment Company CPS Energy
EPA Region 6
State Agency (Field Office) Address Texas Commission on Environmental Quality
12110 Park 35 Circle, Austin, TX 78753

Name of Impoundment Evaporation Pond
(Report each impoundment on a separate form under the same Impoundment NPDES Permit number)

New [x] Update

Is impoundment currently under construction? Yes No
Is water or ccw currently being pumped into the impoundment? Yes No

IMPOUNDMENT FUNCTION: Used to dewater scrubber waste.

Nearest Downstream Town: Name Elmendorf, TX
Distance from the impoundment 4.5 miles
Impoundment Location: Longitude 98 Degrees 18 Minutes 53 Seconds
Latitude 29 Degrees 19 Minutes 27 Seconds
State TX County Bexar

Does a state agency regulate this impoundment? YES [x] NO

If So Which State Agency? Texas Commission on Environmental Quality

HAZARD POTENTIAL (In the event the impoundment should fail, the following would occur):

_____ **LESS THAN LOW HAZARD POTENTIAL:** Failure or misoperation of the dam results in no probable loss of human life or economic or environmental losses.

 X **LOW HAZARD POTENTIAL:** Dams assigned the low hazard potential classification are those where failure or misoperation results in no probable loss of human life and low economic and/or environmental losses. Losses are principally limited to the owner's property.

_____ **SIGNIFICANT HAZARD POTENTIAL:** Dams assigned the significant hazard potential classification are those dams where failure or misoperation results in no probable loss of human life but can cause economic loss, environmental damage, disruption of lifeline facilities, or can impact other concerns. Significant hazard potential classification dams are often located in predominantly rural or agricultural areas but could be located in areas with population and significant infrastructure.

_____ **HIGH HAZARD POTENTIAL:** Dams assigned the high hazard potential classification are those where failure or misoperation will probably cause loss of human life.

DESCRIBE REASONING FOR HAZARD RATING CHOSEN:

Failure or misoperation of the impoundment would likely result in damage to CPS property. Liquids would flow into Calaveras Lake which was constructed by and is owned by CPS Energy.

CONFIGURATION:

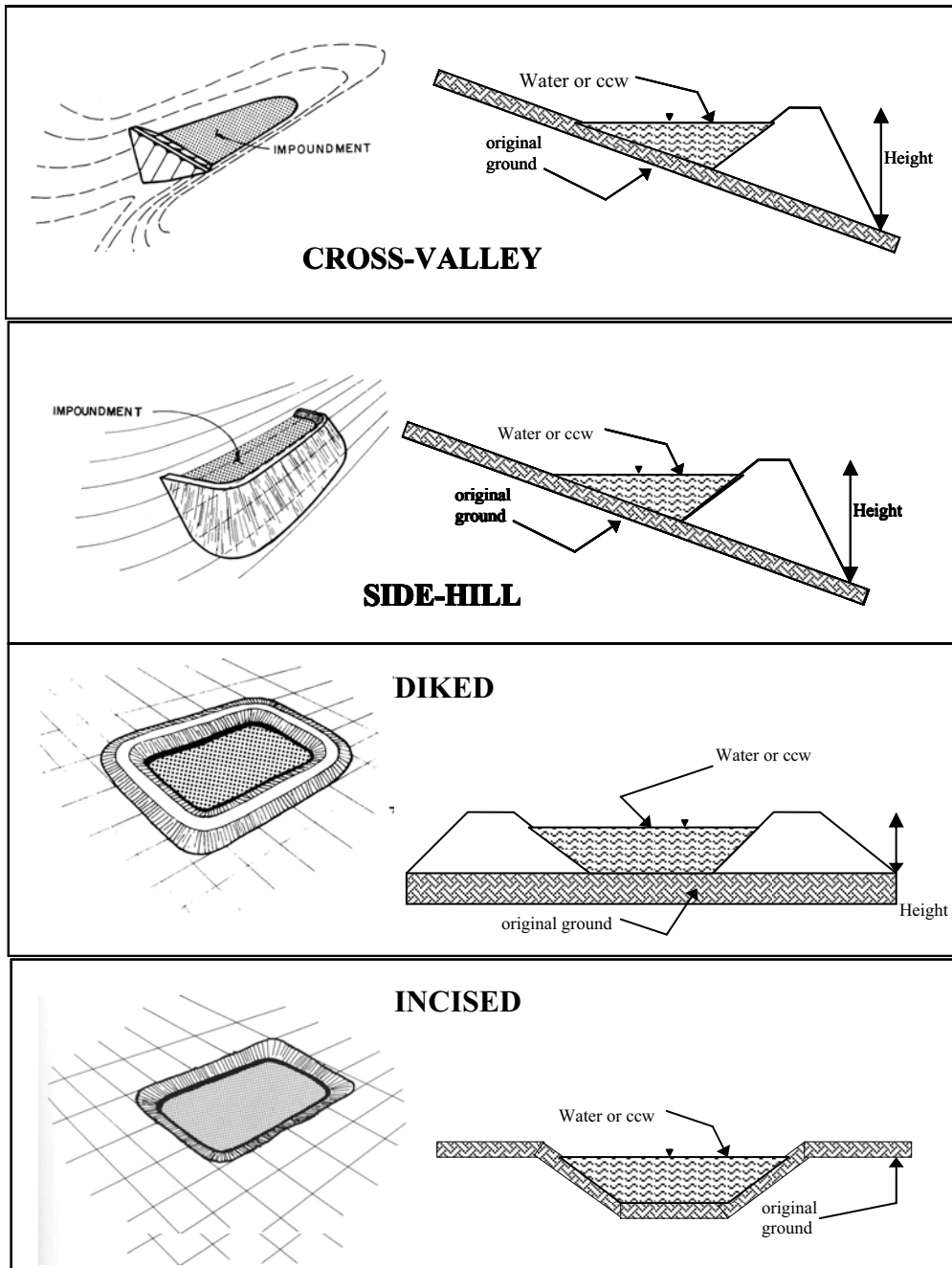

- Cross-Valley
- Side-Hill
- Diked
- Incised (form completion optional)
- Combination Incised/Diked

Embankment Height 15* feet Embankment Material unknown

Pool Area 4.5 acres Liner PVC

Current Freeboard 2* feet Liner Permeability unknown

*Because information was not provided on this pond, embankment height and current freeboard were estimated during the assessment.

TYPE OF OUTLET (Mark all that apply)

 Open Channel Spillway

- Trapezoidal
- Triangular
- Rectangular
- Irregular

- depth
- bottom (or average) width
- top width

TRAPEZOIDAL

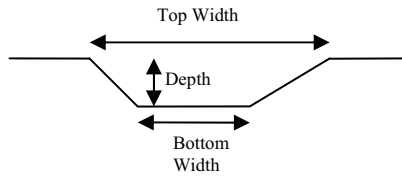

TRIANGULAR

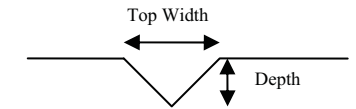

RECTANGULAR

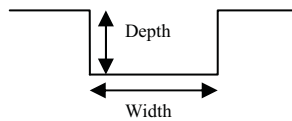

IRREGULAR

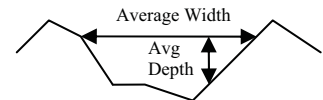

 Outlet

 inside diameter

Material

- corrugated metal
- welded steel
- concrete
- plastic (hdpe, pvc, etc.)
- other (specify) _____

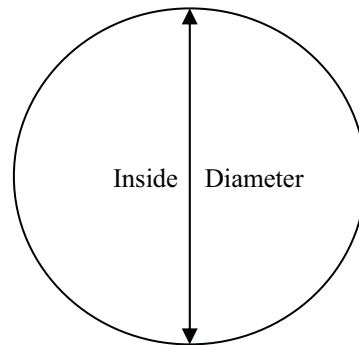

Is water flowing through the outlet? YES _____ NO _____

 X **No Outlet**

 Other Type of Outlet (specify) _____

The Impoundment was Designed By unknown

Has there ever been a failure at this site? YES _____ NO X _____

If So When? _____

If So Please Describe : _____



ADDITIONAL INSPECTION QUESTIONS

Concerning the embankment foundation, was the embankment construction built over wet ash, slag, or other unsuitable materials? If there is no information just note that.

The Evaporation Pond embankments were constructed on top of an area that had previously been used as a fly ash landfill and as a fly ash impoundment. Boring logs for subsurface investigations performed at the Evaporation Pond in 2012 by Raba Kistner Consultants, Inc., did not encounter CCW or other unsuitable materials per project boring logs.

Did the dam assessor meet with, or have documentation from, the design Engineer-of-Record concerning the foundation preparation?

The assessor did not meet with, or have documentation from, the design Engineer of Record concerning foundation preparation.

From the site visit or from photographic documentation, was there evidence of prior releases, failures, or patchwork on the dikes?

There was no indication of prior releases, failures or patchwork on the embankments.

Appendix C
Documentation from CPS

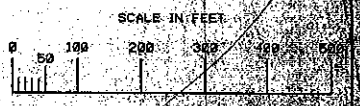
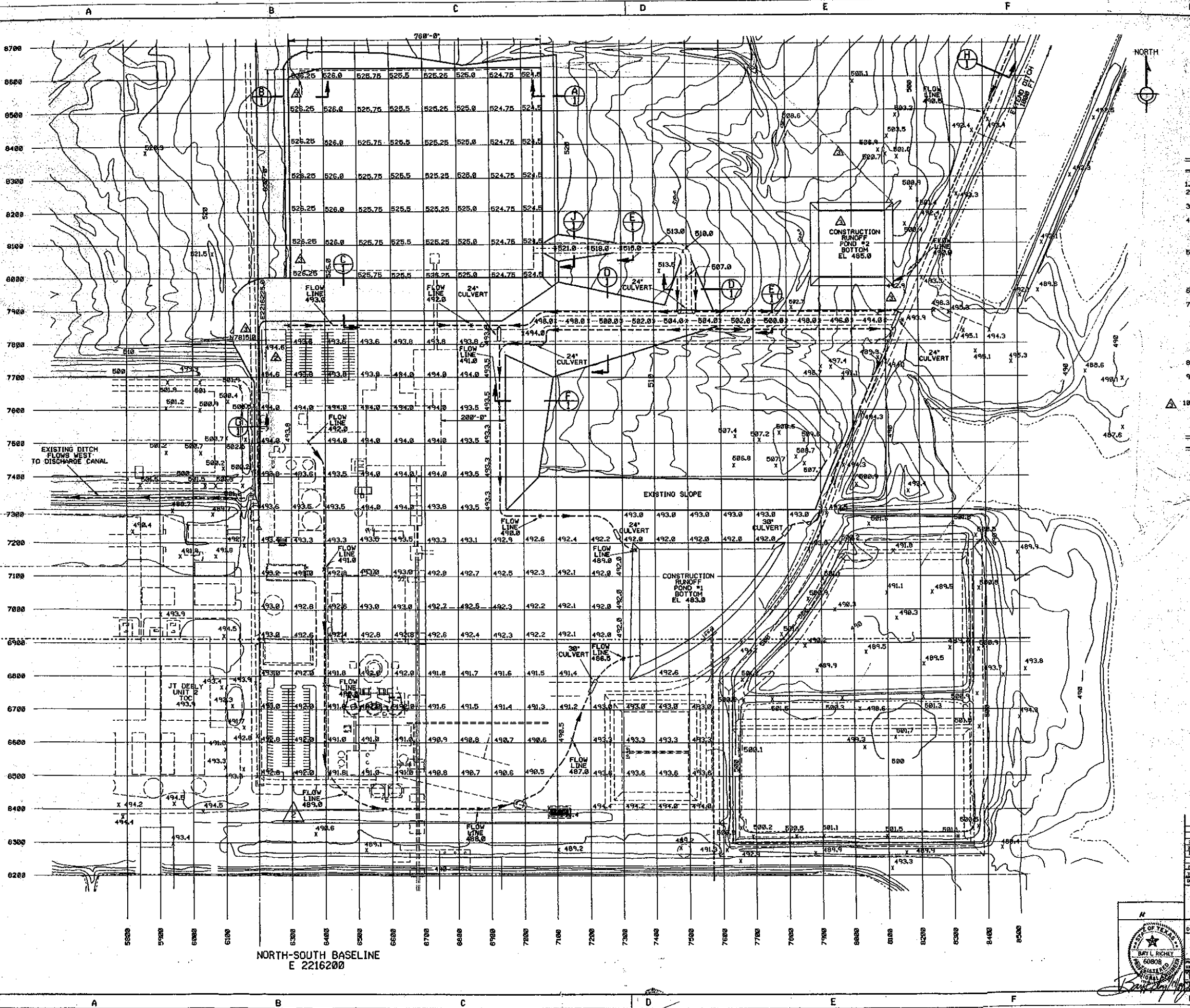

GENERAL NOTES

1. PLANT ELEVATION 100 FT = 40' PER INCH
2. ALL SITE FILL SHALL BE CONTROLLED AND COMPACTED FILL
3. --- INDICATES A DITCH AND DIRECTION OF FLOW
4. DITCHES SHALL BE CONSTRUCTED TO A MINIMUM SLOPE BETWEEN FLOW LINE OBSERVATIONS INDICATED. CONTRACTOR SHALL MAINTAIN ALL DITCHES DRAIN THROUGHOUT CONSTRUCTION RUNOFF PONDS.
5. CONTRACTOR SHALL INSURE THAT THE COURSE OF CONSTRUCTION ALONG SUBWAY RUNOFF FROM AREAS WITH DISTURBED SOILS TEMPORARY FACILITIES, LAYDOWN AND CONSTRUCTION SHALL DRAIN INTO ONE OF THE TWO CONSTRUCTION RUNOFF PONDS.
6. GRADES GIVEN ARE TOP OF FINISHED CONSTRUCTION SUBGRADE
7. TOP OF SLAB ELEVATIONS FOR MAJOR STRUCTURES OF UNIT 1) SHALL BE:
 OFFICE BUILDING 499.0
 TURBINE BUILDING 498.0
 MAINTENANCE BUILDING 497.0
 BOILER BUILDING 496.0
 BAGHOUSE 495.0
 SCRUBBER 494.0
 AGCS BUILDING 493.0
8. CULVERTS SHALL BE REINFORCED CONCRETE PIPE CLASS III DESIGN
9. SOILS EXCAVATED FROM THIS AREA SHALL BE USED AS FILL OR STOCKPILED FOR USE AS FILL IF IT IS FREE OF LARGE ROCKS, DRIFT MATERIALS OR DEBRIS
10. TOP OF CONCRETE SLAB FOR MAJOR STRUCTURES TO BE AT ELEV. 495.0

REFERENCE DRAWINGS

1. SECTIONS AND DETAILS
 D-CL05-006-8005
2. CONSTRUCTION RUNOFF POND
 D-CL05-158-5001

RECEIVED
 APR 14 1994
 POWER

**AS
 CONSTRUCTED**

CITY PUBLIC SERVICE J. K. SPRUCE UNIT 1	
UTILITY ENGINEERING & CONSTRUCTION ENGINEERING, INC.	
SITE PREPARATION CONSTRUCTION GRADS	
DATE: 03-21-94 DRAWN BY: MICHELL	PROJECT: J.K. SPRUCE UNIT 1 SHEET: D-CL05-006-8005

EAST-WEST BASELINE
 N 536915

NORTH-SOUTH BASELINE
 E 2216200

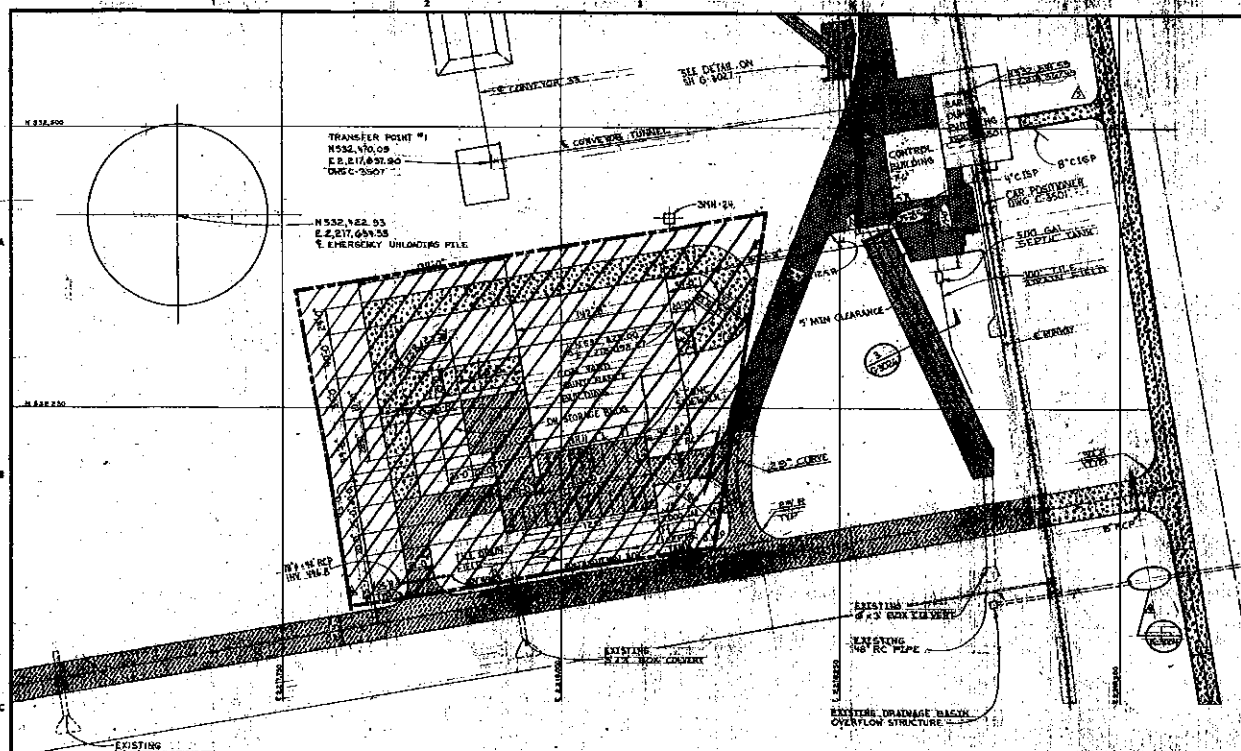

GOAL HANDLING SERVICE AREA
SCALE: 1"=50'

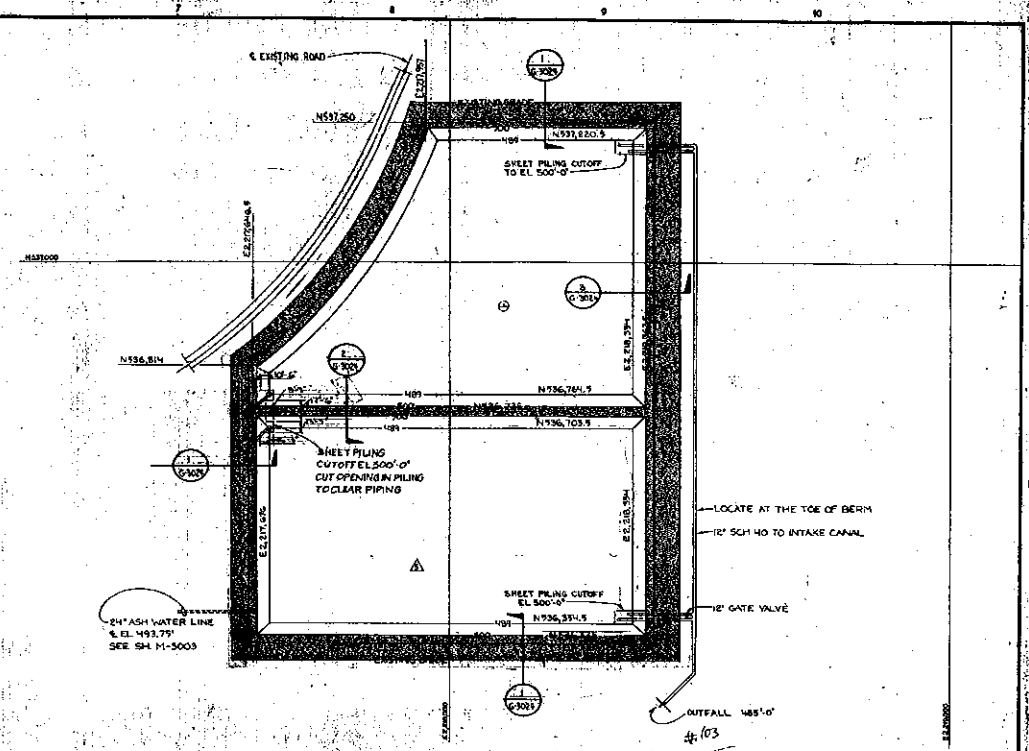

ASH DISPOSAL BASINS
SCALE: 1"=10'

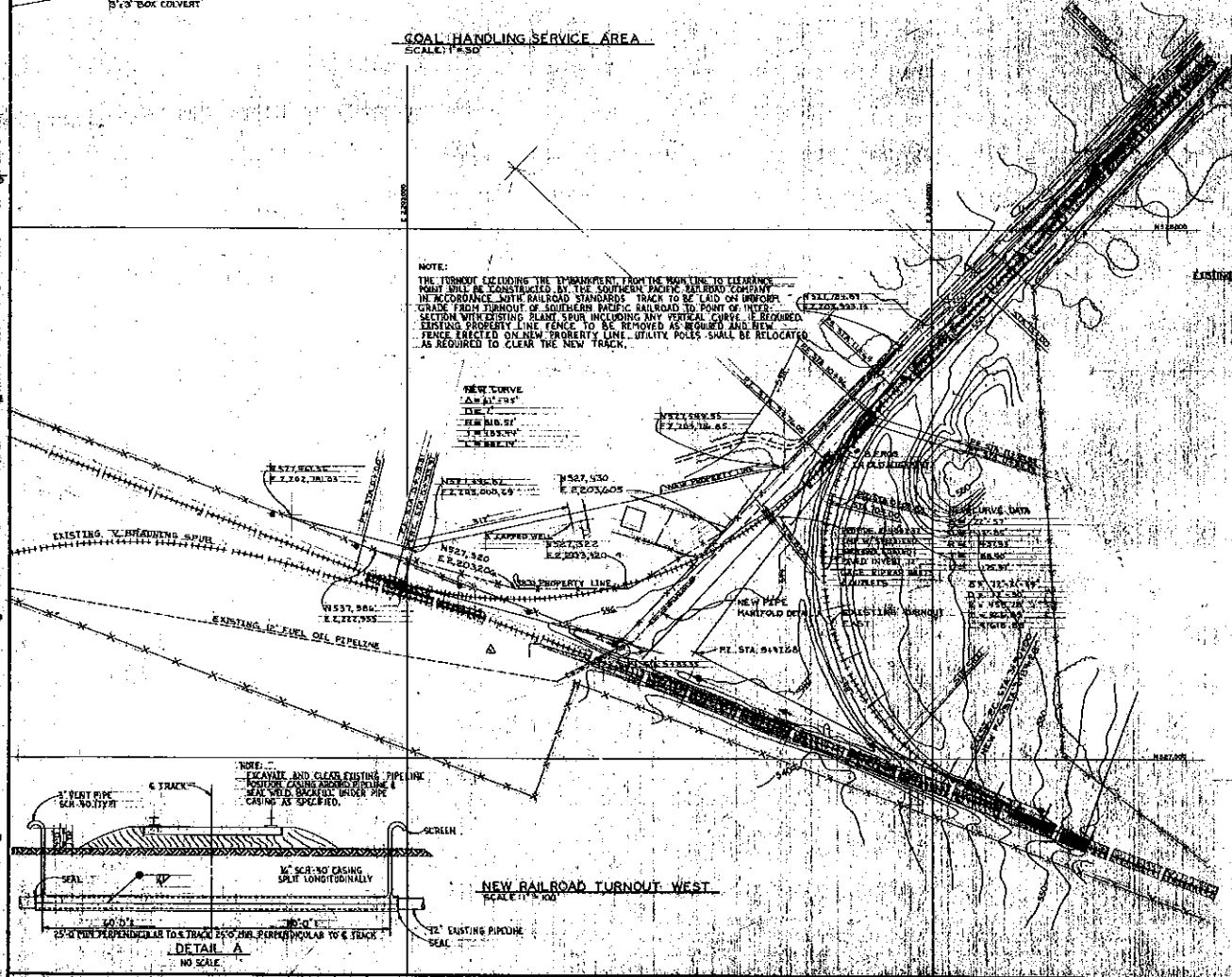

NEW RAILROAD TURNOUT WEST
SCALE: 1"=50'

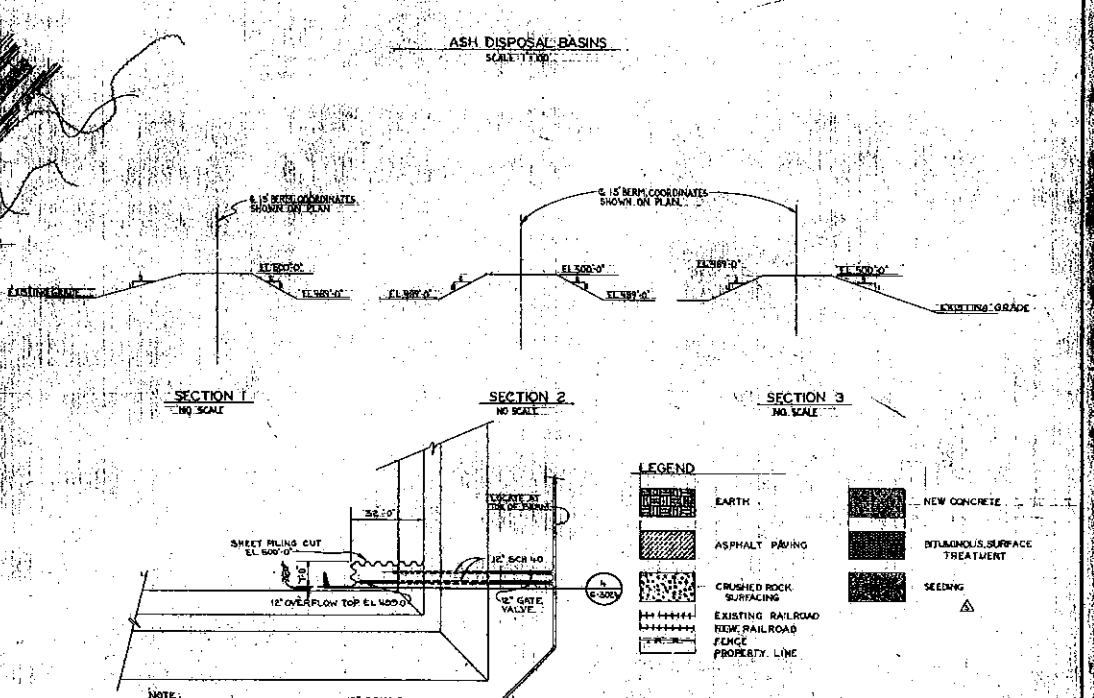

SECTION 1
NO SCALE

SECTION 2
NO SCALE

SECTION 3
NO SCALE

LEGEND

[Hatched pattern]	EARTH	[Solid black]	NEW CONCRETE
[Diagonal lines]	ASPHALT PAVING	[Dotted pattern]	DIFFERENTIAL SURFACE TREATMENT
[Cross-hatched pattern]	CRUSHED ROCK SURFACING	[Stippled pattern]	SEEDING
[Dashed line]	EXISTING RAILROAD FENCE, RAILROAD FENCE, PROPERTY LINE	[Triangle symbol]	

GENERAL NOTES

REFERENCE DRAWINGS

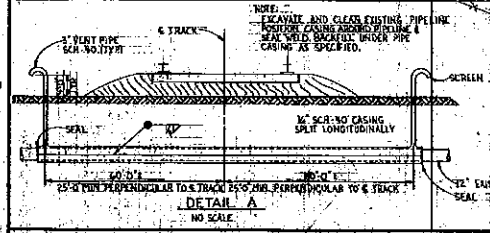

DETAIL A
NO SCALE

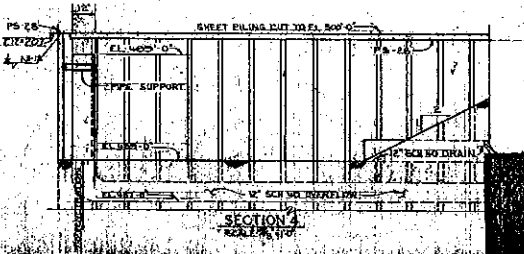

SECTION 4
SCALE: 1"=10'

DATE	DESCRIPTION	BY	CHECKED

CITY OF DENVER, COLORADO

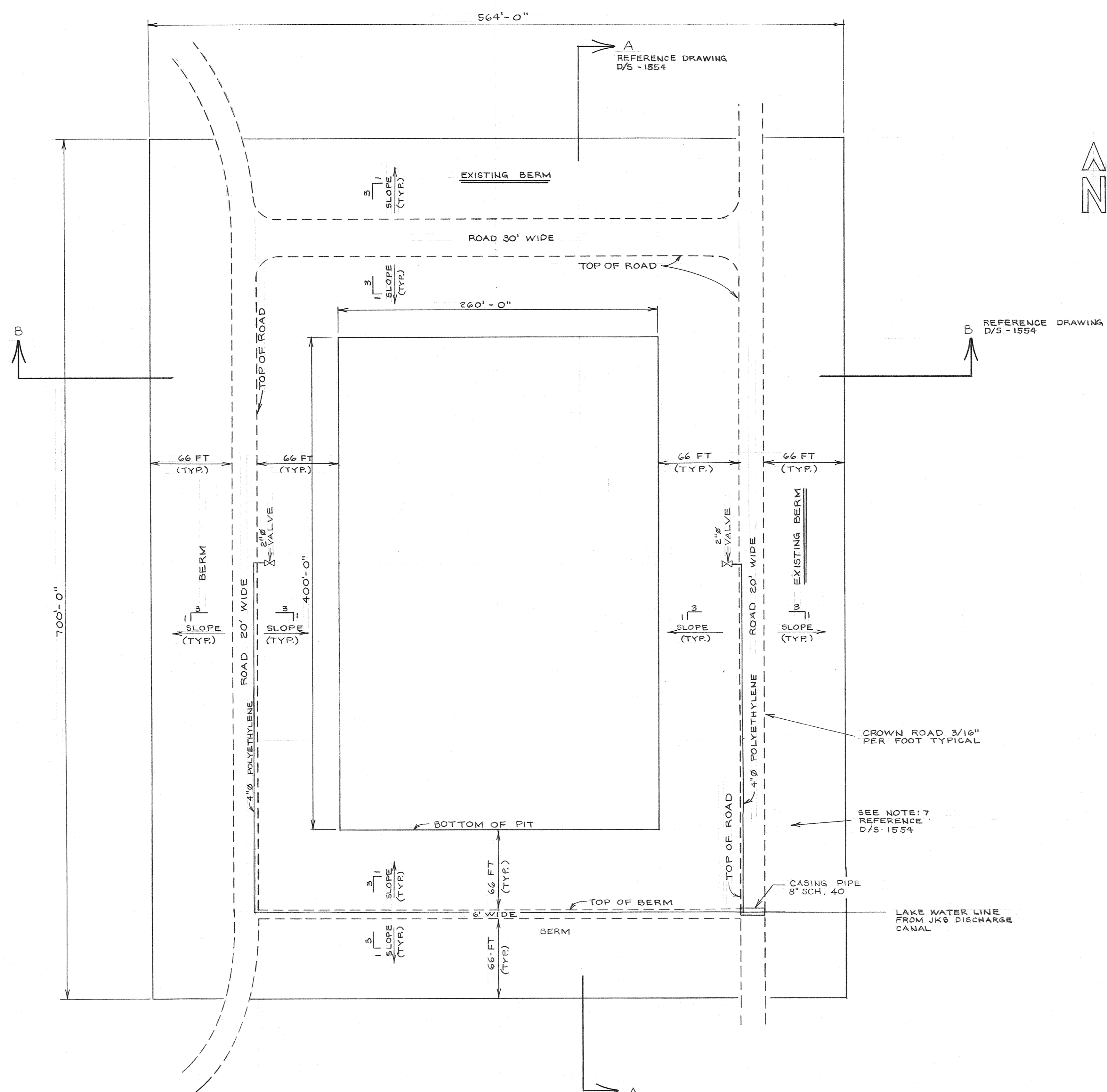

- REFERENCE DRAWINGS
 1. D-CLOS-289-S002
 2. D/S 1554

CROWN ROAD 3/16" PER FOOT TYPICAL
 SEE NOTE: 7 REFERENCE D/S-1554

CASING PIPE 2" SCH. 40
 LAKE WATER LINE FROM JKB DISCHARGE CANAL

J.T. DEELY/J.K. SPRUCE
 ASH DISPOSAL PIT # 4
 PLAN VIEW

CITY PUBLIC SERVICE
 SAN ANTONIO, TEXAS

DRAWN: FRANK TOBAR DATE: 7/16/90
 CHECKED: DTS SCALE: 1" = 50'-0"
 APPROVED: DTS SHEET 1 OF 1

No.	DATE	REVISION	BY	CK'D	APP	SYSTEM	I.D.	DRAWING NUMBER	CODE
1	7-25-90	BID ISSUE	FT.	DEE	DTS			D/S - 1547	

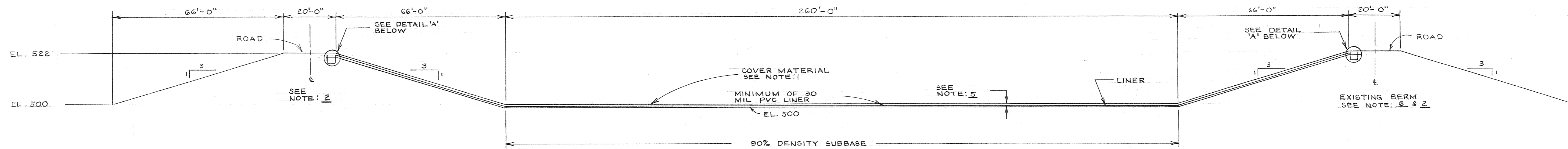

SECTION 'B-B'
— LOOKING NORTH —
SCALE: 1" = 20'-0"

REFERENCE DRAWINGS
1. D-CLOS-289-S002
2. D/S-1547

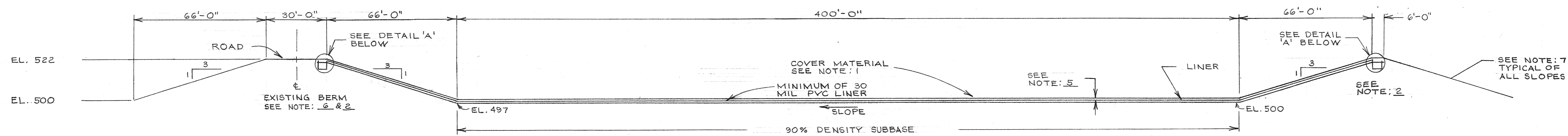

SECTION 'A-A'
— LOOKING EAST —
SCALE: 1" = 30'-0"

- NOTE:
- COVER MATERIAL SHALL BE COHESIVE SOILS FREE OF ALL ROCKS, ROOTS AND OTHER FOREIGN MATERIALS. THE COVER MATERIALS SHALL BE PLACED OVER THE LINER AS RECOMMENDED BY THE MANUFACTURER AND APPROVED BY CPS FIELD REPRESENTATIVE.
 - SUBGRADE COMPACTED TO 90% DENSITY
 - ROCKS THAT ARE LESS THAN 6" X 12" ARE ACCEPTABLE IN ALL BUT THE TOP TWO FEET OF THE BERM.
 - CONTRACTOR WILL BE REQUIRED TO WATER ALL EXTERNAL SLOPES FOR A PERIOD OF TWO MONTHS (DAILY) TO AID IN THE ESTABLISHMENT OF GRASS
 - REQUIREMENTS FOR SOIL COVER MATERIAL
 - PVC - 1 FT. OF THE TYPE OF SOIL STATED IN NOTE #1
 - HDPE - 4 IN. OF THE TYPE OF SOIL STATED IN NOTE #1
 - MOST OF THIS BERM IS EXISTING. THE CONTRACTOR WILL BE REQUIRED TO COMPLETE THE INSIDE SLOPES AND TO BRING THE EXISTING ROAD UP TO ELEVATION 522.
 - MIRAMAT "2400" OR TENSAR "NS3000" EROSION CONTROL AND REVEGETATION MAT SHALL BE INSTALLED ON EXTERNAL SLOPES, PER MANUFACTURE RECOMMENDATION. EROSION CONTROL MAT IS TO BE SUPPLIED AND INSTALLED BY CONTRACTOR. MAT IS TO BE COVER WITH A MINIMUM OF 1" OF TOP SOIL. ALL EXTERNAL SLOPES SHALL THEN BE SEED, FERTILIZED AND MULCHED BY CONTRACTOR PER SPECIFICATIONS.

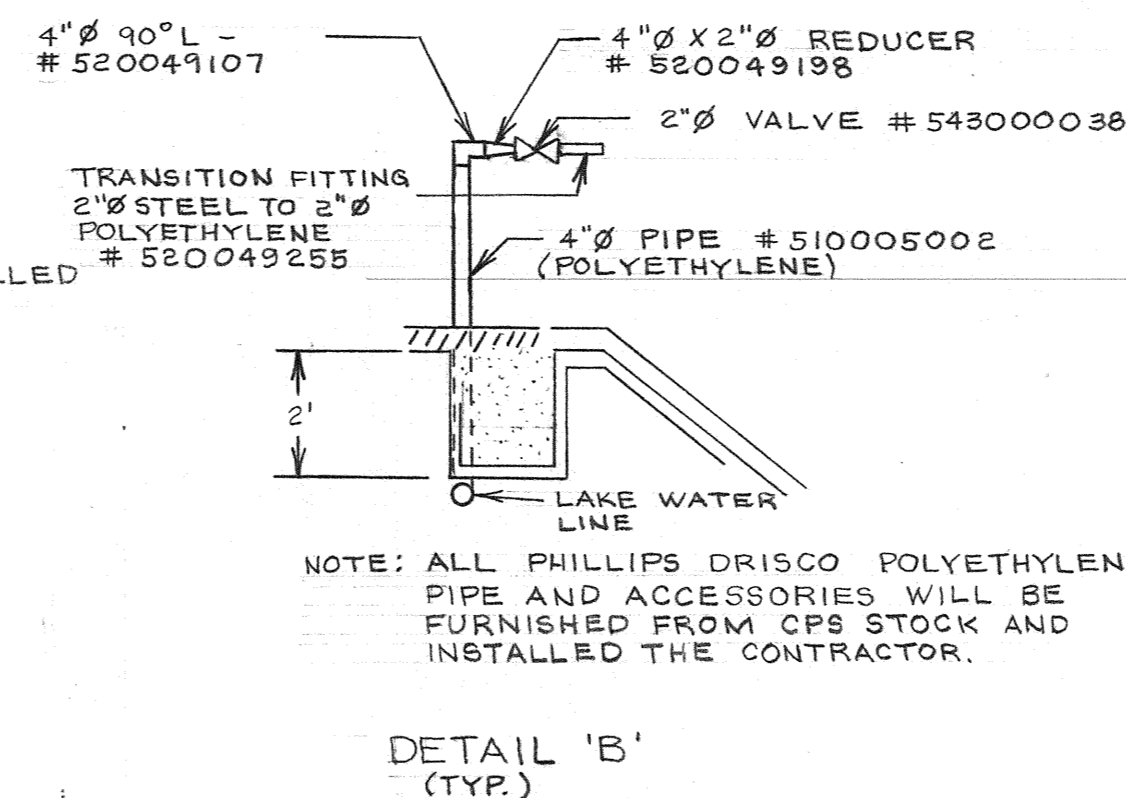
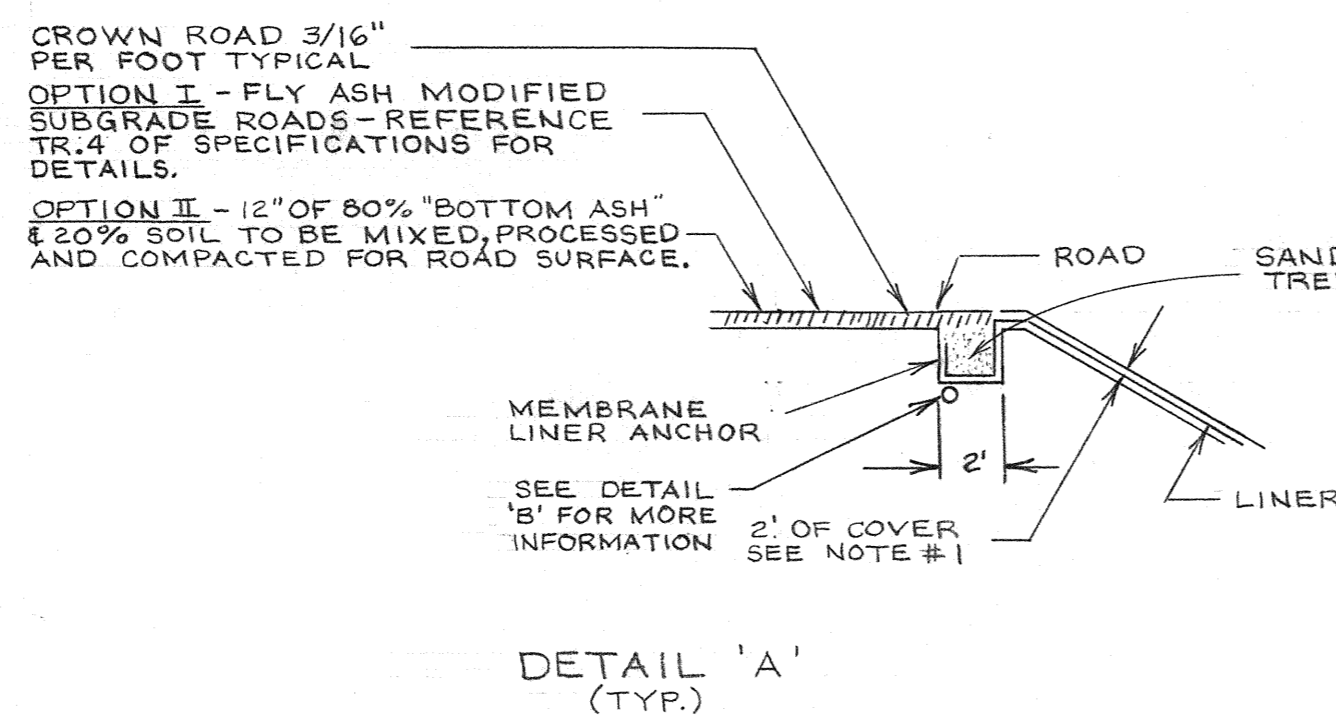

J.T. DEELY / J.K. SPRUCE
ASH DISPOSAL PIT # 4
ELEVATION VIEWS

CITY PUBLIC SERVICE
SAN ANTONIO, TEXAS

DRAWN: FRANK TOBAR	DATE: 7/16/90
CHECKED: DTS	SCALE: SHOWN
APPROVED: DTS	SHEET 1 OF 1
SYSTEM	I.D.
NO.	DATE
REVISION	BY
CK'D	APP
DRAWING NUMBER	CODE
D/S - 1554	

1	7-25-90	BID ISSUE	FT.	DTS	DTS	SYSTEM	I.D.	DRAWING NUMBER	CODE
No.	DATE	REVISION	BY	CK'D	APP			D/S - 1554	

34

Day

8/16/12

Munoz

0700 START 3B AWP / 3Cick and Puroci

0800 SECURE 3B AWP

A BROWN STEEL CIRCUMFERED ON 24" PIPING

1400 START 3B AWP / START 3A & 4A BAS

1530 Cap 3A & 4A BAS / START Puroci

POSD +5' / 24" PIPING - CLOSED OSTS (FOR CHECKING)

ECON HAPPENS; DANG STAIRS - OK

ADDED HO TO CS & CY @ OSTS

REMOVED AMERICAN TRUCK

CIRCUMFERED 24" PIPING

WATER USAGE ON CS & CY

STARTED DEELY DIESEL FIRE TRIP FIRE COME YARD WALK / BACK IN AUTO

FIRE AND COME PIPES ON ED BELOW 4th FLOOR GRADING HD CORNER

SEMI AIR FEUSTER FAN^{WCC} AND CS - 3C INCC SHUTTER OUT (BREW UP)

EMPTYED PLATE APPR - 4C

NIGHT

9-15-12

MEBLAIN

2100 START 3A+4A BAS
2230 COMP 3A+4A BAS S/P
2350 START 3C+4C BAS
0100 COMP 3C+4C BAS S/P
0230 SHUT DOWN BAS / SECURED 3A-AWP

- POND - 15 24" - OPEN
- ECON HOPPERS + DRAG CHAIN - OK
- T1 - 1' 4 1/4" / T2 - 7' 7 1/4"
- RAN TRAVELING SCREENS
- DRAINED C3 VALVUM PAVING
- CLEANED 3B, 4C, 4D PYBITES

0900 Start 3E & 4E Bas

0900 Comp 3E & 4E Bas / Start Purge

1130 Start 3B & 4A Bas

1300 Comp 3B & 4A Bas / Start Purge

1400 Start 3D & 4A Bas

* Electricians Replaced Solenoid on 4A Bas Gate

1530 Comp 3D & 4A Bas / Start Purge

* Have Bottom Ash Complete by 0900 so 21" Return
Can be Churned

Flow - 14" / 24" Return - 0900

• Empty Hoppers & Drag Chain - OK

• Added H₂O to C4 @ 0915

• Run Through Screens

• Picked Down C3 & C4 yard Return Pits

• Electricians Replaced #1 Bas Gate Solenoid

• Empty Purge Hoppers - C1 & 4A

• Replaced Motor Air Filters - 3A mill, 3C mill, 3A PA Fan,

3A SBAC

• Swapped 3B mill Lube Oil Filters

* 3B Transport Blower 1/5 low oil level - (Lub)

* 4B Rev Gas Fan 1/5 low oil level - (Lub)

* 3B SBAC Purge 1 Pump 1/5 low oil level - (Lub)

* 3A SBAC Start 3 Trap Bypass 1/5 low oil level - (Lub)

Night 8-14-12

GRASS

31

1900 Start 3B & 4A BAS (could not get 4B gate open)

2020 Comp. 3B & 4A

2035 Begin purges

2135 Start 3D & 4D BAS

2250 Comp. 3D & 4D

2310 Begin purges

0100 Comp. purges

0300 Start 3A & 4A BAS

0410 Comp 3A & 4A

0425 Begin purges

Pond +5" (24" return drain still open)

- Shutdown 4A SBAC, started 3B SBAC

- Drained C3 vac priming suet. tank

- purities cleaned: 4D 3A

- T1 1'4 $\frac{1}{4}$ " T2 7'7 $\frac{3}{8}$ "

- C3 & C4 Econo hoppers and drag chains OK

- 4D A/W conv. solenoid is malfunctioning, had to override to get the gate closed (W/W)

- C3 & C4 put travelling screens back to auto

Loto)

rounds

30

DAY

8/14/12

GRAVES

05:30 purging 3D + 4D BAS
07:00 shutdown BAS
18:00 started 3A + 4A BAS
19:00 purging 3A + 4A BAS
16:00 started 3C + 4C BAS

- TRAVELING SCREENS ON C3 + C4
- cleaned 3D Pyrite hopper
- started 4A SBAC, shutdown 3B (on Loto)
- * - CH seal trough make-up valves at 1/2 rounds
open as per D. Martinez.
- cleaned 3C + 4A pyrite hoppers

JES

NIGHT

8-13-12

M^cBLAIN

29

1730 START 3A-AWP FOR T+E

1900 START 3A+4A BAS

2020 COMP 3A+4A BAS S/P

2125 START 3C+4C BAS

2240 COMP 3C+4C BAS S/P

0200 START 3B+4A BAS

0300 COMP 3B+4A BAS S/P

0420 START 3D+4D BAS

- POND - +1 24" RETURN DRAIN - OPEN

- ECON HOPPERS + DRAG CHAIN - OK

- RAN TRAVELING SCREENS

- ADDED GAS C3+C4 @ 1940

- DRAINED C3 VACUUM PRIMING

- T1 - Ø 1' 4 1/4" / T2 - 7' 7 1/4"

- CLEANED 3E, 4D + 4E PYRITES

WVO 4C - DIAPHRAGM BLOWN

28

Day

5/13/12

Graves

05:20 Started 3C and 4C BAS

06:30 Purging 3C and 4C BAS

07:30 Shutdown BAS

11:00 Started 3A Ash water pump

11:00 Started 3B + 4B BAS

12:30 Purging 3B + 4B BAS

13:30 Started 3D + 4D BAS

Pond #1

Cleaned 4D + 4C pyrite hoppers

SON

NIGHT

5/12/12

MUNOZ

27

1900 START 3A & 4A GAS / START 3B AWP

2040 Comp 3B & 4A GAS / START PUMPS

2200 START 3A & 4A GAS

2300 Comp 3A & 4A GAS / START PUMPS

0230 START 3A & 4A GAS

0400 Comp 3A & 4A GAS / START PUMPS

3EM.1)

Fan,

if

Pumps - +1" / 24" Review - spec

Event happens & Dens curve - ok

T1 - 1'4" / T2 - 3'7" / 4"

Transmits success in Auto

Stopped oil filters on 3B mill

checked Densit happens - 3A & 4A

SWIFT TURBINE PUMP

Is 3B mill

MS

* STOP OIL FILTER ON 3B MILL DIRTY - (WWD)

26

Day

8-12-12

Lawson

0530 start 3D & 4D BAS

0710 comp 3D & 4D SP

1100 start 3A & 4A BAS

1200 comp 3A & 4A SP

1300 start 3C & 4C BAS

1400 comp 3C & 4C SP

1500 purge complete shut down 3A Awp

cleaned pyrites C4 4A, 4B, 4C, 4D

Changed Air filters (3): 3A M.11, 3B M.11, 3E M.11

② 3A PA Fan 3A & 3B FD Fan

C1 & 4B, 4C, 4D, 4E Mills, 4B PA Fan,
4B FD Fan② Picked up others dirty filters left
laying around.

STAINING OF CRACKS

Asp Pond + 2

T1 1' 4 3/6"

T2 7' 7 1/4"

4
2

HM

Align

8/11/12

Munoz

- 1900 Start 3A i 4A BAS
- 2100 Cap 3A i 4A BAS / Start Purge
- 2240 Start 3C i 4C BAS
- 2350 Cap 3C i 4C BAS / Start Purge
- 0300 Start 3B i 4B BAS
- 0415 Cap 3B i 4B BAS / Start Purge

Point - +1" / 24" Return - OPEN

Even Hoppers & Drag Chain - OK

T1 - 1'4" / T2 - 2'7" / 4"

CO Low's

- Empty 40 Pumps

HIGH DIFF.

24

DAY

08/11/2012

BOEHM

0600 START 3C & 4C BAS

0800 COMP 3C & 4C BAS / START PURGE

1200 START 3B & 4B BAS

1345 COMP 3B & 4B BAS / START PURGE

1445 START 3D & 4D BAS

COMP 3D & 4D BAS / START PURGE

SECURED AWP

CLEANED 4C & 4D PYRITE HOPPERS

RAN ALL TRAVELING WATER SCREENS DUE TO HIGH DIFF.

DRAINED C3 VAC. PRIMING TANK

COMPOUND CHEMICALS @ 1200

POND @ +2"

Alger

8/10/12

Munoz

1900 Start 3B i 4A Bas

2040 Emp 3B i 4A Bas / Start Puzos

2200 Start 3B i 4A Bas

2310 Emp 3B i 4A Bas / Start Puzos

0200 Start 3A i 4A Bas

0330 Emp 3A i 4A Bas / Start Puzos

Peak +1' | 24" diameter

T1- 1'4" | T2- 7'7"4"

5 TURNS

Empty Hoppers & Drag Chain etc

Drum on 3 Via Prime Trade

Empty Pyrite Hoppers - 4c i 4A

22

PAY

8-10-12

M^oBLAIN

0730 CONTINUOUS PULL C3 BAS FOR WASH

1200 START 4A BAS

1310 COMP 4A BAS S/P

1435 START 4C BAS

1550 COMP 4C BAS S/P

- POND #1 24" - OPEN

- ECONOMIZER DRAG CHAIN + HOPPERS - OK

- RAN TRAVELING SCREENS

- SLUCE GATE CLOSED ON C3 YARD DRAIN

- YARD DRAIN PIT PUMPED DOWN + WASHED SLUCE GATE 5 TURNS

- CLEANED 4D PYRITES

Munoz

8/9/12

Munoz

1750 Start 3c i 4c Bas

2010 Camp 3c i 4c Bas / Start Purge

2340 Start 3B i 4A Bas

* Drawn 4c analyze computer Trade to 1/2 way

0130 Camp 3B i 4A Bas / Start Purge

0230 Start 3A i 4A Bas

0340 Camp 3A i 4A Bas / Start Purge

- Pond Level 124" Return - Open

- T1 - 14'14" / T2 - 37'14"

- Empty Hoppers i Dragg Chain - OK

- Drawn C3 Vac Purge Trade

- Raw Tanking Success

- Put Assessment on East Side of Col Hardware (Pickle Area)

- Empty Purge Hoppers - 4c i 4D

* Col Purge Purge Pump - (Low)

* 3A i 3B Lube oil Temp Hi @ 152°F (Alarm Point @ 150°F)

* 3A i 3B Low VSD Alarm - Current Temp Hi

20

DAY

8-9-12

MEBLAIN

1120 START 3A-AWP / START PURGE ON C3 CROSSOVER TO C4

1230 STOP PURGE (ELECTRICAL WORKING ON SEQ XV-357)

1410 START 3A+4A BAS

1630 COMP 3A+4A BAS S/P

- POND - EVEN 24" OPEN

- RECEIVED AMMONIA TRUCK

- ECON HOPPERS + DRAG CHAIN - OK

- RAN TRAVELING SCREENS

- CLEANED 4C+D PYRITES

- changed 3A, 3E mill ~~to~~ motor filters

- changed 3B PA fan motor filters

- changed 3A SBAC motor filters

- changed 3B AWP motor filters

- CLEANED 4D PYRITES AGAIN

4
2

NIGHT

8/8/12

HIGGINS 19

1730 START 3A/4A PURGE

1830 PURGE COMPLETE / START 3C/4C BAS

CROSSOVER

2200 3C/4C PURGE COMPLETE / SHUTDOWN BAS

2205 STOPPED ~~3B~~ AWP

0300 ~~START 3B AWP / START 3B/4A BAS~~ (SEE NOTE BELOW)

* PAND #4

* T1 - 1'4³/₁₆" T2 - 7'7⁵/₁₆"

* CLEANED 4D PIPE 2 TIMES

* CROSSOVER VALVES 357 AND 358 OPENED WHILE BAS WAS OFF CAUSING IT TO LOSE PERMITS TO RESTART. THE 0300 PULL IS POSTPONED UNTIL CRAFTS CAN RESTORE PROPER VALVE OPERATION

18

DAY

8-8-12

M³BLAIN

0540 LOST C3 BAS PERMIT

0600 CONTINUOUS PULL C4

0800 SHUT DOWN BAS / SECURED 30-AWP (ELET. WORKING ON CROSSOVER)

1440 START 30-AWP / START 3A+4A BAS

- POND - +3 24" - OPEN @ 0950

- ECON HOPPER + DRAG CHAIN - OK

- CLEANED 3A+4A PYRITES

- ALL TRANSPORT & FLUIDIZING BLOWERS BACK IN SERVICE

S

Night

8-7-12

Lawson/Graves¹⁷

1733 3A AWP on
 1833 3A AWP off
 1850 3B AWP on
 1920 start 3A & 4A BAS
 2140 comp 3A & 4A SP
 2230 start 3C & 4D BAS
 0100 comp 3C & 4D BAS
 0200 start 3B & 4A BAS
 0300 comp 3B & 4A SP
 0400 start 3D & 4D BAS
 0445 comp 3D SP

changed filters: C3 3A Bowl M.11, 3B AWP
 C4 4A Bowl M.11

WWD: C3 3C clinker grinder will not stay running
 C4 BAS crossover VLV #357 limits needs reset.

for
 cleaned Pyrite Hoppers: C3 3A, 3B, 3E, 3A again
 C4 4C, 4D

T-1 1' 4³/₁₆" T-2 7' 7⁵/₁₆"

Pond + 1

p

c

16

Day

8-7-12

Brooks

Pond -3

- AWP Cell is going empty waiting for someone to look at the issue
- Deisolated 3A Mill
- Deisolated 3 vac. prime system
- Electrician fixed C4 Pentax Recirc. pump
- Got a load of Ammonia
- Got a load of Nitrogen
- cleaned 3C pyrite
- vac. priming crossover vlv. still open and on loto.

8-6-10

Night

Lawson

15

~~Start 3AWP, start 3B & 4A BAS~~

~~Comp 3B & 4A SP~~

~~start 3D & 4D BAS~~

~~Comp 3D & 4D SP~~

~~Comp purge shut down 3A AWP~~

~~start 3BAWP, start 3A & 4A BAS~~

~~Comp 3A & 4A SP~~

AWP Cell Level indicator not working
could not pull BAS LWO.

Ashpond Even

Changed filters C3 3B SPAC

Cleaned 3D & 4D pyrite hoppers

14

5:45 shut down BAS

12:00 start 3B AWP

start 3A & 4A BAS

1:00 purge 3A & 4A BAS

2:00 start 3C & 4C BAS

2:45 purge 3C & 4C BAS

3:55 shut down BAS

pond +2

GMS fixed 3D diaphragm
cleaned 4C pyrite
changed fitters on 4B PA

-V 554

NIGHT

8-5-12

MSBLAIN

13

1900 START 3A+4A BAS
2010 COMP 3A+4A BAS S/P
2200 START 3C+4C BAS
2320 COMP 3C+4C BAS S/P
0045 START 3B+4A BAS
0200 COMP 3B+4A BAS S/P
0320 START 3C+4D BAS
0415 COMP 3C+4D BAS S/P

- POND - +2 24" - OPEN
- ECON HOPPERS + DRAGCHAIN - OK
- T1 - 1'4 1/4" / T2 - 7'7 1/4"
- RAN TRAVELING SCREENS
- CLEANED 3A PYRITES
- CHANGED MOTOR AIR FILTERS ON 3B-SBAC
- ADDED WATER TO STATOR TANK ON C3-53.8

12

8-5-12

Day

Lyssy

7:00 pull 3C b 4C BAS

8:30 purge 3C b 4C BAS

11:00 start 3B b 4A BAS

12:00 purge 3B b 4A BAS

1:00 start 3D b 4D BAS

2:30 purge 3D b 4D BAS

pond #2

(4) drained vac priming tank
compounded chemicals
cleaned 3A pyrites 4C

NIGHT

8-4-12

M^RBLAIN

1900 START 3A-AWP / START 3B+4A BAS

2030 3A AWP shut off / started 3B

2250 Comp 3B / 4A BAS started purge

2300 START 3C+4D BAS

0020 COMP 3C+4D BAS S/P

0300 START 3A+4A BAS

0400 COMP 3A+4A BAS S/P

- POND #2 24" RETURN DRAIN OPEN

- ECON HOPPERS + DRAG CHAIN - OK

- T1-1'4 1/4" / T2-7'7 1/4"

- RAN TRAVELING SCREENS

- TIED C3 + C4 VACUUM PRIMING (WWO)

- CLEANED 3A 4C+E PYRITES

WWO - 4EQ XV-358 BAS CROSSOVER VALVE LIMIT

WWO - 4B HYDRAZINE PUMP NOT PUMPING

M^RBLAIN

10

Day

8-4-11

Brooks

0630 shut down BAS
1130 start 3B + 4A BAS
1230 3B + 4A comp. S/P
1330 start 3C + 4C BAS
1430 3C + 4C BAS comp S/P
1530 purge comp.
1630 stop AWP

Pond #1

3B Mill has hole in expansion joint
on 1 1/2 floor above pulverizer.

Compounded Chemicals

3

ISON

NIGHT

8-3-12

M^SBLAIN

9

1900 START 3A-AWP / START 3A+4A BAS

2000 LOST POWER TO AWP'S / START 3B-AWP / CONTINUE 3A+4A BAS

2100 COMP 3A+4A BAS S/P

2200 START 3C+4C BAS

2300 COMP 3C+4C BAS S/P

0110 START 3B+4A BAS

0220 COMP 3B+4A BAS S/P

0330 START 3C+4D BAS

0430 COMP 3C+4D BAS S/P

- POND - +2 24" RETURN DRAIN - OPEN
- ECON HOPPERS + DRAG CHAIN - OK
- T1 - 1' 4 1/4" / T2 - 7' 7 1/4"
- DRAINED C3 VACUUM PRIMING

on WWP

8

Day

8-3-12

Lawson

0530 start 3C & 4C BAS

0800 comp 3C & 4C SP

1100 start 3B & 4A BAS

1200 comp 3B & 4A SP

1300 start 3D & 4D BAS

1400 comp 3D & 4D SP

1500 comp purge shutdown 3B AWP

C3 found 3D BAS vent diaphragm blown WWC
 cleaned 4C pyrite hopper
 changed filters 3D bowl mill
 Ash Pond + 3

UCS

NIGHT

8-2-12

M^oBLAIN

7

1730 COMP 3A+4C BAS S/P
 1900 START 3B+4B BAS
 2020 COMP 3B+4B BAS S/P
 2115 START 3D+4D BAS
 2205 COMP 3D+4D BAS S/P
 2345 SHUTDOWN BAS / SECURED 3A-AWP
 0320 START 3B-AWP / START 3A+4A BAS
 0435 COMP 3A+4A BAS S/P

- POND - #1 24" RETURN DRAIN - OPEN

- ECON HOPPERS & DRAG CHAIN - OK

- T1 - 1'4 1/4" / T2 - 7'7 1/4"

- SWAPPED OIL FILTERS ON ^{3B}3B+3D MILLS (WWD)

- CLEANED 3B+D PYRITES

- ADDED H₂ TO C3 & C4 @ 2300

WWD - 3A-SBAC NOT MAINTAINING SET POINT 308 psi 3A @ 250 psi

WWD - 4A TBFP SEAL WATER PUMP STRAINER

WWD - 4B TBFP SEAL WATER PUMP PACKING LEAK

WWD - C4-PANTEX RECIRC PMP

6

DAY

8/2/12

GRAVES

continuous pull on C3

Prod +2 return open
cleaned & 4c pyrite hopper
MA GMS work on 4 B BAS Gate.

4

DAY

8-1-12

GARCIA

Light

0600 Comp 3A/4A Start purge

0645 Start 3C/4C BAS

0715 Comp 3C Start purge

* C4 BAS continuous pull for cascade wash

0945 Start 3A AWP

0950 Secured 3B AWP

1100 Start 3A BAS 3B diaphragm blown/wind

1230 Comp 3A BAS / Start Purge

1330 Start 3D BAS

1430 Comp 3D / Start purge

Placed 3B on purge for GMS

06:00 purge 3B to 4A BAS

08:00 start 3C to 4C BAS

09:00 Purge 3C to 4C BAS

10:00 start 3A to 4A BAS

11:00 Purge 3A to 4A BAS

3:00 start 3A AWP

start 3B to 4A BAS

Pond = +1 24" return drain = open

Deisolated 3A1D Baghouse Comp.

C3 Vacuum priming not ~~starting~~ rising above 11 according to

~~gauge~~ ~~pressure~~ - got vacuum to recover but seal tank activate

Rocked out CEMS Atlas Copco for Mechanics / Complete

Pond +3

economizer drag chains o

cleaned 4C pyrite

T1 1'4 1/4 T2 7'

C4 could not deisolated beer

C4 4C blown diaphragm

Night

8-1-12

Lyssy⁵

6:00 purge 3B to 4A BAS

8:00 start 3C to 4C BAS

9:00 purge 3C to 4C BAS

10:00 start 3A to 4A BAS

11:00 purge 3A to 4A BAS

3:00 start 3A AWP

start 3B to 4A BAS

pond #3

economizer drag chains ok

cleaned 4C pyrite

T1 1'4 1/4 T2 7'7 1/4

working to
bring up
mplate

CU

could not deisolated bearing wtr to 4A CWP vlv stuck

CU

4C blown diaphragm

shut down

Operator Name: (print) R. Wicks
 Supervisor Name: (print) J. C. [unclear]
 Shift: (circle) Day Night Date: 3/26/12

Oil Levels	HI	OK	LOW	HI	OK	LOW	HI	OK	LOW	HI	OK	LOW	HI	OK	LOW	HI	OK	LOW
3A CWP																		
Bearing Wtr Strainer D/P	C3	30	psi	C4	20	psi	Bearing Water Z @ CWP's	C3	0.2	psi	C4	1.5	psi	Yard Drains Pits Outlet Valve # of Turns Open	3A	3B	4A	4B
Run Traveling Screens	3A	Yes	100	3B	Yes	100	Verify Rotation											
Traveling Screen Levels	3A	0.9	ft	3B	0.10	ft												

ID/Fans & Lube Oil Skids	3A	3B	4A	4B
Pump Discharge Z	2.5	psi	4.0	psi
Oil Supply Z	2.5	psi	2.5	psi
Filter D/P	3	psi	2	psi
IB Bearing Flow	11	gpm	11	gpm
OB Bearing Flow	3.75	gpm	4.25	gpm
Discharge Q	130	*F	125	*F
Reservoir Q	130	*F	125	*F
Reservoir Oil Level	HI	OK	LOW	HI
Fan Oil Levels IB/OB Bearings	HI	OK	LOW	HI
Motor Oil Lvs IB/OB Bearings	HI	OK	LOW	HI
ID Fan Stator C's (x6) °C	68	65	68	68
ID Fan IB / OB Bearing C's °C	67	91	67	76
Any VFD Faults Present	Yes	NO	Yes	NO
VFD Coolant Pump Suction Z	3	psi	4	psi
VFD Evaporator Screens Clean	Yes	NO	Yes	NO
VFD Evap. # Of Fans In Service	0		6	

3A	3B	4A	4B
3A1	3B1	4A1	4B1
3A2	3B2	4A2	4B2
3A3	3B3	4A3	4B3
3A4	3B4	4A4	4B4
3A5	3B5	4A5	4B5
3A6	3B6	4A6	4B6
3A7	3B7	4A7	4B7
3A8	3B8	4A8	4B8
3A9	3B9	4A9	4B9
3A10	3B10	4A10	4B10

Atlas Coppco @ CEMS Shack	Winding Q	Liquid Q	Pressure	Level	Voltage
Tank Z	116	psi			440
Filter D/P's (x3)	0	psi			440
Comp Out Z	114	psi			440
Max Z	132	psi			440
Running Hours	28076				440
Loaded Hours	17578				440
Motor Starts	1985				440
Module Hours	31754				440
Element Out Q	203	*F			440
Opacity Reading In CEMS Shack	1.33	%			440
Stack Lights Indicator Panel In Alarm	Yes	NO			440
TP3AA1					440
TP3AA2					440
TP3BB1					440
TP3BB2					440
TP4AA1					440
TP4AA2					440
TP4BB1					440
TP4BB2					440

Princp Switchgear Room	C3	C4
Fan Panel Power	ON	OFF
BH Heat Trace Panel Alarm In	YES	NO
Baghouse H.S.A. Tanks Z	110	psi
Baghouse Inst. Air Tank Z	108	psi
Aeration Blower Discharge Z	5	psi
Aeration Blower Discharge Q	175	*F

Reverse Gas Fans	3A	3B	4A	4B
Oil Levels IB / OB Bearings	HI	OK	LOW	HI
ACW Flow IB / OB Bearings	2.2	2.4	2.6	2.4
Inlet/Outlet Linkage Intact	YES	NO	YES	NO
ACW Lines Vented	C3	YES	C4	YES

Economizer Hoppers Checked	25	26	27	28	29	30
	✓	✓	✓	✓	✓	✓

Dragonair Oil Level	C3	HI	OK	LOW
	✓			

24" RETURN LINE LOW FLOW SYMPTOMS AND SHOCK CHLORINATION PROCEDURES

The 24" return line can normally handle all water requirements while pulling bottom ash on both units. As the weather warms up, Algae forms inside the lining of the 24" return line. This Algae restricts the flow of water returning to the bottom ash cell. Depending on the thickness of the build up, it can cause problems at the pond and at the ash water pump cell and drain cell. The noticeable symptoms start very slowly, and then things start to go wrong at the drain cell and ash water pump cell. Some symptoms are as follows:

1. The pond level starts rising a little bit every day, its hardly noticeable.
2. The water level at the pond overflow gradually starts getting higher and higher. A couple of inches above the overflow can be considered normal. Five inches or more, everyone should watch it closely.
3. The vortex or swirl around the concrete plug will get more and more sluggish as the algae build up gets thicker. Check the vortex only when you are pulling bottom ash. A normal vortex will swirl rapidly around the plug.
4. The flumes will start contributing more and more water to maintain the ash water pump cell level as the 24" return line flow becomes less. This will cause the pond level to rise, and explains the first two symptoms.
5. The instrument department will start getting complaints from operations that the pit levels will not maintain their normal operating levels.
6. This is what can cause serious problems----The Ash Water Pumps will start tripping out on low level trips. All of us tend to get complacent about low level trip outs on the pumps. We just simply go out to the pump and restart it. BUT WHAT IF IT WAS FROM ANOTHER CAUSE SUCH AS ELECTRICAL OR MECHANICAL TROUBLE. YOU COULD WIPE THE PUMP OR MOTOR OUT ON THE NEXT RESTART. Do not jeopardize your job by assuming that it was a low level trip out.

A J.T. DEELY
ASH OPERATOR DUTIES

1. OBSERVE ALL SAFETY RULES PERTAINING TO THE OPERATION OF THE ASH HANDLING SYSTEMS. USE ALL PROTECTIVE EQUIPMENT SUCH AS GOGGLES, DUST RESPIRATORS, GLOVES, ETC.
2. PULL FLY ASH AS PER THE PULLING SCHEDULE. PULL DIFFERENTLY IF CONDITIONS DICTATE TO DO SO.
3. THE ASH OPERATORS WILL OBSERVE AND INSPECT THE OPERATION OF BOTH SETS OF FLY ASH COLLECTORS, (A & B) FOR BOTH UNITS, ON TOP OF THE SILOS. THEY WILL INSPECT THE FLY ASH SYSTEM TRANSPORT LINES, VACUUM PUMPS, PRECIPITATOR PURGE AIR BLOWERS AND HEATERS, ETC. WHILE THE SYSTEMS ARE IN OPERATION.
4. TWICE A SHIFT CHECK PRECIPITATOR CONTROL ROOM, CABINETS, HEATERS, WIRE AND PLATE RAPPER SYSTEMS, AIR CONDITIONER AND GENERAL CLEANLINESS OF FLY ASH PRECIPITATOR CONTROL ROOM. ANYTHING ABNORMAL SHOULD BE REPORTED TO YOUR SUPERVISOR.
5. ONCE A SHIFT CHECK FLY ASH SILO UNLOADING AREA, AERATION BLOWER AND HEATER UNDER THE SILO AREA.
6. AT LEAST ONCE A SHIFT, OBSERVE AND INSPECT THE OPERATION OF THE ECONOMIZER DRAG CHAIN CONVEYING SYSTEM.
7. OBSERVE AND INSPECT ASH PUMP AND DRAIN PUMP SUMP AREA AT LEAST THREE (3) TIMES A SHIFT.
8. RUN ASH WATER DRAIN SUMP EDUCTORS (2) ONCE A MONTH FOR 30 MINUTES.
9. PULL BOTTOM ASH ONCE EACH SHIFT AT THE BEGINNING OF THE SHIFT. DO NOT LEAVE AREA FOR LONG PERIODS OF TIME WHEN THE SYSTEM IS IN OPERATION. FILL HOPPERS AS SOON AS POSSIBLE. DO NOT LEAVE EMPTY, UNNECESSARILY, FOR ANY LENGTH OF TIME.
10. ONCE A SHIFT, INSPECT PYRITE COLLECTION HOPPERS FOR COAL SPILLAGE, FIRES, TRAMP IRON, PYRITES, ROCKS, ETC. IF ANY COAL SPARKING IS SEEN IN THE PYRITE HOPPERS, NOTIFY SHIFT SUPERVISORS.
11. ONCE A WEEK, THURSDAY ON THE DAY RUN, FILL AND FLUSH PYRITE COLLECTION HOPPER SEAL CYLINDERS.
12. CHECK ASH POND LEVEL AND AREA ONCE A SHIFT.
13. ONCE A WEEK, WALK BOTTOM ASH DISCHARGE WATER LINES TO ASH POND INSPECTING FOR LEAKS.
14. CLEANING ASSIGNMENTS: CLEAN UP AT LEAST ONCE A WEEK OR MORE IF NEEDED

CITY PUBLIC SERVICE
SAN ANTONIO, TEXAS
CALAVERAS UNIT 5

**TURNKEY CONTRACT
DOCUMENTS**

VOLUME 4

**POWER PLANT EQUIPMENT
AND MATERIAL REQUIREMENTS**

BOOK 1

**DIV 50 - UNIT DESIGN AND PERFORMANCE
DIV 60 - GENERAL
DIV 61 - STRUCTURAL**

DEC 31 1987

**UTILITY ENGINEERING CORPORATION
H. B. ZACHRY COMPANY
COMBUSTION ENGINEERING, INC.**

Section 50.0200 - SITE DESIGN CONDITIONS

1.0 GENERAL. The Calaveras Unit 5 site conditions to be used as design and performance criteria shall be as described herein. These site design conditions shall be used for the design and selection of any equipment or materials furnished unless otherwise stated.

2.0 METEOROLOGY. The climate in the vicinity of the Calaveras Lake site is characteristic of the plains of south Texas. The site ambient conditions are summarized as follows.

Elevation	494 ft msl
Design ambient temperature	110 F maximum 0 F minimum
Dry- and wet-bulb temperature and duration	
Recorded dry-bulb (December - February)	99 percent of time above 25 F 97.5 percent of time above 30 F
Recorded dry-bulb and mean coincident wet- bulb (June - September)	1 percent of time above 99 F/72 F 2.5 percent of time above 97 F/73 F 5 percent of time above 96 F/73 F
Mean daily range (summer)	19 F
Design wet-bulb	1 percent of time above 77 F 2.5 percent of time above 76 F 5 percent of time above 76 F
Mean annual precipitation	29 inches

3.0 NATURAL PHENOMENA DESIGN CRITERIA. The design criteria based on natural phenomena shall be as follows.

3.1 Rainfall. The rainfall design basis may vary for the different systems and system components. The Contractor shall identify each building, system component, and the associated rainfall design basis in the Project Outline. The Project Consultant will provide information to the Contractor regarding the Coal Yard Facilities for inclusion in the Project Outline.

Precipitation amounts to be used with each design basis are listed in Table 50.0200-1 included herein for various durations and return periods. The data were obtained from the Rainfall Frequency Atlas of the United States, May 1961.

3.2 Wind Speed. The design wind speed shall be 80 miles per hour based on ANSI Standard A58.1-1982 for a 50 year recurrence interval. This design wind speed shall be used to determine wind loads for all structures except the concrete chimney. The design wind speed for the concrete chimney design shall be in accordance with the requirements for the chimney included in Section 61.1001 of these contract documents.

3.3 Temperature. Systems and system component design criteria which require ambient temperature extremes shall use the range from 0 F to 110 F for dry-bulb temperatures. Equipment such as oil-filled power transformers shall be designed for a maximum daily average temperature of 100 F.

3.4 Relative Humidity. The average annual relative humidity is 67 percent.

3.5 Barometric Pressure. The average annual barometric pressure is 29.49 inches Hg abs based on a site elevation of 494 feet above mean sea level.

3.6 Frost Depth. The "mean air freezing index" at the Calaveras Lake site is 0 degree-days. The index is defined as the cumulative number of degree-days below 32 F computed on the basis of mean air temperature data.

The "design freezing index" is 50 degree-days. This index is defined as the cumulative number of degree-days with air temperature below 32 F for the coldest year in a 10 year cycle, or the average of the coldest 3 years in a 30 year cycle. (The above information was extracted from the Army Technical Manual TM5-818-2, Pavement Design for Frost Conditions, July 1965.)

The relationship between air freezing index and frost penetration for various types of soils and surface cover is shown on Figure 50.0200-1 included herein, as extracted from the Army Technical Manual TM5-852-6, January 1966.

Frost protection for footings, pipes, and other frost susceptible structures shall be designed according to the above criteria; however, unless special localized conditions exist, 2 feet shall be used for frost penetration design.

Yard fire water mains shall be installed with top of pipe not less than 1 foot below the design frost penetration depth in accordance with National Fire Protection Association Standard 24.

TABLE 50.0200-1. PRECIPITATION AMOUNTS FOR SELECTED DURATIONS AND RETURN PERIODS EXPECTED IN THE CALAVERAS LAKE SITE AREA

<u>Duration</u> hours	<u>Return Period</u>				
	<u>5 Year</u> inches	<u>10 Year</u> inches	<u>25 Year</u> inches	<u>50 Year</u> inches	<u>100 Year</u> inches
1/2	1.95	2.32	2.68	3.02	3.35
1	2.44	2.92	3.38	3.80	4.25
2	3.03	3.58	4.21	4.69	5.29
3	3.33	3.97	4.63	5.25	5.86
6	4.00	4.77	5.67	6.29	7.13
12	4.75	5.63	6.68	7.64	8.54
24	5.41	6.60	7.75	8.80	9.92

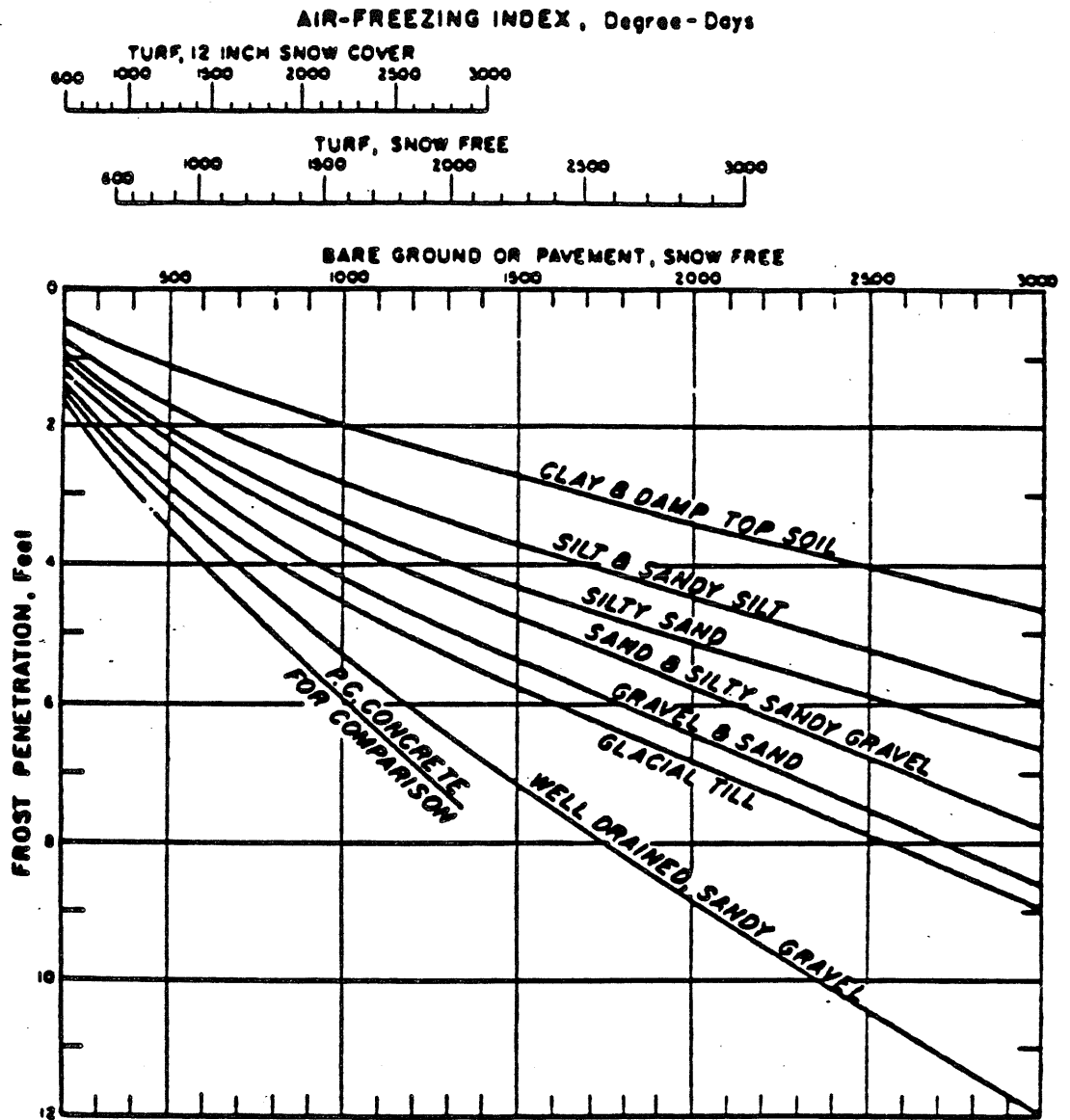

Relationship between air-freezing index, surface cover, and frost penetration into homogeneous soils

FIGURE 50.0200-1

3.7 Seismicity. The Calaveras Lake site is located in Risk Zone 0, as determined from Figure 13 of ANSI Standard A58.1-1982.

3.8 Soil Resistivity. An onsite soil resistivity survey shall be performed by the Contractor. Information regarding soil resistivity is required for design of the station grounding system and to determine the requirements for cathodic protection of underground piping. The results of the survey shall be documented in the Project Outline to be provided by the Contractor as described in Volume 2.

3.9 Soil Borings. The Contractor shall be responsible for all soil borings and geotechnical analysis of soil borings. Any soil boring information provided by the Owner is for the Contractor's information only. Information regarding soil borings and their effect on design of the power plant systems shall be documented in the Project Outline to be provided by the Contractor as described in Volume 2.

4.0 DESIGN WATER QUALITY. The water supplies to the Calaveras Lake site are from the lake and from a city water main.

4.1 Lake Water. The design water quality to be used for all equipment, materials, and processes using untreated lake water shall be as follows.

<u>Constituent</u>	<u>Design Value</u>	<u>Typical Range</u>
Calcium, mg/l as CaCO ₃	120	100 - 135
Magnesium, mg/l as CaCO ₃	107	95 - 115
Sodium, mg/l as CaCO ₃	182	85 - 230
Potassium, mg/l as CaCO ₃	24	20 - 27
Alkalinity, mg/l as CaCO ₃	156	140 - 180
Sulfate, mg/l as CaCO ₃	111	95 - 120
Chloride, mg/l as CaCO ₃	166	35 - 225
Silica, mg/l as SiO ₂	0.3	0.1 - 0.5
Iron, mg/l as Fe	0.14	0.07 - 0.22
pH	8.8	7.3 - 9.1
Conductivity, mmho/cm	847	820 - 875

Lake water temperature for design and performance guarantees shall be 95 F.

4.2 City Water. The design water quality to be used for all equipment, materials, and processes using city water shall be as follows.

<u>Constituent</u>	<u>Design Value</u>	<u>Typical Range</u>
Calcium, mg/l as CaCO ₃	187	175 - 195
Magnesium, mg/l as CaCO ₃	59	55 - 65
Sodium, mg/l as CaCO ₃	15	10 - 20
Alkalinity, mg/l as CaCO ₃	213	200 - 225
Sulfate, mg/l as CaCO ₃	26	23 - 30
Chloride, mg/l as CaCO ₃	21	18 - 23
Nitrate, mg/l as CaCO ₃	1	1 - 2
Silica, mg/l as SiO ₂	13	10 - 15
Iron, mg/l as Fe	<0.03	-
pH	7.7	7.2 - 8.1

Appendix D

Photographs

EPA Assessment - North and South Bottom Ash Pond Photos August 27 and 28, 2012



Photo 1: NP - North Embankment crest, looking east.



Photo 2: NP - North embankment interior slope, looking east.



Photo 3: NP - North embankment interior slope, looking east.



Photo 4: NP - North embankment exterior slope, looking north.

Note: NP - photographs related to the North Bottom Ash Pond
SP - photographs related to the South Bottom Ash Pond
NP/SP - photographs related to both the North and South Bottom Ash Ponds

EPA Assessment - North and South Bottom Ash Pond Photos August 27 and 28, 2012



**Photo 5: NP - North embankment exterior slope, looking northeast.
Note erosion near fence post.**



Photo 6: NP - North embankment interior slope, looking east.



Photo 7: NP - Outlet structure at northeast corner, looking east.



**Photo 8: NP - North embankment exterior slope, looking north. Calaveras
Lake in distance.**

EPA Assessment - North and South Bottom Ash Pond Photos August 27 and 28, 2012



Photo 9: NP - East embankment exterior slope, looking south.



Photo 10: NP - East embankment crest, looking south.



**Photo 11: NP - Outlet structure at northeast corner, looking west.
Outlet riser pipe.**



Photo 12: NP - East interior slope, looking south.

EPA Assessment - North and South Bottom Ash Pond Photos August 27 and 28, 2012



Photo 13: NP - East embankment interior slope, looking west. Note vegetation on slope.



Photo 14: NP - Loose ash material at east embankment interior slope.



Photo 15: NP - East embankment exterior slope, looking south.



Photo 16: NP - East embankment exterior slope, looking west.

EPA Assessment - North and South Bottom Ash Pond Photos August 27 and 28, 2012



Photo 17: NP - East embankment interior slope, looking south. Note erosion rills in ash material.



Photo 18: NP - Inlet piping, looking northwest. Piping includes one 8-inch diameter and two 12-inch-diameter pipes.



Photo 19: NP - Exterior slope at southeast corner, looking east.



Photo 20: NP - Interior slope at southeast corner, looking west.

EPA Assessment - North and South Bottom Ash Pond Photos August 27 and 28, 2012



Photo 21: NP/SP - Common embankment crest, looking west.



Photo 22: NP/SP - Common embankment south slope, looking west.



Photo 23: NP/SP - Erosion of ash material on common embankment north slope.



Photo 24: NP/SP - Erosion of ash material on common embankment south slope, looking northwest.

EPA Assessment - North and South Bottom Ash Pond Photos August 27 and 28, 2012



Photo 25: NP/SP - Vegetation and ash material on common embankment south slope.



Photo 26: NP/SP - Erosion of ash material on common embankment south slope, looking west.



Photo 27: NP/SP - Common embankment north slope, looking west.



Photo 28: NP/SP - Common embankment north slope, looking east. Slope measured approximately 3H:1V.

EPA Assessment - North and South Bottom Ash Pond Photos August 27 and 28, 2012



Photo 29: NP/SP - Common embankment crest, looking west.



Photo 30: NP/SP - Common embankment south slope, looking west.



Photo 31: NP/SP - Common embankment south slope, looking west.



Photo 32: NP/SP - Common embankment north slope, looking west.

EPA Assessment - North and South Bottom Ash Pond Photos August 27 and 28, 2012



Photo 33: NP - Inlet pipes at southwest corner. Piping includes one 8-inch diameter and two 12-inch-diameter pipes.



Photo 34: NP - 24-inch-diameter Plant return outlet, looking north.



Photo 35: NP - West embankment interior slope, looking northeast.



Photo 36: NP - North embankment interior slope, looking northeast.

EPA Assessment - North and South Bottom Ash Pond Photos August 27 and 28, 2012



Photo 37: NP - West embankment exterior slope, looking south.



Photo 38: NP - Erosion rill in ash material at west embankment interior slope.



Photo 39: NP - West embankment exterior slope, looking northeast.



Photo 40: NP - West embankment interior slope, looking northeast.

EPA Assessment - North and South Bottom Ash Pond Photos August 27 and 28, 2012



Photo 41: NP - West embankment exterior slope, looking north. Note area of loose soil/ash material.



Photo 42: NP - West embankment crest, looking northeast.



Photo 43: NP - Erosion of ash material at west embankment interior slope.



Photo 44: NP - West embankment exterior slope, looking north.

EPA Assessment - North and South Bottom Ash Pond Photos August 27 and 28, 2012



**Photo 45: NP - West embankment interior slope, looking northeast.
Note area of ash material on slope near northwest corner.**



**Photo 47: NP - Vegetation on north embankment exterior slope,
looking north.**



Photo 46: NP - Northwest corner exterior slope, looking south.



Photo 48: NP - North embankment exterior slope, looking west.

EPA Assessment - North and South Bottom Ash Pond Photos August 27 and 28, 2012



Photo 49: NP - North embankment exterior slope, looking west.



Photo 50: NP - North embankment exterior slope, looking west.



Photo 51: NP - Erosion on north embankment exterior slope, looking north.



Photo 52: NP - Erosion at fence post on north embankment exterior slope.

EPA Assessment - North and South Bottom Ash Pond Photos August 27 and 28, 2012



Photo 53: SP - East embankment exterior slope, looking south.



Photo 54: SP - East embankment interior slope, looking south.



Photo 55: NP/SP - Common embankment south slope, looking west.



Photo 56: SP - East embankment crest, looking south.

EPA Assessment - North and South Bottom Ash Pond Photos August 27 and 28, 2012



Photo 57: SP - Ash/soil pile on east embankment interior slope, looking south.



Photo 58: SP - East embankment exterior slope, looking south.



Photo 59: SP - East embankment interior slope, looking south.



Photo 60: SP - Exterior slope at southeast corner, looking south.

EPA Assessment - North and South Bottom Ash Pond Photos August 27 and 28, 2012



Photo 61: SP – Outlet structure at southeast corner interior slope, looking northwest.



Photo 62: SP - South embankment exterior slope, looking west.



Photo 63: SP – Approximately 3H:1V side slope at south embankment exterior slope.



Photo 64: SP - South embankment interior slope, looking west.

EPA Assessment - North and South Bottom Ash Pond Photos August 27 and 28, 2012



Photo 65: SP - South embankment crest, looking west.



Photo 66: SP - South embankment interior slope, looking west.



Photo 67: SP - Drainage ditch at south embankment exterior toe, looking west.



Photo 68: SP - South embankment exterior slope, looking west. Note equipment working in pond to replace inlet piping.

EPA Assessment - North and South Bottom Ash Pond Photos August 27 and 28, 2012



Photo 69: SP - Inlet piping at southwest corner interior slope, looking north.



Photo 70: SP - West embankment interior slope, looking north.



Photo 71: SP - Inlet piping at southwest corner interior slope, looking northeast.



Photo 72: SP - Exterior slope at southwest corner, looking west.

EPA Assessment - North and South Bottom Ash Pond Photos August 27 and 28, 2012



Photo 73: SP - West embankment crest, looking north.



Photo 74: SP - West embankment exterior slope, looking north.



Photo 75: SP - Spillway between SRH Pond and South Bottom Ash Pond at west embankment crest, looking north.



Photo 76: SP - Spillway between SRH Pond and South Bottom Ash Pond at west embankment interior slope, looking east.

EPA Assessment - North and South Bottom Ash Pond Photos August 27 and 28, 2012



Photo 77: SP - Spillway between SRH Pond and South Bottom Ash Pond at west embankment exterior slope, looking west.



Photo 78: SP - SRH Pond clarifier structure at west embankment crest, looking north.



Photo 79: SP - Spillway between SRH Pond and South Bottom Ash Pond at west embankment crest, looking north.



Photo 80: SP - Spillway between SRH Pond and South Bottom Ash Pond at west embankment interior slope, looking east.

EPA Assessment - North and South Bottom Ash Pond Photos August 27 and 28, 2012



Photo 81: SP - Spillway between SRH Pond and South Bottom Ash Pond at west embankment exterior slope, looking west.



Photo 82: SP - West embankment exterior slope, looking north.



Photo 83: SP - 24-inch-diameter Plant return outlet, looking east.



Photo 84: NP/SP - Common embankment south slope, looking east.

EPA Assessment - North and South Bottom Ash Pond Photos August 27 and 28, 2012



Photo 85: NP/SP - Discharge outfall 103C into Plant intake canal.



Photo 86: NP/SP - 12-inch-diameter piping at outfall 103C.



Photo 87: NP/SP - Discharge outfalls 103A and 103B into Plant intake canal.



Photo 88: NP - 12-inch-diameter piping at outfall 103A.

EPA Assessment - North and South Bottom Ash Pond Photos August 27 and 28, 2012



Photo 89: SP – 12-inch-diameter piping at outfall 103B.

EPA Assessment - Evaporation Pond Photos August 28, 2012



Photo 90: East Embankment crest, looking north.



Photo 91: East embankment interior slope, looking north.



Photo 92: Loose soils on east embankment exterior slope.



Photo 93: East embankment exterior slope, looking north.

EPA Assessment - Evaporation Pond Photos August 28, 2012



Photo 94: Loose soils on east embankment exterior slope.



Photo 95: East embankment exterior toe, looking north.



Photo 96: Loose soils near east embankment exterior toe.



Photo 97: East embankment exterior slope measured approximately 4H:1V.

EPA Assessment - Evaporation Pond Photos August 28, 2012



Photo 98: North embankment exterior slope, looking west.



Photo 99: North embankment exterior slope, looking west.



Photo 100: North embankment crest, looking west.



Photo 101: North embankment interior slope, looking west.

EPA Assessment - Evaporation Pond Photos August 28, 2012



Photo 102: East embankment interior slope, looking south.



Photo 103: North embankment exterior slope, looking east.



Photo 104: North embankment exterior slope, looking east. Note trees near exterior toe.



Photo 105: Trees at north embankment exterior toe, looking east.

EPA Assessment - Evaporation Pond Photos August 28, 2012



Photo 106: West embankment interior slope, looking south.



Photo 107: West embankment exterior slope, looking south.



Photo 108: West embankment crest, looking south.



Photo 109: West embankment exterior slope, looking southwest.

EPA Assessment - Evaporation Pond Photos August 28, 2012



Photo 110: Approximately 18-inch-deep animal burrow at west embankment exterior slope.



Photo 111: West embankment interior slope, looking south.



Photo 112: West embankment exterior slope, looking south.



Photo 113: Pond signage near southwest corner.

EPA Assessment - Evaporation Pond Photos August 28, 2012



Photo 114: South embankment crest, looking east.



Photo 115: South embankment interior slope, looking east.



Photo 116: South embankment exterior slope, looking southeast.



Photo 117: Exposed soil at south embankment exterior slope, looking north.

EPA Assessment - Evaporation Pond Photos August 28, 2012



Photo 118: South embankment exterior slope measured approximately 3H:1V.



Photo 119: South embankment exterior slope, looking east.



Photo 120: South embankment interior slope, looking east.



Photo 121: South embankment exterior slope, looking east.

EPA Assessment - Evaporation Pond Photos August 28, 2012



Photo 122: Interior slope at southeast corner, looking northwest.

Appendix D Photo GPS Locations

Site: J.T. Deely Power Plant

Datum: NAD 1983

Coordinate Units: Degrees Decimal Minutes

Photo No.	Latitude	Longitude
1	N 29 18.566'	W 98 18.980'
2	N 29 18.565'	W 98 18.979'
3	N 29 18.565'	W 98 18.973'
4	N 29 18.572'	W 98 18.968'
5	N 29 18.574'	W 98 18.967'
6	N 29 18.568'	W 98 18.948'
7	N 29 18.565'	W 98 18.920'
8	N 29 18.569'	W 98 18.914'
9	N 29 18.567'	W 98 18.904'
10	N 29 18.565'	W 98 18.907'
11	N 29 18.563'	W 98 18.909'
12	N 29 18.560'	W 98 18.907'
13	N 29 18.550'	W 98 18.907'
14	N 29 18.547'	W 98 18.908'
15	N 29 18.543'	W 98 18.892'
16	N 29 18.538'	W 98 18.890'
17	N 29 18.528'	W 98 18.907'
18	N 29 18.526'	W 98 18.908'
19	N 29 18.489'	W 98 18.908'
20	N 29 18.486'	W 98 18.908'
21	N 29 18.483'	W 98 18.909'
22	N 29 18.481'	W 98 18.910'
23	N 29 18.484'	W 98 18.919'
24	N 29 18.478'	W 98 18.922'
25	N 29 18.479'	W 98 18.921'
26	N 29 18.479'	W 98 18.920'
27	N 29 18.484'	W 98 18.929'
28	N 29 18.483'	W 98 18.931'
29	N 29 18.483'	W 98 18.942'
30	N 29 18.481'	W 98 18.946'
31	N 29 18.480'	W 98 18.956'
32	N 29 18.483'	W 98 19.002'
33	N 29 18.484'	W 98 19.040'
34	N 29 18.484'	W 98 19.041'
35	N 29 18.487'	W 98 19.044'
36	N 29 18.496'	W 98 19.042'
37	N 29 18.501'	W 98 19.047'
38	N 29 18.506'	W 98 19.028'
39	N 29 18.509'	W 98 19.028'
40	N 29 18.510'	W 98 19.023'
41	N 29 18.517'	W 98 19.023'
42	N 29 18.521'	W 98 19.012'
43	N 29 18.528'	W 98 19.008'
44	N 29 18.540'	W 98 19.007'
45	N 29 18.550'	W 98 18.987'
46	N 29 18.561'	W 98 18.985'

Appendix D Photo GPS Locations

Site: J.T. Deely Power Plant

Datum: NAD 1983

Coordinate Units: Degrees Decimal Minutes

Photo No.	Latitude	Longitude
47	N 29 18.568'	W 98 18.898'
48	N 29 18.574'	W 98 18.901'
49	N 29 18.574'	W 98 18.907'
50	N 29 18.573'	W 98 18.938'
51	N 29 18.572'	W 98 18.951'
52	N 29 18.572'	W 98 18.957'
53	N 29 18.483'	W 98 18.896'
54	N 29 18.476'	W 98 18.909'
55	N 29 18.478'	W 98 18.914'
56	N 29 18.471'	W 98 18.905'
57	N 29 18.461'	W 98 18.910'
58	N 29 18.451'	W 98 18.903'
59	N 29 18.452'	W 98 18.909'
60	N 29 18.429'	W 98 18.908'
61	N 29 18.417'	W 98 18.911'
62	N 29 18.413'	W 98 18.913'
63	N 29 18.412'	W 98 18.909'
64	N 29 18.416'	W 98 18.916'
65	N 29 18.415'	W 98 18.923'
66	N 29 18.415'	W 98 18.947'
67	N 29 18.406'	W 98 18.973'
68	N 29 18.418'	W 98 19.001'
69	N 29 18.419'	W 98 19.040'
70	N 29 18.422'	W 98 19.040'
71	N 29 18.421'	W 98 19.044'
72	N 29 18.424'	W 98 19.044'
73	N 29 18.430'	W 98 19.044'
74	N 29 18.436'	W 98 19.048'
75	N 29 18.449'	W 98 19.046'
76	N 29 18.451'	W 98 19.047'
77	N 29 18.454'	W 98 19.045'
78	N 29 18.456'	W 98 19.045'
79	N 29 18.468'	W 98 19.047'
80	N 29 18.473'	W 98 19.052'
81	N 29 18.473'	W 98 19.048'
82	N 29 18.474'	W 98 19.046'
83	N 29 18.479'	W 98 19.043'
84	N 29 18.481'	W 98 19.043'
85	N 29 18.403'	W 98 19.128'
86	N 29 18.399'	W 98 19.128'
87	N 29 18.384'	W 98 18.936'
88	N 29 18.376'	W 98 18.939'
89	N 29 18.380'	W 98 18.939'
90	N 29 19.396'	W 98 18.843'
91	N 29 19.406'	W 98 18.848'
92	N 29 19.407'	W 98 18.835'

Appendix D Photo GPS Locations

Site: J.T. Deely Power Plant

Datum: NAD 1983

Coordinate Units: Degrees Decimal Minutes

Photo No.	Latitude	Longitude
93	N 29 19.404'	W 98 18.836'
94	N 29 19.438'	W 98 18.839'
95	N 29 19.441'	W 98 18.829'
96	N 29 19.453'	W 98 18.831'
97	N 29 19.453'	W 98 18.836'
98	N 29 19.493'	W 98 18.852'
99	N 29 19.501'	W 98 18.850'
100	N 29 19.487'	W 98 18.852'
101	N 29 19.480'	W 98 18.858'
102	N 29 19.483'	W 98 18.858'
103	N 29 19.487'	W 98 18.948'
104	N 29 19.497'	W 98 18.923'
105	N 29 19.496'	W 98 18.909'
106	N 29 19.479'	W 98 18.928'
107	N 29 19.472'	W 98 18.938'
108	N 29 19.474'	W 98 18.932'
109	N 29 19.447'	W 98 18.932'
110	N 29 19.448'	W 98 18.937'
111	N 29 19.435'	W 98 18.923'
112	N 29 19.411'	W 98 18.926'
113	N 29 19.397'	W 98 18.919'
114	N 29 19.393'	W 98 18.909'
115	N 29 19.396'	W 98 18.910'
116	N 29 19.392'	W 98 18.906'
117	N 29 19.385'	W 98 18.907'
118	N 29 19.387'	W 98 18.906'
119	N 29 19.390'	W 98 18.891'
120	N 29 19.395'	W 98 18.882'
121	N 29 19.392'	W 98 18.870'
122	N 29 19.398'	W 98 18.847'